

**Thank you for choosing NIVELCO instrument
We are convinced that you will be satisfied with our product!**

NIPRESS

DRD-6□2-□

PRESSURE TRANSMITTER

User's Manual



Manufacturer: NIVELCO Process Control Co.
H-1043 Budapest, Dugonics u. 11.
Tel.: (36-1) 889-0100 Fax: 889-0200
E-mail: sales@nivelco.com www.nivelco.com

Dodávateľ: **MICROWELL spol. s r. o.**
SNP 2018/42, 927 00 Šafa
Tel.: (+421) 31 770 7585, 770 7587
E-mail: microwell@microwell.sk
<http://www.microwell.sk>

NIVELCO

1. APPLICATION

NIPRESS D-600 series pressure transmitters with ceramic flush sensor measure pressure and convert it into voltage and current output can be used in either 2- and 3-wire systems. The D-600 transmitters are suitable for the pressure measurement of fluids, oils, and gases. Due to their flush sensor, they are ideal for the measurement of viscous and polluted media. For using in aggressive media, we recommend PVDF process connection. Transmitters can be delivered with plug in display **UNICONT PLK-501** enabling on site reading. Ex or SIL versions are also available.

2. TECHNICAL DATA

GENERAL DATA

TYPE		DRD-6□2-2, -6, -C, -D	DRD-6□2-3
Measurement range		0 – 60 bar (0 – 870 psig) (according to the order code)	
Overload capability		According to the order code	
Accuracy		±0.5%	
Medium temperature ⁽¹⁾		-40 °C ... +125 °C (-40 °F ... +257 °F)	
Ambient temperature ⁽²⁾		-25 °C ... +85 °C (-13 °F ... +185 °F) (with integrated cable: -5 °C ... +70 °C [+23 °F ... +158 °F])	
Materials of the wetted parts	Sensor	Aluminium oxide ceramic Al ₂ O ₃ 96 %	
	Sensor sealing	FKM (Viton®) Optional: EPDM, NBR	
	Process conn.	Stainless steel 1.4404 (316L), Optional: PVDF	
Housing		Stainless steel 1.4404 (316L), Optional: Stainless steel 1.4301 (304), PVDF	
Output		2-wire 4 – 20 mA	3-wire 0 – 10 V
Power supply (U _{Supply}) ⁽²⁾		standard version: 8 – 32 V DC, SIL version: 14 – 28 V DC,	14 – 30 V DC
Load resistance		R _{max} = [(U _{Supply} - U _{Supply min.}) / 0.02 A], [Ω]	R _{min} = 10 kΩ
Process connection		3/4" BSP	
Electrical connection		ISO 4400, M12x1 (4-pin), integrated cable	
Ingress protection		IP65 (ISO 4400), IP67 (M12x1), IP68 (integrated cable with ventilation tube)	
Electric protection		Class III (SELV)	
Mass		~0.15 kg (~0.33 lb)	

⁽¹⁾ Permissible medium temperature for PVDF process connection must be between -30 °C ... +60 °C (-22 °F ... +140 °F)

⁽²⁾ For information of Ex certified devices, see Special data for Ex certified models' chart

2.1 ACCESSORIES

- User's manual
- Warranty Card
- EU Declaration of Conformity

SPECIAL DATA FOR EX CERTIFIED MODELS (ONLY FOR 4 – 20 mA / 2-WIRE)

Type	DRD-6□□-6 Ex,	DRD-6□□-D Ex
Ex marking ⁽¹⁾	(Pending.)	
Ex reference document number	(Pending.)	
Ex power supply	10 – 28 V DC	
Intrinsically safety data	U _{imax} = 28 V DC, I _{imax} = 93 mA, P _{imax} = 660 mW, C _i ≈ 0 nF, L _i ≈ 0 μH	
	The maximum interior capacity between the power supply connections and the metal housing is 27 nF.	
Permissible medium temperature, atmospheric pressure	Zone 0: -20 °C ... +60 °C (-4 °F ... +140 °F), 0.8 bar ≤ p _{atm} ≤ 1.1 bar	
	Zone 1, 2: -20 °C ... +70 °C (-4 °F ... +158 °F)	
Connecting cable (in case if the device equipped with an integrated cable)	Cable capacitance: 160 pF/m Cable inductivity: 1 μH/m	

⁽¹⁾ Only in case of stainless steel process connection!

2.2 ORDER CODE (NOT ALL COMBINATIONS POSSIBLE!)

NIPRESS

D R D - 6 □ 2 - □

MEASURING METHOD	CODE	PROCESS CONNECTION	CODE	RANGE ⁽¹⁾ / NOMINAL PRESSURE (bar)	CODE	ACCURACY	CODE	OUTPUT / EX	CODE
Gauge	R	3/4" BSP	D	0 – 0.4 / 1	3	0.5%	2	4 – 20 mA, 2-wire	2
				0 – 0.6 / 2	4			0 – 10 V, 3-wire	3
				0 – 1 / 2	5			4 – 20 mA, 2-wire / Ex ia ⁽²⁾	6
				0 – 1.6 / 4	6			4 – 20 mA, 2-wire, SIL2 ⁽²⁾	C
				0 – 2.5 / 4	7			4 – 20 mA, 2-wire, SIL2 / Ex ia ⁽²⁾	D
				0 – 4 / 10	8				
				0 – 6 / 20	9				
				0 – 10 / 20	A				
				0 – 16 / 40	B				
				0 – 25 / 40	C				
				0 – 40 ⁽³⁾ / 100	D				
				0 – 60 ⁽³⁾ / 200	E				

⁽¹⁾ Custom measuring range, based on prior negotiations

⁽²⁾ Ex or SIL versions are available upon special request

⁽³⁾ Only available with stainless steel process connection

Note:

In case of non-standard applications, the sensor type, sealing and housing, as well as the requirement for filling with food compatible oil has to be specified in the order!

2.3 DIMENSIONS

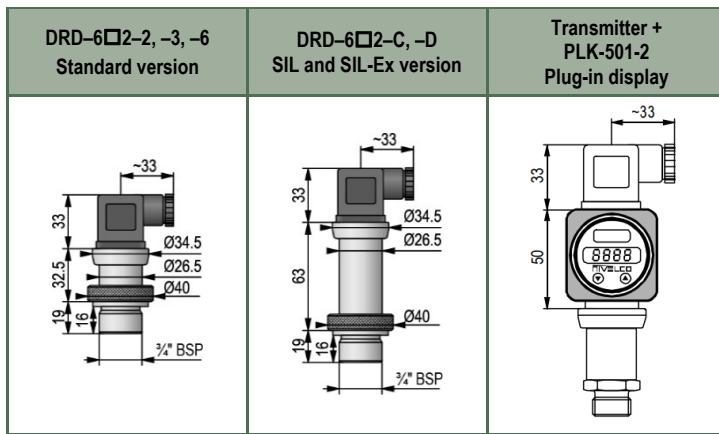

3. INSTALLATION

Due to its small size and weight the transmitter can be directly installed on tanks, pipes, machines, etc. without any mounting aids.

To enable the safe replacement of the instrument during operation the use of closing armature is recommended. A simple ball valve will be suitable for lower pressures and for higher pressures (above 6 bar) a three-way blow-off needle-valve can be suggested.

In case of outside installation, the unit should be protected against rain or splash water, because malfunction may occur from a leakage if the connector's screw is improperly tightened (i.e. not appropriate sealing).

3.1 INSTALLATION INSTRUCTION

The measured medium – depending on its type and properties, might be hazardous to the installer. Therefore, the wear of appropriate protective clothing, gloves, and goggles are recommended.

Be careful because the membrane is very vulnerable!

Torque should only be transferred to the hexagonal screw on the instrument body (torque wrench). **The cylindrical housing of the transmitter must not be gripped and tightened with a pipe wrench!**

The plug-in electric connector can be unplugged after releasing and removing its fastening screw. The connection insert can be pushed out by a screw driver from the direction of the screw. The terminal block can be rotated with 90° within the housing, so that the orientation of the cable gland could be changed to face downwards. This is to prevent any leakages of the housing and subsequent damages may occur. The power cable is to be connected with the relevant points of the connector by guiding it through the cable gland (ISO 4400). Make sure if the cable gland and the sealing plate of the connector tightened properly! Tighten the screw of the connector so that the sealing plate underneath seals properly!

For the sake of noise suppression, the transmitter housing is grounded. If the grounding of the process is correct no further grounding is needed, otherwise the instrument should be grounded.

When installing the device, avoid high mechanical stresses on the pressure port! This is particularly true for the pressure port made of plastic.

Installation steps:

Tightening torques:

3/4" BSP: max. 15 Nm;

The specified tightening torques must not be exceeded!

Mounting steps for BSP thread connections according to DIN 3852:

Do not use any additional sealing material such as Teflon tape! Check if the O-ring is undamaged, it has a flawless and clean surface and seats in the designated groove properly. Screw the device into the corresponding thread by hand, and tighten the parts with a suitable torque wrench.

If your device can be secured with a knurled ring, the pressure transmitter should only be tightened by hand!

4. WIRING

Use a shielded and twisted multicore cable for the electrical connection. Electrically connect the device according to the "Connection of ISO 4400 plug" figure. For devices with cable gland, make sure that the external diameter of the cable used is within the allowed clamping range! Once connected the wires, tighten the gland screw firmly until the sealing is proper!

For the installation of a device with an integrated cable, the bending radii have to comply with the following:

Cable without ventilation tube:

- static installation: 8-fold cable diameter,
- dynamic application: 12-fold cable diameter.

Cable with ventilation tube:

- static installation: 10-fold cable diameter,
- dynamic application: 20-fold cable diameter.

In case of devices with cable outlet and integrated ventilation tube, the PTFE filter located at the cable end on the ventilation tube must not be damaged or missing!

2-wire current output

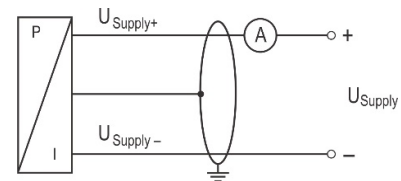

3-wire voltage output

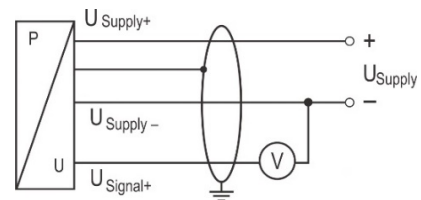

Connection of integrated cable

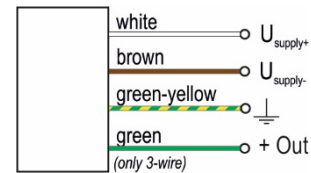

Connection of iso 4400 plug

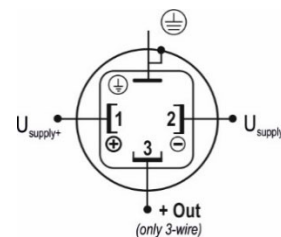

Connection of M12x1 / 4 pin plug

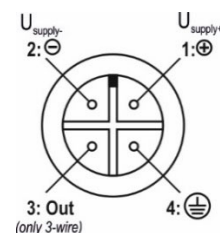

4.1 EXAMPLES OF ARRANGEMENTS

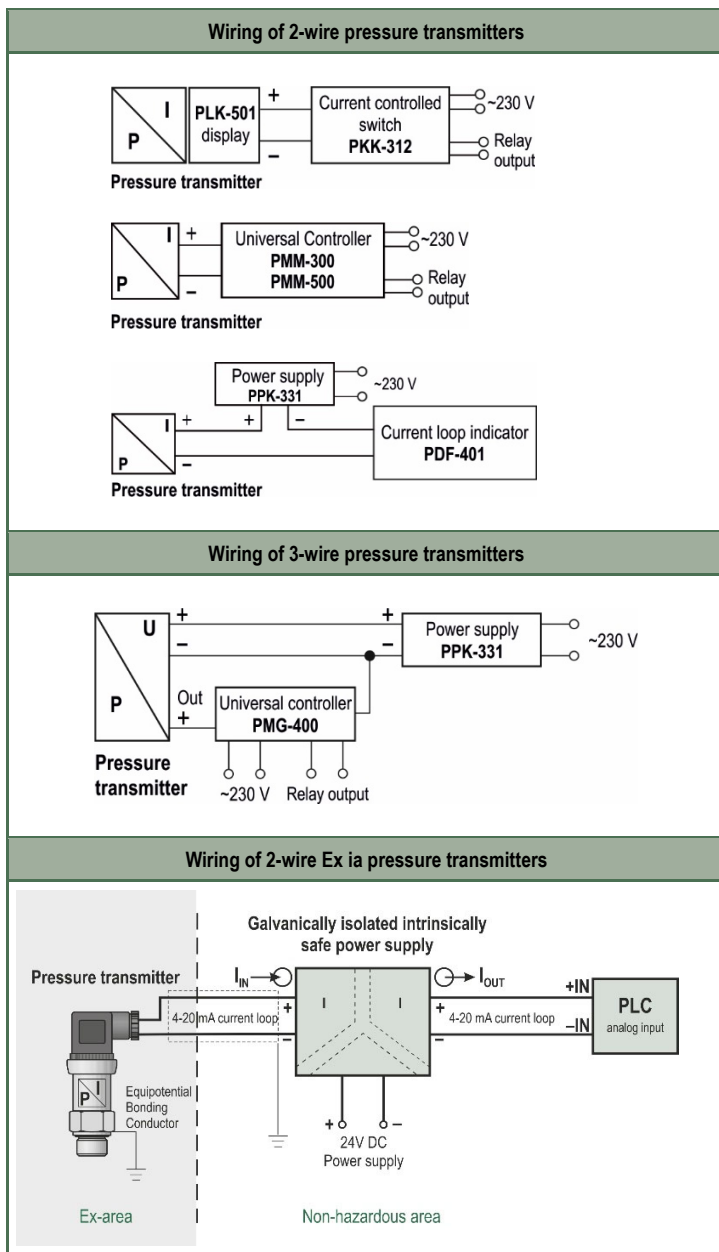

5. SPECIAL CONDITIONS OF SAFE USE



- Before turning on the device, make sure the installation is complete, with no effects visible.
- The device may only be used within the limitations specified in the technical specifications.
- The electrical connection of the device must be carried out in a way that the IP20 ingress protection is always ensured.
- Ex ia certified transmitters may only be operated in certified and approved galvanically isolated intrinsically safe Ex ia circuits complying with the technical data and the device's explosion protection marking!
- The metal housing of the device must be connected to the EP (equipotential) network!
- **Attention!** The devices may partially contain static charging capable plastic components. The presence of electrostatic charges may cause a risk of spark generation and ignition and therefore electrostatic charges must be completely prevented!
 - Avoid friction on plastic surfaces!
 - Do not clean the device dry!
 - For example, use a wet duster.

6. TROUBLESHOOTING

Fault	Possible causes	Fault detection / remedy
No output signal:	Connected incorrectly.	Check the connections!
	Conductor/wire breakage.	Check all wires with cable tester!
	Defective measuring device (signal input).	Check the amperemeter (and its fuse) and the analogue input of the signal processing unit!
Analog output signal too low:	Load resistance too high.	Check the value of the load resistance!
	Supply voltage too low.	Check the power supply and power /current on the transducer/transmitter!
A slight shift of the output signal:	The diaphragm of the sensor is severely contaminated.	Cleaning with non-aggressive cleaning solutions, soft brush or sponge.
	The diaphragm of the sensor is calcified or crusted.	It is recommended to clean carefully and remove dirt.
A large shift of the output signal:	The diaphragm of the sensor is damaged (caused by overpressure or mechanically).	Check the diaphragm of the sensor, if it is damaged send the device back to the manufacturer!

7. MAINTENANCE AND REPAIR

The instrument does not require regular maintenance. The repair should only be carried out at NIVELCO's premises.

When disconnecting the device, it must always be done in depressurized and disconnected state! Drain the medium before disconnecting the device. If necessary, clean the diaphragm carefully with non-aggressive cleaning solution, soft paint-brush or sponge. Improper cleaning may cause the irreparable damage of the diaphragm. For this reason, never use sharp objects or pressurized air for cleaning the diaphragm.

Before returning your device for repair, it has to be cleaned carefully, neutralize/decontaminate the parts wet from the medium might contain harmful substances.

Our official form (Returned Equipment Handling Form) must be enclosed after downloaded from our homepage www.nivelco.com. You should dispatch the device with a declaration of decontamination. In the declaration, you have to provide a statement that the decontamination process is completed, and the device is clean and free from harmful material and there is no hazardous substance on it.

8. STORAGE CONDITIONS

Storage temperature: -40 °C ... +100 °C (-40 °F ... +212 °F)

drd6322a0600h_01
July 2020.

NIVELCO reserves the right to change technical data without notice!