

MI  
CROWELL  
NIVELCO

# NIVOPRESS

DT- and DB- pressure transmitter and  
pressure transmitter for level

Installation and programming manual  
6<sup>th</sup> edition



Dodávateľ:

**MICROWELL spol. s r. o.**  
SNP 2018/42, 927 00 Šaľa  
Tel.: (+421) 31/770 7585, 770 7587  
E-mail: [microwell@microwell.sk](mailto:microwell@microwell.sk)  
<http://www.microwell.sk>

Manufacturer:

**NIVELCO Process Control Co.**  
H-1043 Budapest, Dugonics u. 11.  
Phone: (36-1) 889-0100 ■ Fax: (36-1) 889-0200  
E-mail: [sales@nivelco.com](mailto:sales@nivelco.com) ■ [www.nivelco.com](http://www.nivelco.com)



BK116ATEX0014X ♦ dbf5512a0600p\_05 ♦ 2011

## PRINCIPLE OF LEVEL MEASURING BY HYDROSTATIC PRESSURE:

Providing constant density the level depends on the pressure head

$$P_{\text{hydr}} = 10^5 \rho \cdot g \cdot h$$

↓

$$h = 10^5 \frac{P_{\text{hydr}}}{\rho \cdot g}$$

↓

Possible maximum value of "h":  $h_{\text{max}} = 10^5 \frac{P_{\text{hydr.max}}}{\rho \cdot g}$

- $P_{\text{hydr}}$  [bar] = hydrostatic pressure
- $\rho$  [kg/m<sup>3</sup>] = density of the medium
- $g$  [m/s<sup>2</sup>] = gravitational acceleration
- $h$  [m] = distance between middle of the diaphragm and level of the medium
- $P_{\text{hydr.max}}$  = highest pressure value set in the default

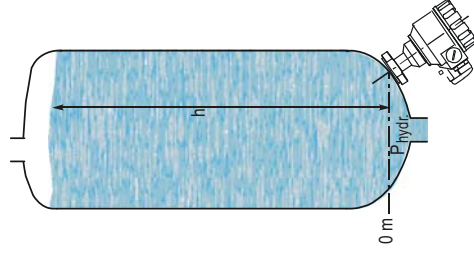
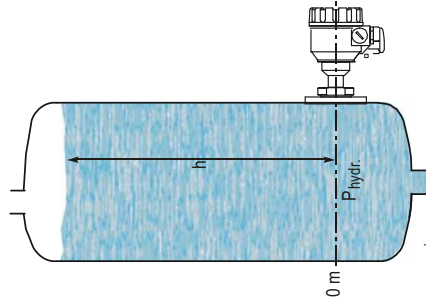



## CONTENTS

1	INTRODUCTION .....	5
2	ORDER CODES .....	5
3	TECHNICAL DATA .....	6
	3.1 GENERAL DATA .....	6
	3.2 DIMENSIONS .....	8
	3.3 ACCESSORIES .....	8
4	INSTALLATION AND ELECTRIC CONNECTION .....	9
	4.1 WIRING .....	10
	4.2 SAFETY REGULATIONS FOR THE EEX IA APPROVED UNITS .....	10
5	PUTTING INTO OPERATION, PROGRAMMING .....	11
	5.1 PROGRAMMING .....	12
	5.1.1 DISPLAY AND KEYS OF THE SAP 203 DISPLAY MODULE .....	13
	5.1.2 STEPS OF PROGRAMMING .....	14
	5.1.3 PARAMETERS – DESCRIPTIONS AND PROGRAMMING .....	15
	5.2 ERROR CODES .....	19
	5.3 HART COMMUNICATION .....	19
6	MAINTENANCE AND REPAIR .....	19
7	STORAGE .....	19
8	WARRANTY .....	19
	HIBA I A KÖNYVJELZŐ NEM LÉTEZIK .....	

**Thank you for choosing NIVELCO instrument**  
**We are sure that you will be satisfied throughout its use!**

## 1. INTRODUCTION

NIVOPRESS D-5/600 series transmitters are suitable for pressure and hydrostatic pressure (level) gauging of ordinary and hazardous gases, fumes, liquids and masses. Devices can be used for measuring in clean technologies and also for mediums tending to obturation. Intelligent electronics and HART communication provides application possibilities for the most different tasks.

## 2. ORDER CODES

### NIVOPRESS D - - - - - 1 - -

TYPE	CODE
Transmitter	T
Transmitter + display	B

PROCESS CONNECTION	CODE
1" BSP	E
1½" BSP	F
1" Triclamp	L
1½" Triclamp	M
2" Triclamp	N
DN 25 pipe c.*	O
DN 40 pipe c.*	P
DN 50 pipe c.*	R
1" NPT	S
1½" NPT	T

ELECTRONICS HOUSING	CODE
Aluminium	5
Plastic	6

RANGE / OVER PRESSURE CAPABILITY	CODE
-1 ... 0 bar / 3 bar	0
0 ... 0.16 bar / 0.5 bar	1
0 ... 0.25 bar / 1 bar	2
0 ... 0.4 bar / 1 bar	3
0 ... 0.6 bar / 3 bar	4
0 ... 1.0 bar / 3 bar	5
0 ... 1.6 bar / 6 bar	6
0 ... 2.5 bar / 6 bar	7
0 ... 4.0 bar / 20 bar	8
0 ... 6.0 bar / 20 bar	9
0 ... 10 bar / 20 bar	A
0 ... 16 bar / 60 bar	B
0 ... 25 bar / 60 bar	C
0 ... 40 bar / 100 bar	D
0 ... 60 bar / 120 bar	E
0 ... 100 bar / 250 bar	F
0 ... 160 bar / 500 bar	G
0 ... 250 bar / 500 bar	H
0 ... 400 bar / 600 bar	J

OUTPUT / EX	CODE
4 ... 20 mA	2
4 ... 20 mA / HART	4
4 ... 20 mA / Ex ia	6
4 ... 20 mA / HART / Ex ia	8

\*pipe coupling DIN 11581

- For range p > 0 ... 40 bar 1" process connection only

- Sealing: VITON p < 100 bar

NBR p ≥ 100 bar

EPDM for special request

- Pressure transmitting medium:

Silicone oil

Food compatible oil (for special request)

**Not all combination possible!**

### 3. TECHNICAL DATA

#### 3.1 GENERAL DATA

TYPE	DT0-□□1-□	DB0-□□1-□
Measured variables	Pressure, liquid level	
Sensor	Piezoresistive silicon sensor, with protection front diaphragm	
Ranges	In accordance with data in the order codes	
Overload capability	In accordance with data in the order codes	
Turn down	1 : 2	
Zero offset	50% of the range	
Output	4...20 mA or HART 4 ... 20 mA limits of the output signal: 3.9 ... 20.5 mA minimum loop resistance with HART Rt min = 250 Ohm	
Damping	selectable 3 s; 5 s; 10 s; 20 s	
Error indication by current output	3.8 mA or 22 mA	
Power supply	10 V ... 36 V DC	
Output load	$R_L = (U_s - 10 \text{ V}) / 0.022 \text{ A}$ , $U_s = \text{supply voltage}$	
Display	6-digit LCD, engineering units and bargraph. All variables can be displayed	
Accuracy (linearity, switching diff. repeatability)	relating to the higher limit value $\pm 0,25\%$ $p > 0.4$ ; $-1 < p \leq 0$ bar and $\pm 0,5\%$ for $0 < p \leq 0.4$ bar	

TYPE		DTD-□□1-□ DBD-□□1-□	
Temperature coefficient in the range of the compensated temperature (relating to the higher limit value)	Between 0 °C ... 70 °C	Between 0 °C ... 50 °C	
	≤ ± 0.75%	For the range of > 0 ... 1.0 bar, For the range of -1.0 ... 0 bar	≤ ± 1% For the range of 0 ... 0.4 bar
	≤ ± 1%	For the range of 0 ... 1.0 bar For the range of 0 ... 0.6 bar	≤ ± 1.5% For the range of 0 ... 0.25 bar ≤ ± 2% For the range of 0 ... -0.1 bar
Ambient temperature	-40 °C ... +70 °C with display: -25 °C ... +70 °C		
Medium temperature	-25 °C ... +125 °C		
Ex marking, Ex approved power supply data	$U_{max} \leq 30\text{ V}$ $I_{max} \leq 100\text{ mA}$ $P_{max} \leq 0.75\text{ W}$ $C_i \leq 14\text{ nF}$ $L_i \leq 180\text{ }\mu\text{H}$ II 1 G Ex ia IIC T6 ... T4 Ga		
Electric protection	Class III		
Ingress protection	IP 65		
Process connection	According to the order code		
Electric connection	Shielded cable pair with diameter $\varnothing$ 6 ... 12 mm (for the cable gland M 20 x 1.5) wire cross section: 0.25 ... 1.5 mm <sup>2</sup>		
Electronics housing	Paint coated aluminium (EN AC 42000) or plastic (PBT)		
Wetted parts	Protection front diaphragm: 1.4435 stainless steel Process connection: 1.4435 stainless steel sealing: VITON p < 100 bar    NBR p ≥ 100 bar    EPDM for special request		
Pressure transmitting medium	Silicone oil (for special request food compatible oil)		
Mass	approximately 2 kg with aluminium housing approximately 1.6 kg with plastic housing		

### 3.2 DIMENSIONS

TRANSMITTER WITH THREAD		TRANSMITTER WITH TRICLAMP		TRANSMITTER WITH PIPE COUPLING (DIN11581)	
TYPE	DTE-DBE-	DTF-DBF-	DTS-DBS-	DTT-DBT-	DTO-, DBO-, DTP-, DBP-, DTR-, DBR-
<b>A</b>	1" BSP	1 1/2" BSP	1" NPT	1 1/2" NPT	DN 25
<b>B</b>	193	185	197	189	DN 40
<b>C</b>	19	22	26	27	56
<b>D</b>	50	65	52	70	170
<b>SW</b>	44	55	40	55	186

Dimensions in mm

### 3.3 ACCESSORIES

- Installation and Programming Manual
- Warranty Card
- Declaration of Conformity
- 2 cable glands



#### 4. INSTALLATION AND ELECTRIC CONNECTION

- Place of installation should be selected so that proper place should be available for handling.
- Gauges measuring gases should be mounted to the highest point, liquids to the lowest points of the tank or pipe.

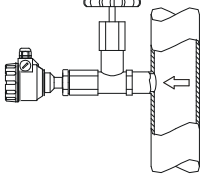
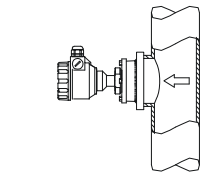
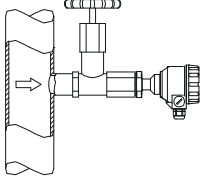
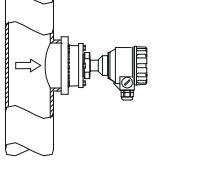
GASES		LIQUIDS	
			

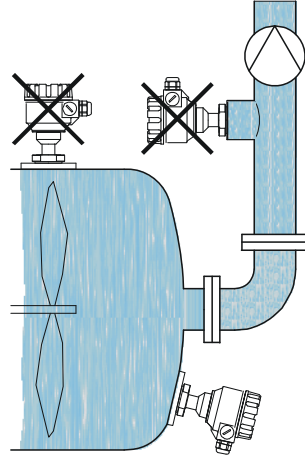

- Devices should not be installed in places with pressure waves involved for instance by stirrer or pumps.
- Device should be protected from direct heat (sun) radiation.
- Front diaphragm must not be pressed by hand or any object or cleaned with hard tool. Diaphragm protection cap can only be removed before installation!
- Devices with thread should be tightened with open-end wrench to the maximum torque of 35 Nm.
- After tightening the transmitter the rotatable housing can be rotated so that the cable gland will look down which is especially suggested in open air applications.

## 4.1 WIRING

- Transmitters are used in 2-wire systems with power supply of 10 ... 36 V DC. Resistance of the units in the loop depends on the voltage of the power supply.
- For wiring shielded cable suggested in the Technical Data should be used.
- After removal of the housing cover and taking out the display module (if any), the screw terminals can be accessed. Cover of the flame proof housing can be removed after unhooking the clamp.
- The unit should be grounded by the inner or outer grounding screw.
- Switch on the unit and make necessary programming.
- After programming ensure proper sealing and closing of the cover (and fastening of the clamp with the flame proof models).

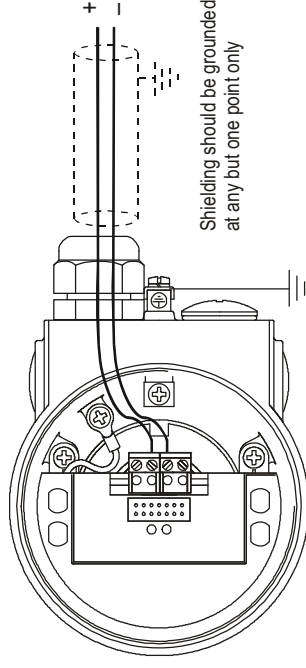

The unit may be damaged by electrostatic discharge (EDS) via its terminal, thus apply the precautions commonly used to avoid electrostatic discharge e.g. by touching a properly grounded point before removing the cover of the enclosure.

## 4.2 SPECIAL CONDITIONS FOR SAFE USE

Intrinsically safe units can only be used in certified intrinsically safe loops with the previously given technical data. (see values in Technical data table under Point 3.1).

Devices should be grounded by connecting their grounding screws to the equipotential system.

Equipment with plastic housing can be loaded electrostatically therefore the devices must be protected against electrostatic charges. The housing is allowed to clean only with wet rag.

Since the housing of the units is made of die cast aluminium, when the units are installed into a location which requires 'Ga' protection level, the units should be mounted that they are protected against impacts and friction effects which may be source of a potential ignition.

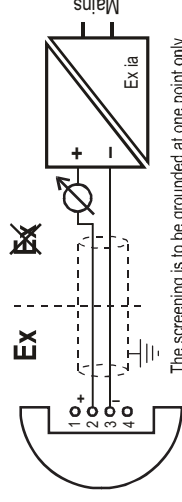

## 5. PUTTING INTO OPERATION, PROGRAMMING

Transmitter installed and wired correctly will after powering operate according to the settings of the Manufacturer (Default). Operability is indicated by lighting of the LED **VALID**.

The value of the actual loop current can be measured by a voltage meter (set for 200 mV range) with an accuracy of 0.5%. 4 mV corresponding to 4 mA and 20 mV corresponding to 20 mA. This procedure can not be used for calibration.

**WARNING!** During installation the zero point of the transmitter can possibly shifted. Therefore the zero point has to be checked and eventually be corrected as described in the programming (See P7 in 5.1.3).

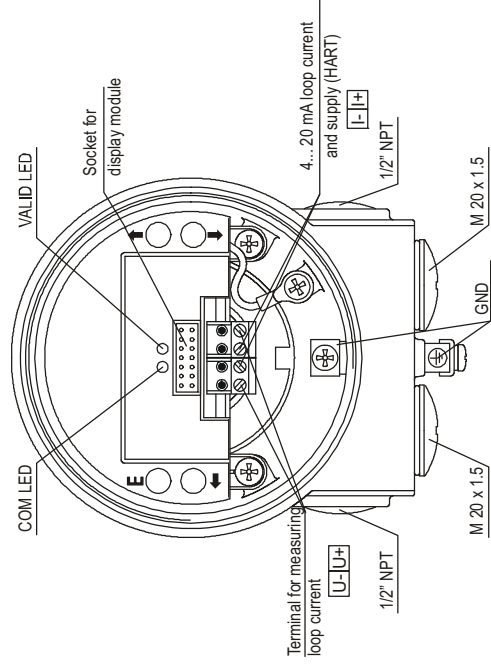

## 5.1 PROGRAMMING

Adjustment of the unit to the conditions of the application will be carried out by programming parameters with the aid of the push buttons and following the procedure on the display of the SAP-203 module. The NIVOPRESS is fully operational without the SAP-203 it is only needed for programming and/or displaying measurement values. Manufacturer's setting is as below:

### DEFAULT

- Measurement: pressure
- Engineering units: bar, for the range of  $p > 0.6$  bar  
mbar, for the range of  $p \leq 0.6$  bar
- Current output (4 ... 20 mA),
- Damping: 3 s
- Error indication:  $I_{\text{out}} = 3.8$  mA
- Noise suppression: 50 Hz
- Density: 1000 kg/m<sup>3</sup>
- Gravitational acceleration: 9.806 m/s<sup>2</sup>

NIVOPRESS DB□-□□□ types are incorporating SAP-203 display module but the types DT□-□□□ are not.

If the default is not meeting application requirements or the unit should be used for level measurement the programming i.e. modification of the parameters is needed. This can be performed with the SAP-203 display module. (Obviously for programming of the DT series the plug in of the SAP-203 module is necessary.)

**The unit will measure during programming in accordance with the parameters set previously. The new, modified parameters will only be effective after returning to the Measurement Mode.**

If the transmitter is left in Programming Mode by mistake, it will automatically return to Measurement Mode after 3 minutes and will operate with the parameters entered during the last completed programming.

### 5.1.1 Display and keys of the SAP 203 display module.

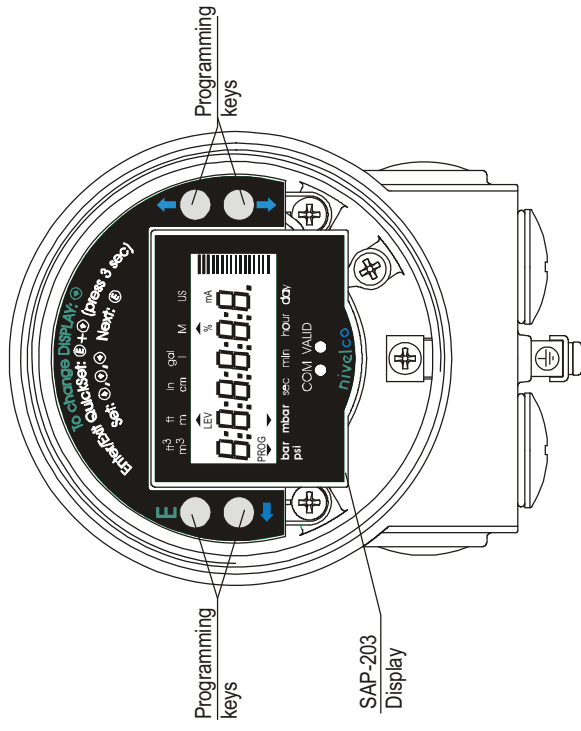

#### Symbols on the screen

- ▶ – pointer (showing to the relevant engineering unit)
- LEV – „ON” indicating level measurement mode
- mA – current output
- % – display in percentage
- PROG (blinking) – indicating programming

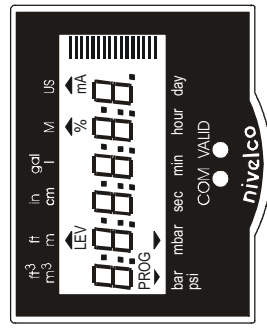

#### Symbols on the frame

- Pressure engineering units (bar, mbar, psi)
- Level engineering units (m, ft)
- M – metric (European) measurement system
- US – measurement system

### 5.1.2 Steps of programming

Programming will be performed by pressing and releasing the relevant one or two keys (simultaneously). The following description is for overview only, detailed programming is to find in 5.1.3



Y or YY parameter address (0, 1, ...19)  
 xxxx or xxxxx parameter value (dcba) or calibration/measurement value  
 ──── bargraph

For entering calibration values decimal point turns up automatically. Its position can not be changed

PROGRAMMING KEYS	OPERATION
Ⓔ + Ⓕ (press for min. 3 s) *	Enter or exit programming mode (Return to the Measurement mode means saving of the modifications)
Ⓕ + Ⓖ	GET VALUE – function for automatic setting. Actual/measured value will be accepted as value to be programmed.
<b>pressing Keys</b>	<b>while Parameter address blinking</b>
Ⓔ	to select parameter address and go to parameter value <b>while Parameter value blinking</b>
Ⓕ + Ⓖ	Cancel all modifications of the actual programming procedure CANCEL will be displayed for warning, pressing for 3 sec is required.
Ⓕ + Ⓖ	Reset all parameters to default. <b>LOAD</b> will be displayed for warning
Ⓕ	Move blinking (changeability) of the digit to the left
Ⓕ / Ⓖ	Modify the blinking digit (increase or decrease, minus sign) or scroll up/down ...8, 9, " - " 0, 1, 2, ...

**Double key pressing is indicated by "4"** \* **Make sure that Ⓔ would be pressed first!**

If after pressing Ⓔ blinking does not spring over from the parameter address to the parameter value this means that

- the parameter is either a read-out type, or
  - the secret code prevents the modification (see P19)
- If the modification of the parameter value is not accepted i.e. the parameter value keeps blinking after pressing ENTER Ⓔ,
- the modified value is either out of the range, or
  - the code entered is not a valid one

### 5.1.3 Parameters – descriptions and programming

**WARNING!** During installation the zero point of the transmitter may be shifted. It is suggested to make a correction in P7

**P0: - - - a Assignment of 4 mA to the measured (lowest) value**

**P1: - - - a Assignment of 20 mA to the measured (highest) value**

The lowest and highest (limit) value of the (pressure or level) range is to be assigned to the 4 and 20 mA output current. This can be performed by two methods

**a:** manually i.e. by entering the relevant values in P0 and P1 (Make sure that values to be programmed does not exceed the range of the unit in question, the modification of the parameter value will not be accepted i.e. after pressing  $\text{E}$  the parameter value will remain blinking.)

The procedure for assignment of 4 mA to 0 bar in P0: press  $\text{E}$  +  $\text{E}$  to enter programming mode, go to P0 with  $\text{V}$  +  $\text{V}$  and press  $\text{E}$  to go to parameter value, enter 0 as lowest pressure value and press  $\text{E}$  to go back to the parameter address, finally press  $\text{E}$  +  $\text{E}$  to exit programming/return to measurement mode).

**b:** automatically i.e. using the GET VALUE function at being in P0 and P1. This method for which the sensor should be put under the required (zero and high limit value) pressure or the relevant level in the tank should be available, provides higher accuracy.

FACTORY DEFAULT: limit values of the (pressure) range of the unit in question

**P5: - - - a Density [kg/m<sup>3</sup> or lb/ft<sup>3</sup>]**

Selectable between 600 and 2000 kg/m<sup>3</sup>

FACTORY DEFAULT: 1000 kg/m<sup>3</sup>

**P6: - - - a Gravitational acceleration [m/s<sup>2</sup> or ft/s<sup>2</sup>]**

For calculation of the level the gravitational acceleration should be entered if it is substantially different as the default value.

FACTORY DEFAULT: 9.806 m/s<sup>2</sup>

**P7: - - - a Zero point correction and offset**

As mentioned above the zero point correction is advised to perform once the unit is installed already. This can be best done with using the GET VALUE function in P7 having zero pressure on the sensor. (press  $\text{E}$  +  $\text{E}$  to enter programming mode, go to P7 with  $\text{V}$  +  $\text{V}$  and press  $\text{E}$  to go to parameter value, press  $\text{V}$  +  $\text{V}$  GET VALUE to make the unit recognise the actual 0 bar, press  $\text{E}$  to go back to the parameter address, finally press  $\text{E}$  +  $\text{E}$  to exit programming/return to measurement mode provided no other programming is needed)

With this procedure shift of the zero point will be displayed (with its – or + sign) and corrected.

The zero point of the transmitter can be shifted (offset) within and outside of the range, which might be useful instrument for special level gauging applications. This can also be performed in the parameter P7.

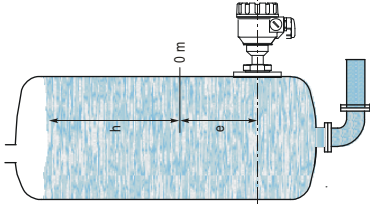

Zero point of the transmitter can be shifted up to the 50% of the range. Doing so the active measurement range will be reduced by the distance of „e“  
 Since in this case result will be achieved by deducting “e” from the measured level “h” for manual programming (provided the zero point has not been shifted during installation!) the value of the zero offset “-e” should simply be entered in P7.

With programming zero offset the possible zero point shift (occurred during installation) should also be taken into consideration with its mathematical sign. If for instance with the first switch-on checking of zero point in P7 would show a shift of for instance -0.027\* and zero point has to be offset by one meter -1 and ---- 0.027 i.e. -1.027 should be entered in P7

For automatic programming the required “0” level should be achieved and the GET VALUE used as described in section P1

\* this value with its - or + sign can be seen during **Zero Point Correction**

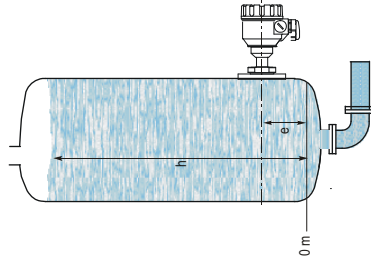

Zero point of the transmitter can also be shifted (offset) outside of the range. This is a virtual extension of the range by adding a dead zone of „e“ in which no measurement will take place consequently current output remains the same and the value of „e“ will be displayed. The measurement will only be active in the range of „h“ however the value of „e“ will be added to the level measured.

Since the result will be achieved by adding “e” to the measured level “h” for the manual programming (provided the zero point has not been shifted during installation!) the value of the zero offset “(+e)” should simply be entered in P7.

With programming zero offset the possible zero point shift (occurred during installation) should also be taken into consideration with its mathematical sign. If for instance with the first switch-on checking of zero point in P7 would show a shift of for instance -0.027\* and zero point has to be offset by one meter (+)1 and ---- 0.027 i.e. 0.973 should be entered in P7

Obviously in this case there is no place for automatic programming.

\* this value with its - or + sign can be seen during **Zero Point Correction**



**P9: - - - a Current generator test**

In this parameter the actual current output (corresponding to the measured process value) will be displayed. Pressing  $\text{\textcircled{E}}$  the blinking) current value can be set for any value between 3.9 and 20.5 mA. The current output has to show the same value.

**P10: - - - a Measurement mode**

a	Measurement mode
0	bar, mbar
1	psi
2	m
3	ft

(Hydrostatic pressure) Level measurement

FACTORY DEFAULT: 0

**P11: - dcba Rounding, noise suppression and displayed value**

Damping can be used to reduce unwanted fluctuation of the value displayed.

Noise suppression is to eliminate possible disturbance coming from the mains.

**Attention:** mind the sequence! When programming this parameter the right value "b" will be blinking first.

a	Rounding of displayed value
0	No
1	Yes

b	Damping
0	3 s
1	5 s
2	10 s
3	20 s

c	Noise suppression
0	50 Hz
1	60 Hz

d	Displayed value
0	Pressure or water head
1	Percentage

FACTORY DEFAULT: 000

**P12: - - - a Error indication by current output**

a	Error indication
0	3.8 mA
1	22 mA

FACTORY DEFAULT: 0

**P14: d c b a Software version**

The software number of your transmitter can be viewed in this parameter.

**P19: d c b a Secret code**

Settings can be protected by a 4 digit number (secret code) other than 0 entered as value of this parameter. If the secret code is active the symbol PROG is lighting and the value of the parameters can only be viewed. If there is no secret code or it is not active the symbol PROG is blinking.

For opening secret code the old code should be entered. For modifying or deleting (modifying to 0000) the new code can only be entered after opening the old code. The procedure is as below: Go to P19 press  $\text{E}$  to go to parameter value, enter the old code; press  $\text{E}$  to go to address and  $\text{E}$  again to return to value; enter new code or 0000.

FACTORY DEFAULT: 0000

## 5.2 ERROR CODES

In case of an error the LED VALID will be blinking, and Errx message will be displayed indicating the following errors:

Error Code (x)	Error description	Causes and solutions
0	Sensor error or exceeding default range by more than 10%	Contact local agent Modify programming
1	Memory error	Contact local agent
3	Programming error: same value in P0 and P1	Modify programming

## 5.3 HART COMMUNICATION

The HART capable transmitters can be programmed via the MultiCONT and the parameters, as well as the measured values, are transmitted via the RS485 communication line. In addition to that MultiCONT provides power supply to the transmitters.

## 6. MAINTENANCE AND REPAIR

The device does not require regular maintenance. In some instances, however, the diaphragm may need occasional cleaning. This should be done with care. All repairs within or beyond the warranty period are to be carried out solely by the manufacturer.

## 7. STORAGE

Ambient temperature: -25 °C ...+60 °C  
Relative humidity: max. 98 %

dbf5512a0600p\_06

January 2018

NIVELCO reserves the right to change technical data without notice.