



For more LG Therma V information,
please visit our website through
QR code.

2023

LG THERMA V™ PRODUCT CATALOGUE

2023 LG THERMA V™

PRODUCT CATALOGUE



Distributed by

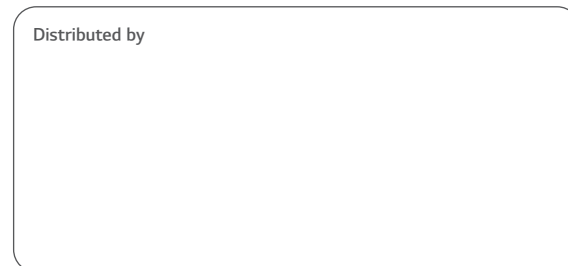

LG Electronics

www.lg.com <http://partner.lge.com>

Copyright © 2023 LG Electronics. All rights reserved.



INDEX

THERMA V™

INTRODUCTION

LG BUSINESS PARTNERSHIP & INFRASTRUCTURE	006
HEAT PUMP TECHNOLOGY	008
REGULATIONS & CERTIFICATIONS	010
THERMA V INTRODUCTION	014
WHAT IS LG THERMA V	016
LG AIR-TO-WATER HEAT PUMP SOLUTION OVERVIEW	018
THERMA V LINE-UP OVERVIEW	020
THERMA V LINE-UP INTRODUCTION	022
PRE-SALES/ENGINEERING TOOLS	028
ThinQ SEAMLESS CONNECTIVITY	032
LG BECON CLOUD SERVICE FOR THERMA V	034
LG SMART HOME ENERGY PACKAGE	038

FEATURES

FEATURE OVERVIEW	044
EXCELLENT PERFORMANCE & EFFICIENCY	046
USER CONVENIENCE	049
EASY INSTALLATION & MAINTENANCE	053

PRODUCTS

MONOBLOC

NEW R32 MONOBLOC S	058
---------------------------	-----

HYDROSPLIT

R32 HYDROSPLIT HYDRO BOX	076
R32 HYDROSPLIT IWT	088

SPLIT

NEW R32 SPLIT HYDRO BOX	100
NEW R32 SPLIT IWT	118
R410A SPLIT HYDRO BOX	140
HIGH TEMPERATURE	152

WATER HEATER

HEAT PUMP WATER HEATER	164
------------------------	-----

ACCESSORIES

ACCESSORIES PROVIDED BY LG	180
LG WI-FI MODEM	184
DOMESTIC HOT WATER TANK	185
COMBINED TEST WITH DHW TANK	186



#Care For Where You Live



THERMA V™



LG BUSINESS PARTNERSHIP & INFRASTRUCTURE

Infrastructure in Europe

LG Electronics' European Air Solution department is committed to ensuring your business success. With 16 pan-European sales offices and academies, we seek to deliver on our promise of support, efficiency and proactivity throughout each stage of our business partnership.

Our highly competitive products are delivered through our dedicated European distribution centre to ensure a steady and reliable supply of inventory.

At our European Energy Lab, LG Business Solutions is developing a heat pump technology that is optimized for the varied European climates and weather patterns along with continuous product performance verification.

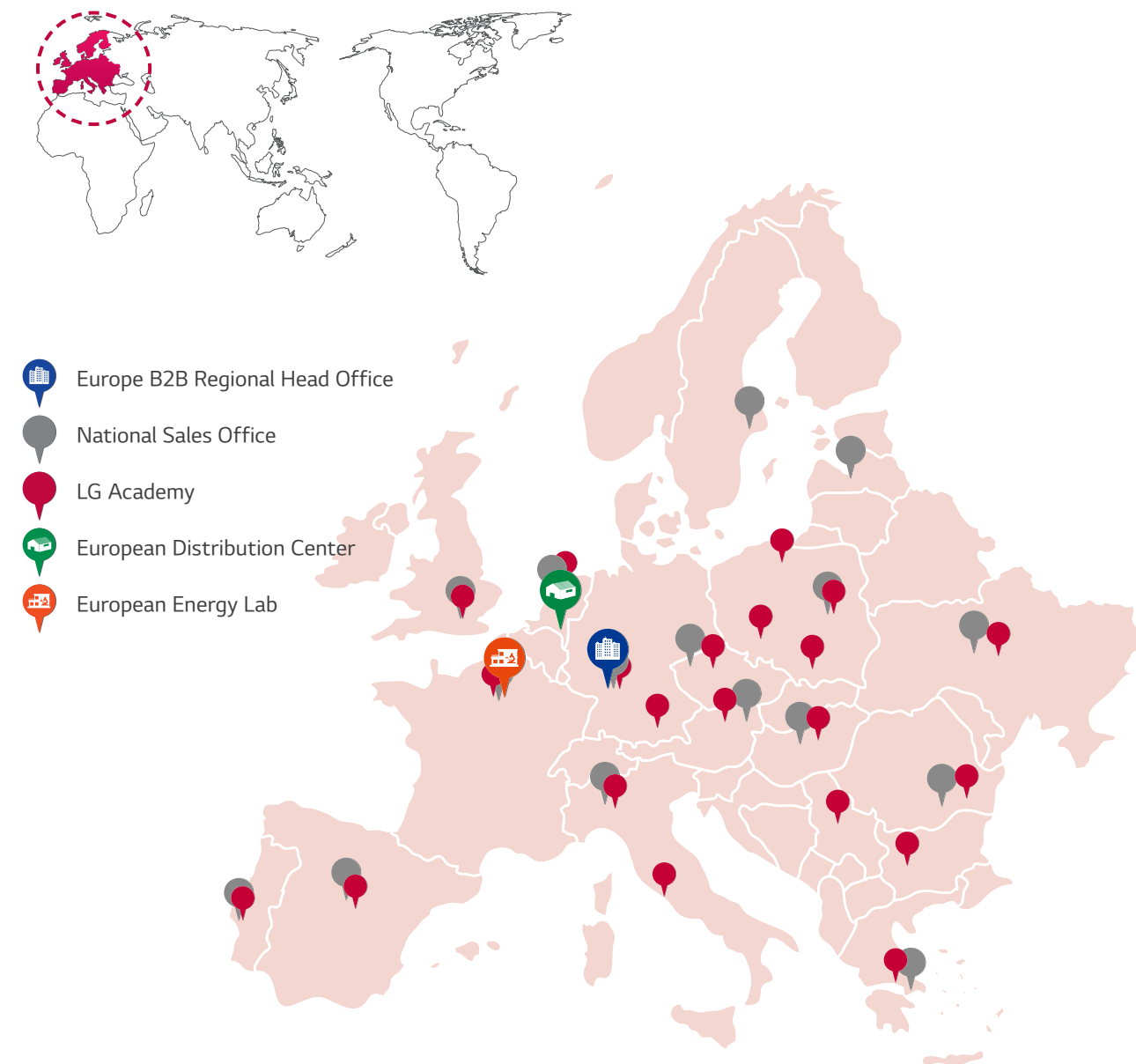

LG Europe B2B Regional Head Office

LG Business Solutions Europe is based in Eschborn, Germany, with regional offices located throughout Europe. LG Europe B2B Regional Head Office is a control tower for European B2B business dealing with a wide range of products, including heat pumps and air conditioners.

LG Electronics has a strong global network.

About LG Business Solutions:
<http://www.lg.com/global/business/about-lg-business>



LG Heat Pump and Air Conditioning Academy

LG has set up 20 official heat pump and air conditioning academies in Europe, teaching much needed skills to thousands of current industry professionals including installers, consultants, designers, sales staff and service technicians. The academy program is designed to share expertise and educate these HVAC experts by providing a cutting-edge technical experience with the newest and most advanced technologies and equipment. Moreover, as LG's entire product range is installed on site, professionals can be trained in a realistic way that offers them the chance to experience the latest products first-hand.



European Distribution Center

LG's European Distribution Center is located in Oosterhout, the Netherlands. Supplying products all over Europe, this distribution hub has contributed to smooth and rapid delivery, direct shipping for smaller orders and delivery tailored to air conditioners. Inventory efficiency of the hub is secured by the LG EU's established inventory pool.

HEAT PUMP TECHNOLOGY

LG Electronics Leads the Way in Heat Pump Technology

As a leading HVAC supplier, LG's heating product portfolio comprises a wide range of highly energy efficient renewable energy systems, providing the right heating solution for any type of requirements and/or buildings.

What is an Air-to-Water Heat Pump System?

Modern Technology to Replace Conventional Boilers

Historically, conventional heating systems have used either oil or gas or have represented direct electric heaters. In such conventional heating systems, environmental aspects such as the pollution produced by fossil fuel use have been overlooked. Over the last years, the interest in these environmentally friendly devices has been increasing and in order to respond to the growing demand for eco-conscious devices, LG has further developed its heat pump technology to produce more efficient, environmentally friendly products.

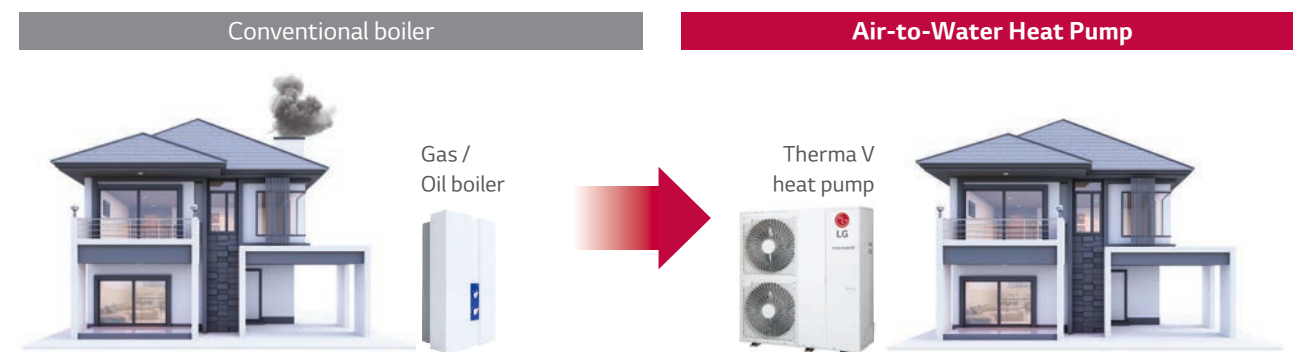

Modern Technology for Renewable Energy

The term "heat pump" refers to a technique that pumps heat from renewable energy sources, like the air, ground and water. A heat pump device transforms this energy into a usable heat source via the refrigerant cycle. With Therma V heat pump technology about 75% of the energy needed to provide heating and hot water comes from a natural air source.¹⁾

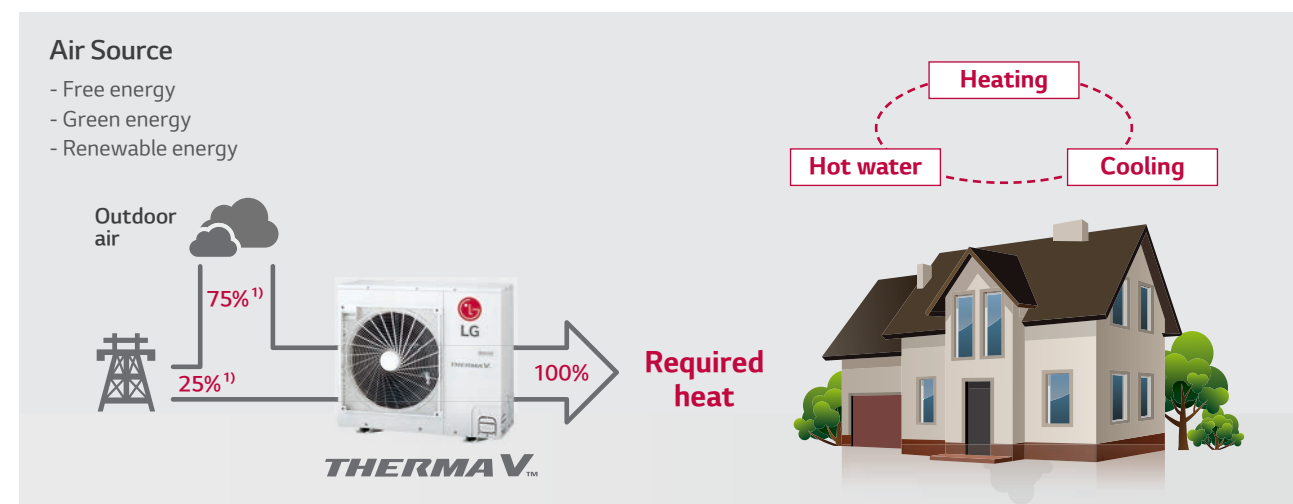

¹⁾ This is a general ratio based on LG Therma V R32 Series vs. electrical boiler under low temperature & average climate conditions, which may differ from actual operation.

How do Air-to-Water Heat Pumps Work?

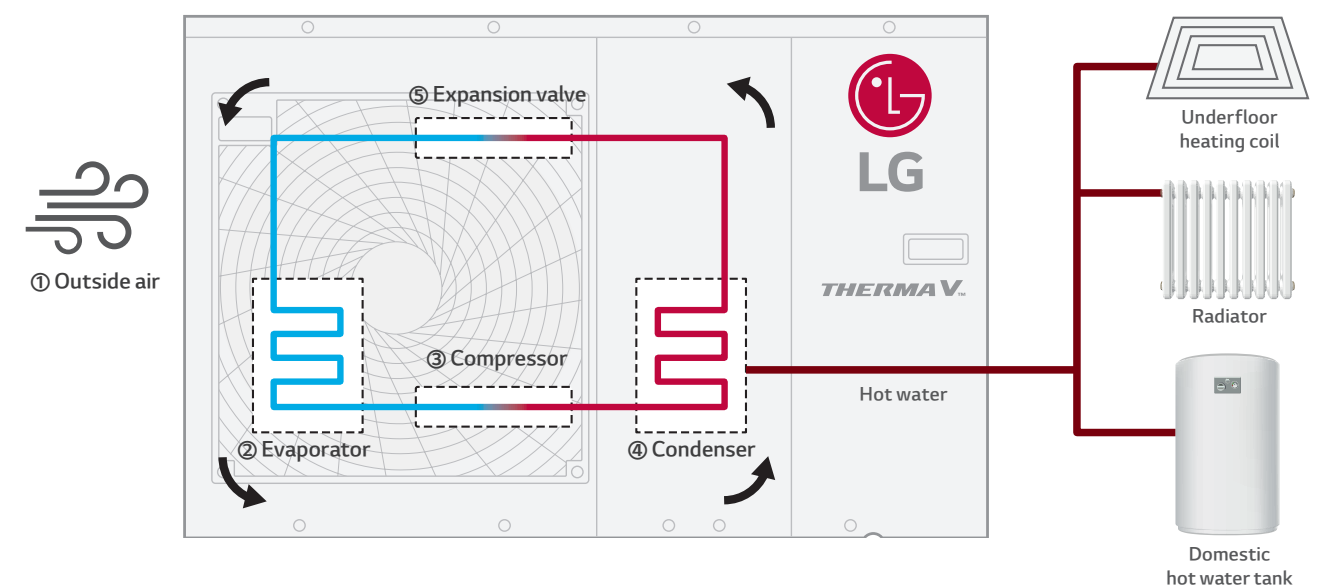

① Outside air

Heat is extracted from the outside air.

② Evaporator

As low temperature liquid refrigerant absorbs heat energy from the air, it transforms from liquid to vapor phase.

③ Compressor

The vaporized refrigerant flows into the compressor. The electric energy used to operate the compressor is converted into heat and added to the refrigerant.

④ Condenser

High temperature refrigerant gas flows into the heat exchanger and conveys heat energy to water by the heat exchanged between the refrigerant and water.

⑤ Expansion valve

High-pressure liquid refrigerant flows through the expansion valve to restore the refrigerant to its original condition.

REGULATIONS & CERTIFICATIONS

Energy Label

Energy labels

The EU energy label has been a key driver for helping consumers choose products which are more energy efficient. At the same time, it also encourages manufacturers to drive innovation by using more energy efficient technologies. The energy label was recognized by 93% of consumers and 79% considered it when buying energy efficient products, according to the special eurobarometer 492 carried out in the 28 EU member states during 2019.

Starting from 2013, the regulations apply to heat pumps, as well as to water heaters since 2015.

As of September 26th, 2019, the energy efficiency scale for seasonal space heating ranges from A+++ to D, with A+++ being the most efficient. The water heating energy efficiency scale for the declared load profile for combination heat pumps ranges from A+ to F, with A+ being the most efficient.

Information on the energy label

The energy labels provide minimum necessary information such as: manufacturer's name, manufacturer's model name, seasonal space heating energy efficiency class under average climate condition from A+++ to D in medium/low temperature applications (55°C/35°C), rated heat output under average, colder and warmer climate conditions in medium/low temperature applications (55°C/35°C), European map displaying the three temperature zones, the sound power level indoors and/or outdoors. In addition, just for combination heat pumps, the energy label also includes Water heating energy efficiency class under average climate condition from A+ to F at declared load profile, while the seasonal space heating energy efficiency class and rated heat output are indicated only for the medium temperature application (55°C).

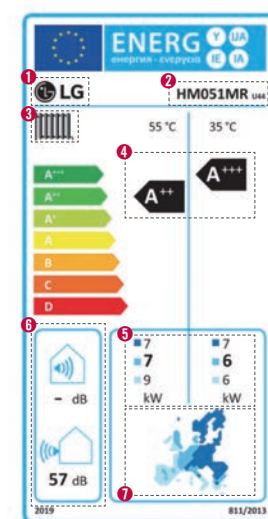

Heat pump space heaters

- 1 Manufacturer's name or trade mark
- 2 Manufacturer's model name
- 3 Space heating function
- 4 Seasonal space heating energy efficiency class under average climate condition from A+++ to D in medium/low temperature applications (55°C/35°C)
- 5 Rated heat output (kW) under average, colder and warmer climate conditions in medium/low temperature applications (55°C/35°C)
- 6 Operating noise for indoor and outdoor
- 7 European map displaying the three temperature zones

* This energy label may differ depending on local regulations (for example in the UK).

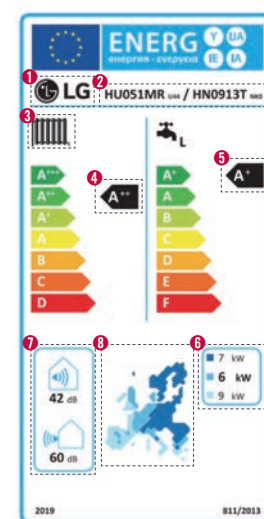

Heat pump combination heaters

- 1 Manufacturer's name or trade mark
- 2 Manufacturer's model name
- 3 Space heating function
- 4 Seasonal space heating energy efficiency class under average climate conditions from A+++ to D in medium temperature applications (55°C)
- 5 Water heating energy efficiency class under average climate conditions from A+ to F
- 6 Rated heat output (kW) under average, colder and warmer climate conditions in medium temperature application (55°C)
- 7 Operating noise for indoor and outdoor
- 8 European map displaying the three temperature zones

* This energy label may differ depending on local regulations (for example in the UK).

Nearly Zero Energy Building (nZEB)

Nearly Zero Energy Building

Nearly Zero-Energy Building (nZEB) means a building that has a very high energy performance, while the nearly zero or very low amount of energy required should be covered to a very significant extent by energy from renewable sources, including energy from renewable sources produced on-site or nearby. The Energy Performance of Buildings Directive (EPBD) requires that EU countries ensure that all new buildings are nearly zero-energy by the end of 2020, while all new public buildings had to be nearly zero-energy after 31 December 2018.

As concrete numeric thresholds or ranges are not defined in the EPBD, each EU member state defines their Nearly Zero-Energy Buildings (nZEB) in a flexible way, taking into account their country-specific climate conditions, primary energy factors, calculation methodologies, building traditions and current ambitions.

How LG Therma V supports to Nearly Zero Energy Buildings (nZEB)

In general, consultants use software programs to evaluate nZEB satisfaction of a new building. LG has been registering Therma V products in their database so that our Therma V products can be used directly in these software programs such as BENG in Netherland, SAP in UK and RE2020 in France.

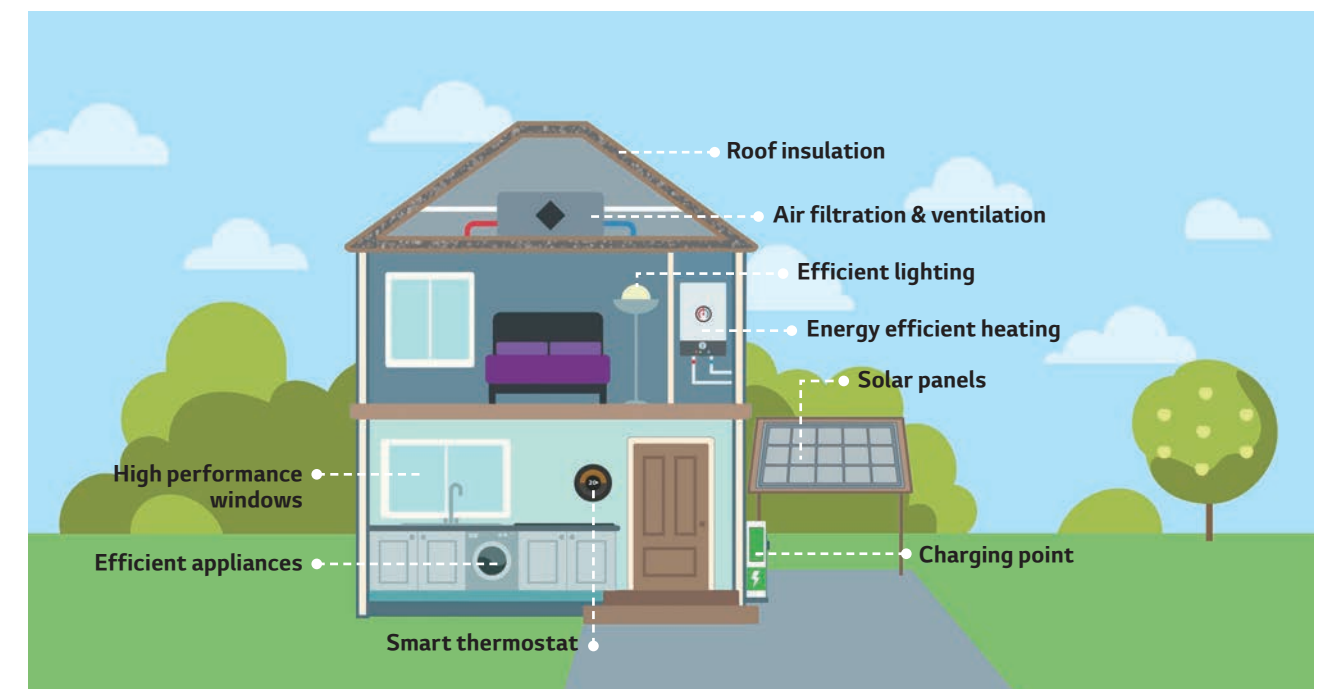

LG Therma V energy labels | Energy labels for each LG Therma V model can be found on the websites below.



LG.COM -
Compliance Information
<https://www.lg.com/global/support/cedoc/cedoc>



EPREL -
European Product Registry for Energy Labelling
<https://eprel.ec.europa.eu/screen/product/spaceheaters>



Netherland -
BENG
<https://bcrg.nl/nl/verklaringenregister/>



UK -
SAP
<https://www.ncm-pcdb.org.uk/sap/pcdbsearch.jsp?type=362&pid=31>



France -
RE2020
<https://www.edibatec.org/base-produits/>

REGULATIONS & CERTIFICATIONS

Certifications

All heat pumps and water heaters in the European market are continuously tested by various certification schemes. These are usually the basis for qualifying for subsidy programs in each country.

Keymark

<https://keymark.eu/en/products/heatpumps/certified-products>



The heat pump Keymark is a voluntary, independent European certification mark (ISO type 5 certification) for all heat pumps, combination heat pumps and hot water heaters (as covered by ecodesign, EU regulation 813/2013 and 814/2013). It is based on independent, third party testing and demonstrates compliance with product requirements as set in the heat pump Keymark scheme rules and with efficiency requirements as set by ecodesign lot 1 and lot 2.

The heat pump Keymark scheme is owned by the European committee for standardization (CEN).

The certificates are granted by independent certification bodies to products fulfilling all requirements of the scheme. LG Therma V products are certified with the heat pump Keymark. Please, refer to the web page above for details.

Eurovent

<https://www.eurovent-certification.com/en/>



Established in 1993, Eurovent certita certification is recognized as a world leader in third-party product performance certification in the heating, ventilation, air conditioning and refrigeration fields. Its major certification brand 'Eurovent Certified Performance' has become over the years a major European certification. Today over 67% of HVAC-R products sold in Europe hold this certification. LG Therma V products are certified with Eurovent. Please, refer to the web page above for details.

MCS

<https://mcs-certified.com/product-directory/>



MCS certification is a mark of quality and demonstrates compliance to industry standards. It is supported by the department for business, energy & industrial strategy of the UK. In particular, MCS certification demonstrates the quality and reliability of products in the renewable technology sector and it ensures that products are compliant with the UK regulations.

LG Therma V products are certified with MCS. Please, refer to the web page above for details.

EHPA

<https://www.ehpa.org/quality/quality-label/>



The EHPA quality label is a label that shows the end-consumer a quality heat pump unit or model range on the market. The heat pumps that receive the label need to undergo tests according to the international standard EN14511 and EN16147. These tests are executed by EN17025 accredited test centres. LG Therma V products are certified with the EHPA quality label for Austria, Germany and Switzerland. Please, refer to the web page above for details.

THERMA V™ INTRODUCTION

The Green Choice: THERMA V™

Discover the ultimate eco-conscious, energy efficient and convenient heating solution

Today's informed consumer will consider multiple factors when choosing a heating solution, like an Air-to-Water Heat Pump (AWHP or ASHP) to include user-friendliness, reliability and regulation-compliance. Shifting regulations year after year exceedingly impact the European customers' choice of heating products.

R32 refrigerant represents a new smart solution to the modern requirements. With a 68% reduced Global Warming Potential (GWP) from the currently widely used refrigerant, R410A, R32-applied products are not only eco-conscious but also meet the consumers' needs for energy efficiency, performance and more.

LG Electronics' Therma V R32 line-up fulfills both European regulations as well as customer needs.



- Ultimate energy efficiency: A+++ in the ErP energy labelling regulation, wide operation range, reduced noise level
- Excellent performance: R1 compressor embedded, high heating capacity at low ambient temperature
- User convenience: LG ThinQ Wi-Fi control, convenient scheduler, wider connectivity, energy monitoring

WHAT IS LG THERMA V?

For more LG Therma V information, please visit our website through QR code.



LG's Advanced Heating Technology

The LG Therma V Air-to-Water Heat Pump system boasts an advanced heating technology that can minimize energy consumption more than any other solution in the market. In addition, it has been specially designed to provide a valuable living space and domestic hot water supply to both new build and renovated homes.



THERMA V™

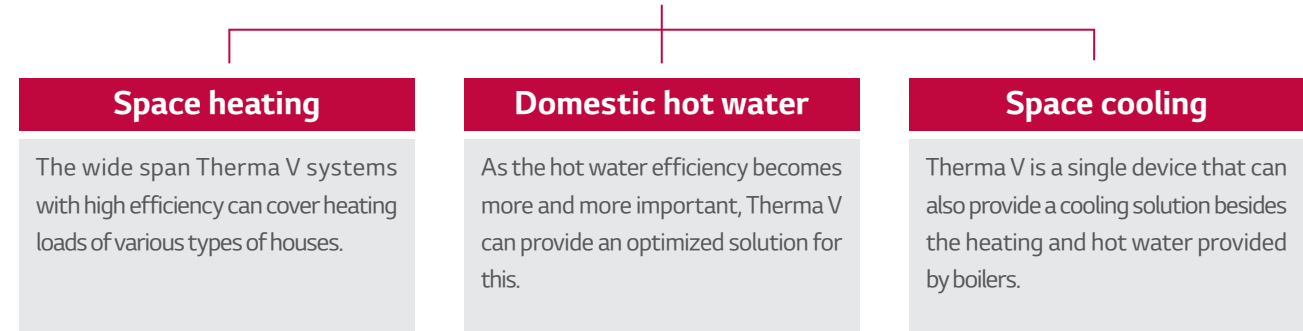

High Efficiency and Low CO₂ Emission

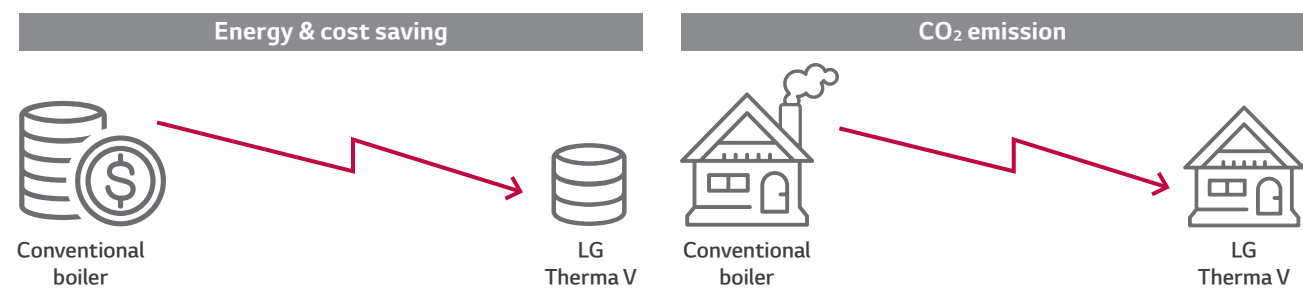

Benefits of LG Therma V



For homeowners

- Energy saving by utilizing renewable energy and high efficiency equipment
- Multiple solutions with space heating, cooling and DHW supply
- Economic support through domestic renewable heat incentive programs
- Investment cost savings thanks to the compatibility with existing heating system like radiator, boiler, etc.
- Valuable space savings with the small footprint
- No disturbing caused to neighbors with low noise
- Low repair cost and high reliability with durable equipment
- Convenient control by user-friendly remote controller
- Remote connectivity for control and monitoring via LG ThinQ



For consultants and designers

- Variety of software to support selection and designing Therma V
- Multiple solutions with space heating, cooling and DHW supply
- Wide leaving water temperature - compatible with various heat emitters
- Valuable space savings with the small footprint
- Excellent heating performance even at low ambient temperature
- Optimal system interoperability - open modbus with 3rd party controller
- Adapts operation to ESS battery output, maximizing self-consumption of locally produced PV energy

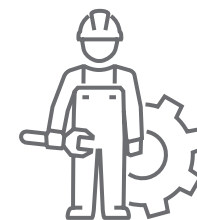

For installers and service providers

- Time savings with features for quicker installation and commissioning
- Less manpower for handling with the compact size and light weight
- Less service visit with high reliability and durable equipment
- Intuitive controller interface for all LG products, requiring less training
- Remote control, monitoring and diagnosis to avoid unnecessary site visits
- Clip connections for quick maintenance and no need for special tools

LG AIR-TO-WATER HEAT PUMP SOLUTION OVERVIEW















		Monobloc	Hydrosplit	
		Standalone - no indoor unit	Hydro Box (wall hung)	IWT (Integrated Water Tank)
Line-up		R32 Monobloc S	R32 Hydrosplit Hydro Box	R32 Hydrosplit IWT
		1 Ø: 5/7/9/12/14/16 kW 3 Ø: 9/12/14/16 kW	1 Ø: 12/14/16 kW 3 Ø: 12/14/16 kW	1 Ø: 12/14/16 kW 3 Ø: 12/14/16 kW
Application		Heating, cooling and DHW 	Heating, cooling and DHW 	Heating, cooling and DHW
Energy label		 Space heating: 35°C A ⁺⁺⁺ , 55°C A ⁺⁺ DHW heating: Combination with OSHW-200F (Profile L) A ⁺	 Space heating: 35°C A ⁺⁺⁺ , 55°C A ⁺⁺ DHW heating: Profile L A ⁺	 Space heating: 35°C A ⁺⁺⁺ , 55°C A ⁺⁺ DHW heating: Profile L A ⁺
Certifications				
Operation range (heating)	Outdoor air	-25 - 35°C	-25 - 35°C	-25 - 35°C
	Leaving water	15 - 65°C	15 - 65°C	15 - 65°C
Operation range (cooling)	Outdoor air	5 - 48°C	5 - 48°C	5 - 48°C
	Leaving water	5 - 27°C (16 - 27°C) ²⁾	5 - 27°C (16 - 27°C) ²⁾	5 - 27°C (16 - 27°C) ²⁾
Domestic hot water tank included		X	X	O (200 l)
Backup heater included		X (accessory)	X (accessory)	O
F-gas license needed		X	X	X
Wi-Fi remote control via ThinQ ¹⁾		O	O	O

1) Wi-Fi modem (PWFMD200) should be purchased and installed separately.
 2) When a fan coil unit is not used.
 3) Except for 3 Ø 9 kW model (HM093MR U44)
 4) 5, 7, 9, 12 kW models only (HM051MR U44, HM071MR U44, HM091MR U44, HM093MR U44, HM121MR U34, HM123MR U34)

		Split			Water heater	
		Hydro Box (wall hung)	IWT (Integrated Water Tank)	Floor standing	Water heater	
Line-up		R32 Split Hydro Box	R410A Split Hydro Box	R32 Split IWT	High Temperature	
		1 Ø: 4/6 kW (U24A) 1 Ø: 5/7/9 kW (U36A)	1 Ø: 12/14/16 kW 3 Ø: 12/14/16 kW	1 Ø: 4/6 kW (U24A) 1 Ø: 5/7/9 kW (U36A)	1 Ø: 16 kW	Heat Pump Water Heater
Application		Heating, cooling and DHW 	Heating, cooling and DHW 	Heating and DHW 	DHW 	
Energy label		 Space heating: 35°C A ⁺⁺⁺ , 55°C A ⁺⁺	 Space heating: 35°C A ⁺⁺⁺ , 55°C A ⁺⁺	 Space heating: 35°C A ⁺ , 55°C A ⁺	 DHW heating: 200 L Profile L A ⁺ , 270 L Profile L A ⁺	
Certifications						
Operation range (heating)	Outdoor air	4/6 kW: -20 - 35°C 5/7/9 kW: -25 - 35°C	-25 - 35°C	4/6 kW: -20 - 35°C 5/7/9 kW: -25 - 35°C	-25 - 35°C	-5 - 48°C
	Leaving water	4/6 kW: 15 - 55°C 5/7/9 kW: 15 - 65°C	15 - 57°C	4/6 kW: 15 - 55°C 5/7/9 kW: 15 - 65°C	25 - 80°C	35 - 65°C
Operation range (cooling)	Outdoor air	5 - 48°C	5 - 48°C	5 - 48°C	-	-
	Leaving water	5 - 27°C (16 - 27°C) ²⁾	5 - 27°C (16 - 27°C) ²⁾	5 - 27°C (16 - 27°C) ²⁾	-	-
Domestic hot water tank included		X	O (200 l)	X	O (200 / 270 l)	
Backup heater included		O	O	X	O	
F-gas license needed		O	O	O	X	
Wi-Fi remote control via ThinQ ¹⁾		O	O	O	O	

* MCS and EHPA label under development (4/6 kW model)
 * EHPA label under development
 * EHPA label under development (4/6 kW model)

LINE-UP OVERVIEW

Line-up	Unit	Power supply ¹⁾	Appearance	4 kW	6 kW	Appearance	5 kW	7 kW
R32 Monobloc S P.58	Set	1 Ø / 230 V					HM051MR U44	HM071MR U44
		3 Ø / 400 V						
R32 Hydrosplit Hydro Box P.76	Outdoor unit	1 Ø / 230 V						
		3 Ø / 400 V						
	Indoor unit	Common						
R32 Hydrosplit IWT P.88	Outdoor unit	1 Ø / 230 V						
		3 Ø / 400 V						
	Indoor unit	Common						
R32 Split Hydro Box P.100	Outdoor unit	1 Ø / 230 V		HU041MR U20	HU061MR U20		HU051MR U44	HU071MR U44
	Indoor unit			HN0613M NK5			HN091MR NK5	
R32 Split IWT P.118	Outdoor unit	1 Ø / 230 V		HU041MR U20	HU061MR U20		HU051MR U44	HU071MR U44
	Indoor unit			HN0613T NK0			HN0913T NK0	
R410A Split Hydro Box P.140	Outdoor unit	1 Ø / 230 V						
	Indoor unit							
	Outdoor unit	3 Ø / 400 V						
	Indoor unit							
High Temperature P.152	Outdoor unit	1 Ø / 230 V						
	Indoor unit							

1) The power supply is shown based on the outdoor unit.

Line-up	Power supply	Appearance	200 ℓ	270 ℓ
Heat Pump Water Heater P.164	1 Ø / 230 V		WH20S	
				WH27S

* Production of this product could be discontinued without prior notice considering manufacturer's circumstances.

9 kW	Appearance	12 kW	14 kW	16 kW
HM091MR U44		HM121MR U34	HM141MR U34	HM161MR U34
HM093MR U44		HM123MR U34	HM143MR U34	HM163MR U34
		HU121MRB U30	HU141MRB U30	HU161MRB U30
		HU123MRB U30	HU143MRB U30	HU163MRB U30
		HN1600MC NK1		
		HU121MRB U30	HU141MRB U30	HU161MRB U30
		HU123MRB U30	HU143MRB U30	HU163MRB U30
		HN1616Y NB1		
HU091MR U44				
HN091MR NK5				
HU091MR U44				
HN0913T NK0				
		HU121MA U33	HU141MA U33	HU161MA U33
		HN1616M NK5		
		HU123MA U33	HU143MA U33	HU163MA U33
		HN1636M NK5		
				HU161HA U33
				HN1610H NK3

LINE-UP INTRODUCTION



Therma V R32 Monobloc S

The Therma V R32 Monobloc S is the 2nd generation of LG's R32 Monobloc series. As implied by "silence" and "supreme," it boasts reduced noise level and best performance in the Therma V Series. Combining the indoor and outdoor as one module, it's also connected by only water piping eliminating the need for refrigerant piping. Furthermore, hydronic components like the plate heat exchanger, expansion tank, water pump, flow sensor, pressure sensor, air vent valves, and safety valve are conveniently situated inside the unit. The R32 Monobloc S provides excellent heating performance, especially at low ambient temperature, while producing lower carbon emissions with R32.



Line-up	Capacity (kW)	4.0	5.5	6.0	7.0	9.0	12.0	14.0	16.0
R32 Monobloc S	1 Ø 230 V		●		●	●	●	●	●
	3 Ø 400 V					●	●	●	●



Therma V R32 Hydrosplit IWT

The LG Therma V Hydrosplit series separates the indoor unit (IDU) and outdoor unit (ODU), connecting them via water pipes. The unit's heat exchanger is located within the ODU, reducing the risk of indoor refrigerant leakage. Therma V R32 Hydrosplit IWT combines an indoor unit, a water tank and complex piping into a single, space-saving solution that is able to provide space heating, cooling and DHW supply. Relatively compact and lightweight, the innovative all-in-one is easy to install and operate, and boasts the outstanding reliability and efficiency. Since there is no need to install a separate domestic hot water tank for hot water supply, space is not wasted, and the concept with all-in-one enables quick installation.

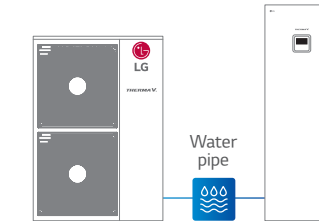

Line-up	Capacity (kW)	4.0	5.5	6.0	7.0	9.0	12.0	14.0	16.0
R32 Hydrosplit IWT	1 Ø 230 V						●	●	●
	3 Ø 400 V						●	●	●

* The power supply is shown based on the outdoor unit.



Therma V R32 Hydrosplit Hydro Box

The LG Therma V Hydrosplit series separates the indoor unit (IDU) and outdoor unit (ODU), connecting them via water pipes. The unit's heat exchanger is located within the ODU, reducing the risk of indoor refrigerant leakage. Therma V R32 Hydrosplit Hydro Box is a solution providing space heating, cooling and DHW supply with high installation flexibility thanks to the characteristic of being a wall mounted type. Since the indoor unit is installed on the wall rather than on the floor, space is not wasted, and the light weight enables quick installation. Also, it has good maintainability because the indoor unit is located indoors, for example in a machine room.

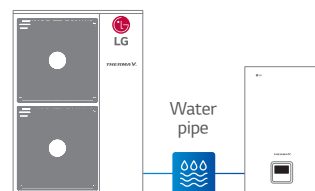

Line-up	Capacity (kW)	4.0	5.5	6.0	7.0	9.0	12.0	14.0	16.0
R32 Hydrosplit Hydro Box	1 Ø 230 V						●	●	●
	3 Ø 400 V						●	●	●

* The power supply is shown based on the outdoor unit.



LINE-UP INTRODUCTION



Therma V R32 Split Hydro Box

The LG Therma V R32 Split Hydro Box is a hydro box type system consisting of an indoor hydro box unit and an outdoor unit. The two units are connected by refrigerant piping only, thus hydronic components such as plate heat exchanger, expansion tank and water pump are located within the indoor unit. Due to the split nature, freezing will not compromise this unit regardless of outdoor ambient temperatures. The outdoor unit is on offer in 4/6 kW and 5/7/9 kW capacity range. R32 Split 4/6 kW model is suitable for new build houses that are well insulated and require a small heating load, while R32 Split 5/7/9 kW model is adapted for both new build and renovation projects.

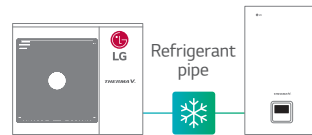

Line-up	Capacity (kW)	4.0	5.5	6.0	7.0	9.0	12.0	14.0	16.0
R32 Split Hydro Box	1 Ø 230 V	●	●	●	●	●			
	3 Ø 400 V								

* The power supply is shown based on the outdoor unit.



Therma V R32 Split IWT

The LG Therma V R32 Split IWT is a domestic hot water supply, space heating and cooling solution that conveniently combines an indoor hot water tank with a separate outdoor unit. Therma V R32 Split IWT is the perfect space-saving solution for residential applications because hydronic components like the Domestic Hot Water (DHW) and buffer tanks, which are typically installed separately, are fully integrated. Also, freezing will not compromise this unit regardless of outdoor ambient temperatures due to the split nature. The outdoor unit is on offer in 4/6 kW and 5/7/9 kW capacity range. R32 Split 4/6 kW model is suitable for new build houses that are well insulated and require a small heating load, while R32 Split 5/7/9 kW model is adapted for both new build and renovation projects.

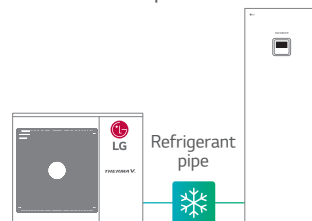

Line-up	Capacity (kW)	4.0	5.5	6.0	7.0	9.0	12.0	14.0	16.0
R32 Split IWT	1 Ø 230 V	●	●	●	●	●			
	3 Ø 400 V								

* The power supply is shown based on the outdoor unit.



Therma V R410A Split Hydro Box

The LG Therma V R410A Split Hydro Box is a hydro box type system consisting of an indoor hydro box unit and an outdoor unit. The two units are connected by refrigerant piping only, thus hydronic components such as the plate heat exchanger, expansion tank and water pump are located within the indoor unit. Due to the split nature, freezing will not compromise this unit regardless of outdoor ambient temperatures.

LG's Therma V R410A Split Hydro Box is designed for the benefit of users and installers who want to apply a heating solution to a large capacity building or applications subject to colder climate conditions. It has a maximized energy efficiency of A++ in the mid-temperature ranges, which results in reduced operating costs.

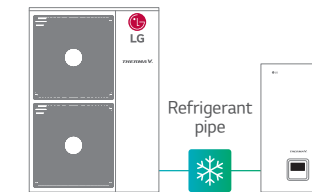

Line-up	Capacity (kW)	4.0	5.5	6.0	7.0	9.0	12.0	14.0	16.0
R410A Split Hydro Box	1 Ø 230 V						●	●	●
	3 Ø 400 V						●	●	●

* The power supply is shown based on the outdoor unit.



Therma V High Temperature

The LG Therma V High Temperature is a split type that consists of a floor standing indoor unit and an outdoor unit. Thanks to cascade (2 stage) compression technology, it can supply high leaving water temperature up to 80°C with high energy efficiency.

Since Therma V High Temperature is able to produce and supply the high temperature water without electric heater, it is suitable for houses which have poor insulation, older features or have to meet sanitary water regulations, which requires a higher water temperature.

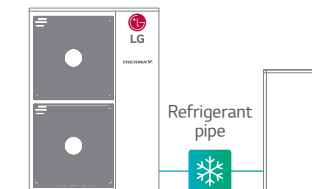

Line-up	Capacity (kW)	4.0	5.5	6.0	7.0	9.0	12.0	14.0	16.0
High Temperature	1 Ø 230 V								●
	3 Ø 400 V								

* The power supply is shown based on the outdoor unit.

LINE-UP INTRODUCTION



What is a Heat Pump Water Heater?

With an increasing emphasis on eco-conscious energy solutions, the LG Heat Pump Water Heater obtains 75% of its energy from outside air. This renewable energy source produces domestic hot water using two heat exchangers, a condenser and an evaporator.

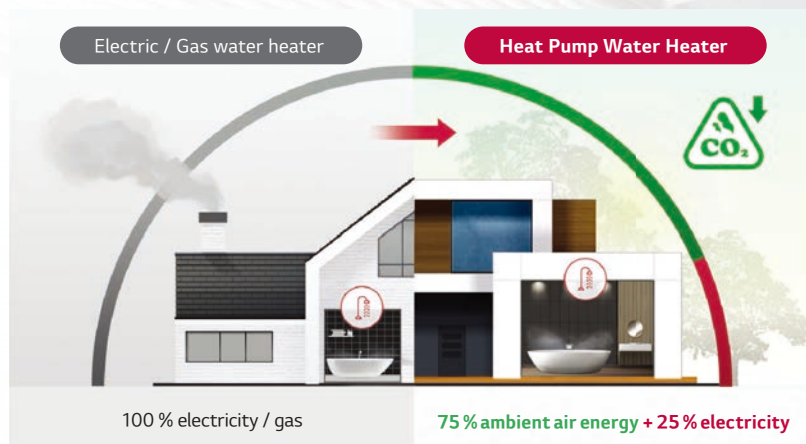

LG inverter technology

LG inverter technology can be found in many of LG's renowned devices, from refrigerators and washing machines to our air conditioner line-up. This technology allows the inverter compressor to achieve superior energy efficiency, cooling performance and comfort compared to compressors with on-off capabilities which is rare for monobloc heat pump water heaters.

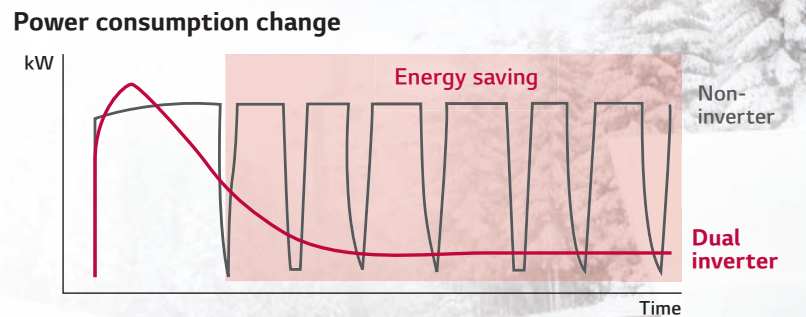

Line-up	Power supply	200 L	270 L
Heat Pump Water Heater	1 Ø 230 V	●	●
	3 Ø 400 V		

DUAL Inverter Compressor

- The top class efficiency
- Hot water performance ↑
- Low noise operation
- Various operation mode

Smart control

- Wi-Fi embedded
- Smart diagnosis
- Easy check & monitoring

LG design identity

- Premium interior design

Hygiene & durable tank

- Anti-legionella
- Impressed current titanium anode
- 10 year warranty

Flexible Installation Locations



Laundry room



Storage room



Bathroom



Bathroom



Garage



Garage

※ Actual product appearance may differ from the above simulated scene.

PRE-SALES/ENGINEERING TOOLS

Pre-sales/Engineering Tools

LG provides a variety of software to support Therma V for all customers including designers, installers, and end users.

1. LG Therma V Selector

The LG Therma V Selector is a mobile application for designers, installers and end users, which provides various real-life simulations. An energy simulation can quickly indicate energy consumption and cost as well as CO₂ emission values that can be vastly reduced from conventional heating systems using minimal input values.

With both model selection and energy simulation tools, quick and accurate selection is made possible with detailed input values such as desired system configuration, required heating and Domestic Hot Water (DHW) load, which will calculate payback, result in a faster energy simulation and generate cost comparisons. Sound level can also be calculated through simulations based on the installation environment.

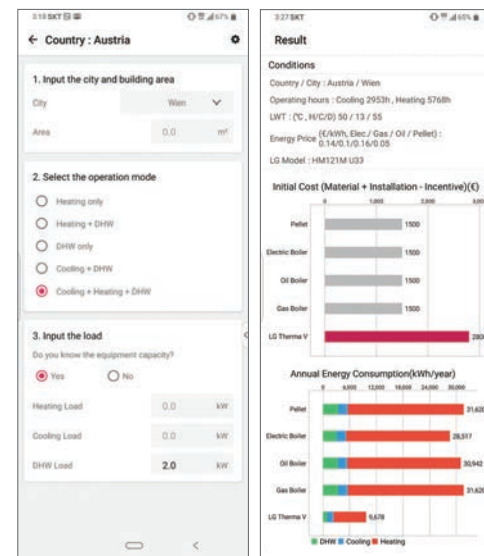

2. LATS Therma V

LATS Therma V is a PC-based model selection program of LG Therma V products, enabling an accurate and quick selection of the most suitable model in each end-user environment.

In addition to model selection, faster energy simulation and cost comparison to other systems are possible. Furthermore, customer is easily able to simulate payback compared to a conventional system such as a gas boiler, electric boiler by using LATS Therma V.

* LATS Therma V is available on the LG partner portal.

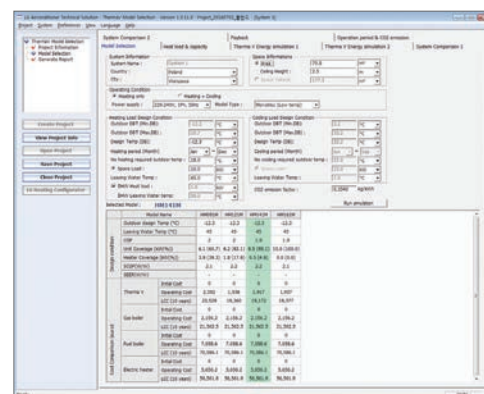

3. LGMV

LGMV is a useful engineering tool that monitors Therma V's real-time refrigerant and water cycle. It assists installers with effective and efficient start-up and commissioning after the Therma V installation. LGMV enables service/field engineers to detect the errors and troubleshooting for fast and reliable problem solving.

* LGMV is available on the LG partner portal.

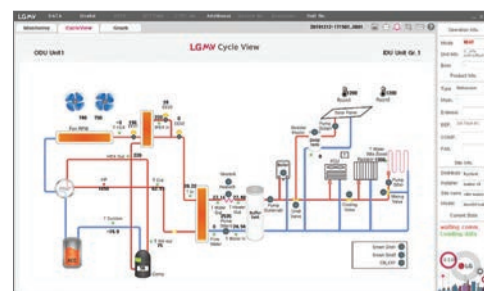

Therma V Selector

How to install?

Search "LG Energy Payback" in Google Play Store or Apple App Store.

Android



iOS



Simulation mode

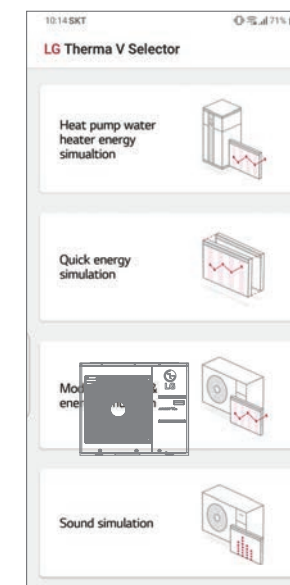

- ➔ 'Heat pump water heater energy simulation' is to provide energy simulation of a heat pump water heater compared to an electric heater based on climate condition. (colder, average, warmer)
- ➔ 'Quick energy simulation' is a quick & easy mode. Users can see the annual energy consumption, cost, and CO₂ emission with several inputs, which is similar to the LG Therma V website version.
- ➔ 'Model selection & energy simulation' is to provide more information about the model, energy simulation and payback simulation. Users can select or input more information about the site or design condition, then can see the suitable model, annual energy consumption, cost, CO₂ emission, and payback result.
- ➔ 'Sound simulation' shows the calculated sound result.



PRE-SALES/ENGINEERING TOOLS

Therma V Selector

Model selection & energy simulation

Before choosing an Air-to-Water Heat Pump, many customers wonder how much energy costs can be saved compared to conventional heating systems, and how to select a product with the right capacity for the home. The LG Therma V selector allows you to calculate annual energy costs and payback periods as well as model selection through sophisticated simulations through simple input values.

- City selection
- Building area input
- Operation mode selection
- Load input
- Operation period selection
- Model type selection
- Design condition input
- System selection to be compared

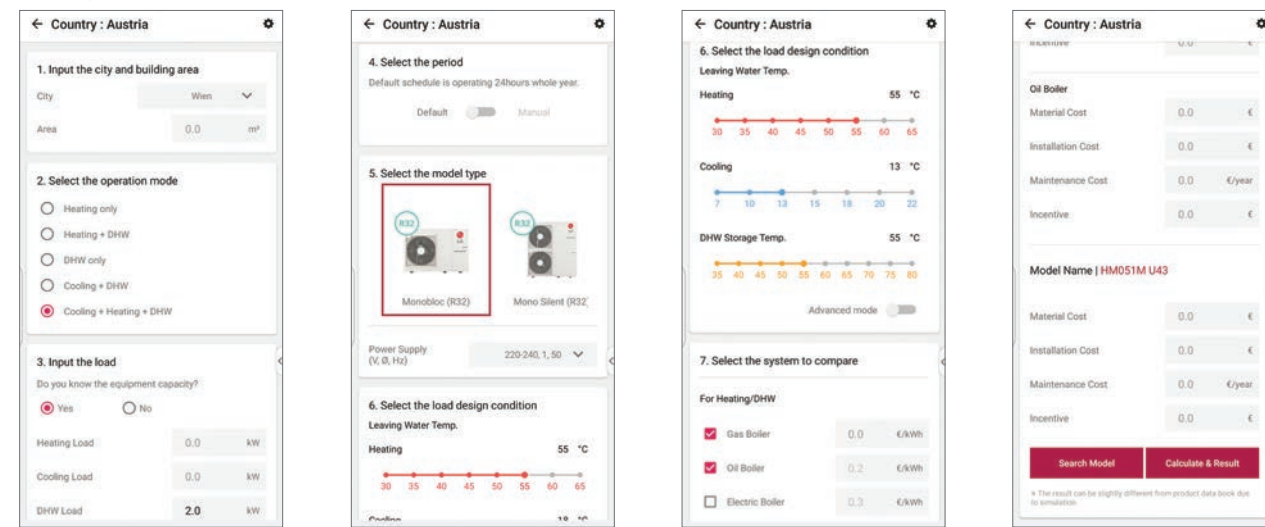

Sound simulation

Consumers are also wondering how much sound level will be after installing the Air-to-Water Heat Pump product. Using the sound simulation function of Therma V selector, you can predict the expected sound pressure values in the daytime and nighttime according to the installation distance and conditions.

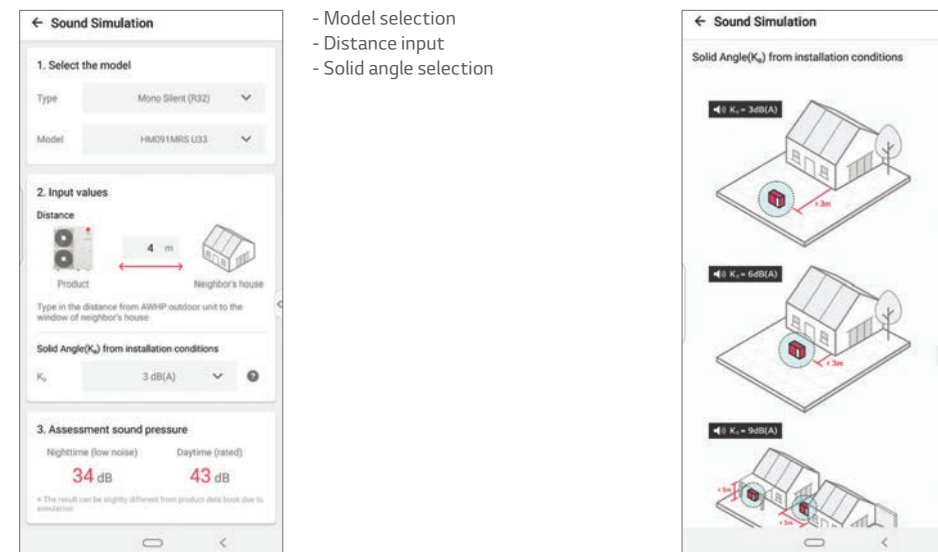

- Model selection
- Distance input
- Solid angle selection
- Reference for solid angle selection

Result & report

After the simulation, analysis results including initial investment cost, annual energy consumption, and payback period can be checked in the form of various graphs. Moreover, this report is provided in PDF format and can be shared by e-mail and messenger.

Result

- Simulation conditions summary
- Initial cost
- Annual energy consumption

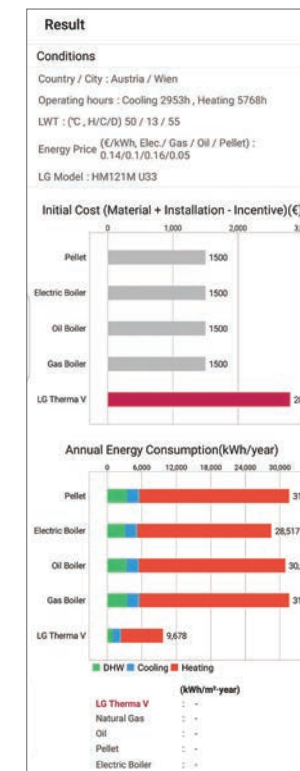

- Annual cost
- Annual CO₂ emission
- 10-year life cycle cost analysis

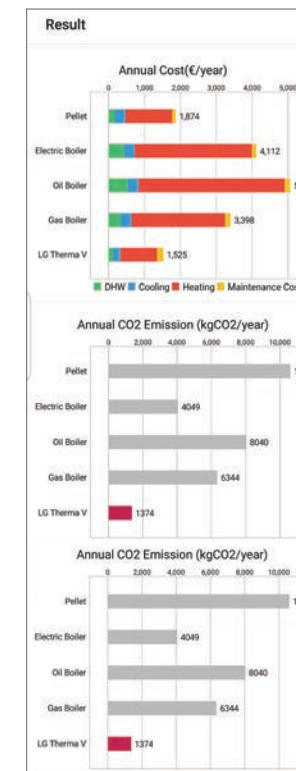

- 10-year life cycle cost analysis
- Payback year
- 15-year life cycle cost analysis graph

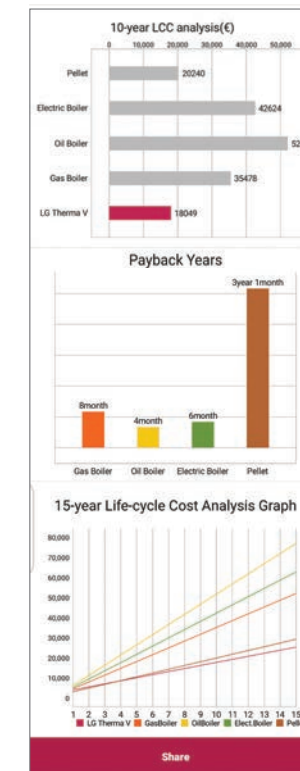

Report

- Cover page



- Site information & design condition
- Product specification

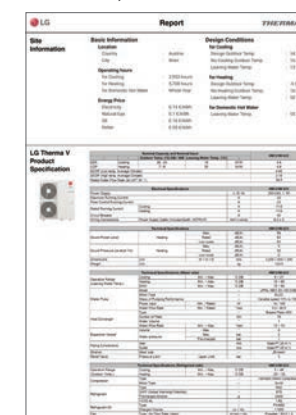

- Annual energy consumption
- Life cycle cost



- Drawings

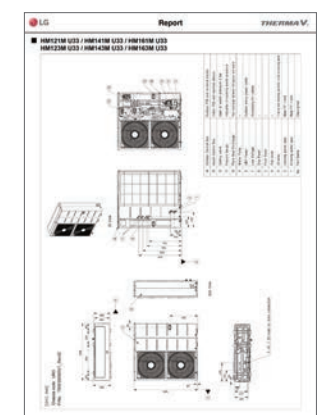

ThinQ SEAMLESS CONNECTIVITY

Smart Control, Smarter Life

LG ThinQ, a smart phone app, allows users to monitor and manage compatible LG products remotely, which means they can set the temperature and regulate the use of their Therma V anytime and anywhere. In most EU countries, LG ThinQ technology also works with Google Assistant, letting users control their Therma V with voice commands.



Mandatory accessory: PWFMD200 (LG Wi-Fi Modem) / PWYREW000 (10 m extension connect cable in between Therma V indoor and LG Wi-Fi Modem) could be required depending on installation conditions.
 * Search "LG ThinQ" on Google market or App store, then download the app.
 * Google assistant voice control may be restricted in use and language in some countries.
 * Google and Google Home are trademarks of Google LLC.
 * Voice-enabled smart speaker device is not included.

How to install the LG ThinQ app

Search and install for the LG ThinQ application from the Google Play or Apple App Store on a smart phone.

For Android users



For iOS users



How to connect Therma V to the LG ThinQ app

In the video below, see how to install Wi-Fi modem and connect Therma V and ThinQ.

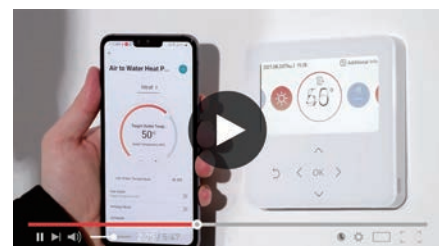

Connect and control from anywhere, anytime

The LG ThinQ allows you to easily control your heating system in a way you never could before. Start to experience smart control of Therma V with just the tap of a button. Even when you are outside, you can operate the Therma V remotely.



Simple control with voice assistant

Tell your Therma V exactly what you need it. Say, "Turn on/off the Therma V" and the AI speaker will listen and turn on/off the Therma V.

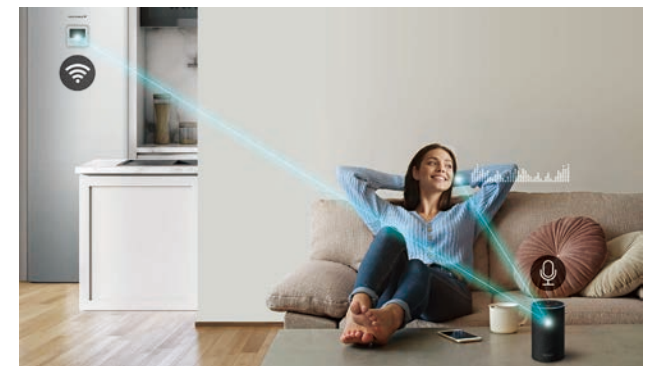

Efficient energy monitoring

The LG ThinQ app continuously monitors Therma V. Whether it's everyday maintenance or something else, the app allows you to easily monitor energy usage.

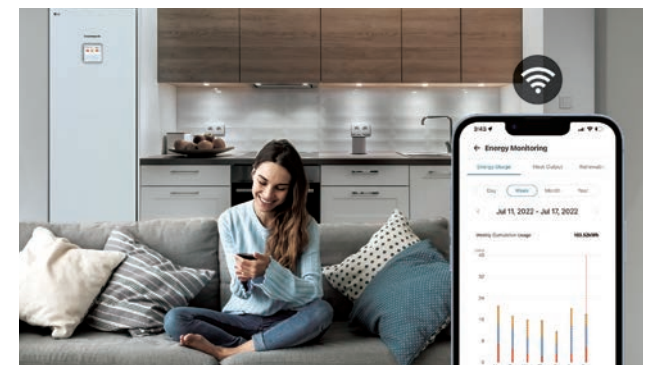

ThinQ mobile app

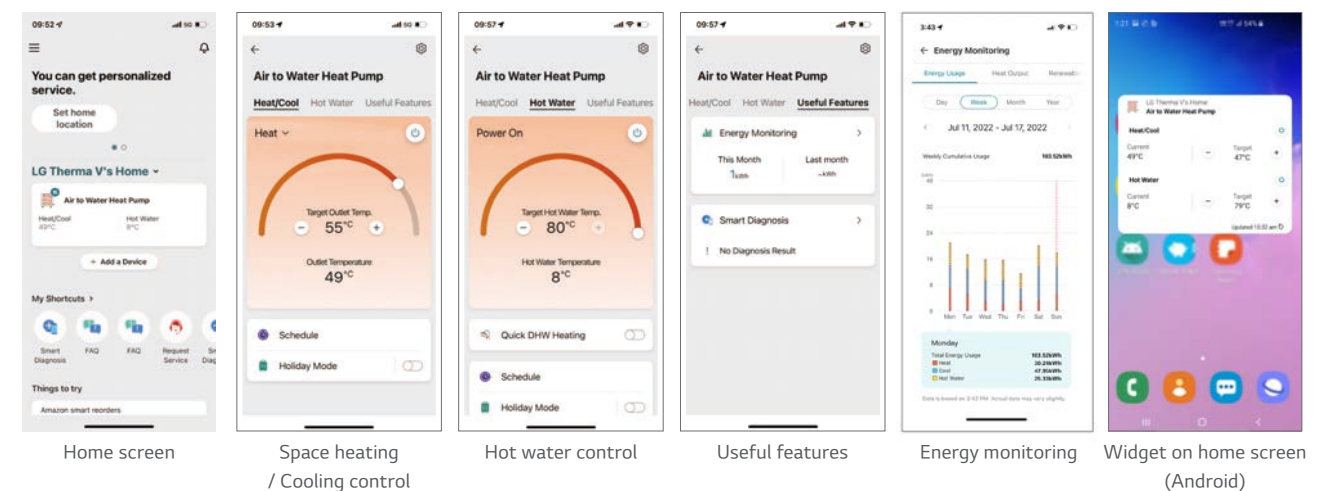

This image is intended to help you understand, and there may be some differences in actual use.
 * Control via widgets is only possible with the Android app.

LG BECON CLOUD SERVICE

for **THERMA V™**



What is LG BECON Cloud Service?

LG BECON cloud service is a cloud-based service that remotely monitors a customer's heating system via PC, tablet or mobile anytime, anywhere. The operation status of the heat pump can be monitored at a glance as well as the past operation history. In the event of an issue, the cause can be identified in advance and the repair can be completed during a one-time visit. For more details and service contract, please contact your LG regional service contact.

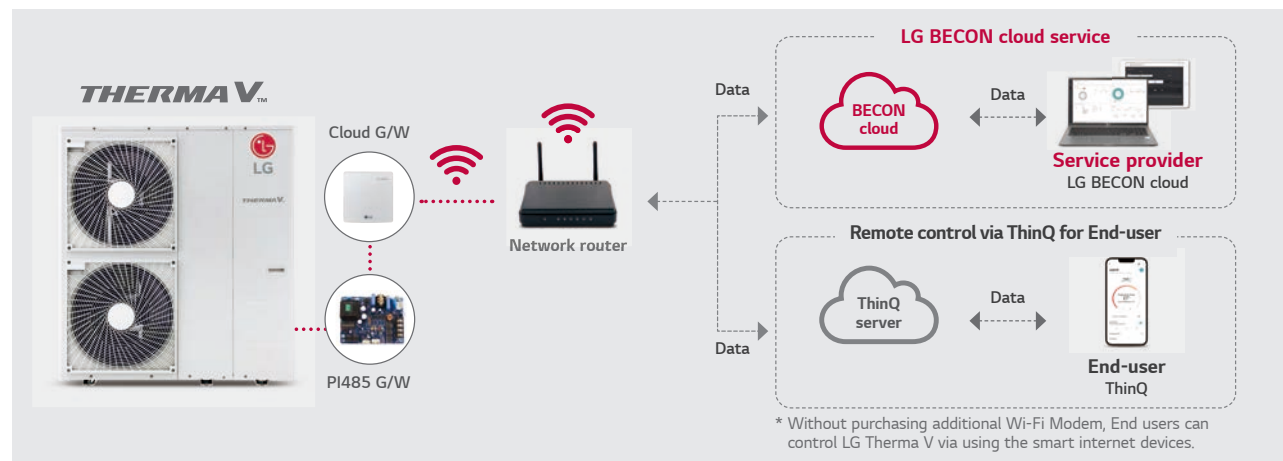

Target Customer and Benefits

Service partners / Installers

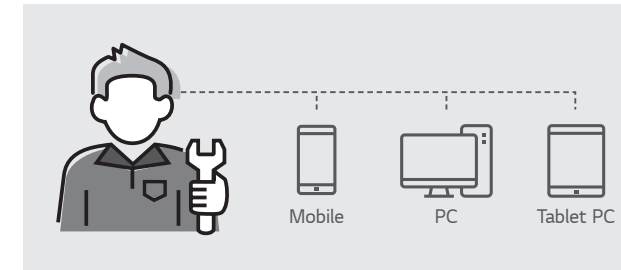

✓ Save time and cost

- One time visit with right parts
- No need pre-visit for diagnosis

✓ Quality of service

- Better service to end users with accurate diagnosis and fast repair

✓ Increased business opportunity

- Combine product + service offer
- Make more installation / repairs

End-users

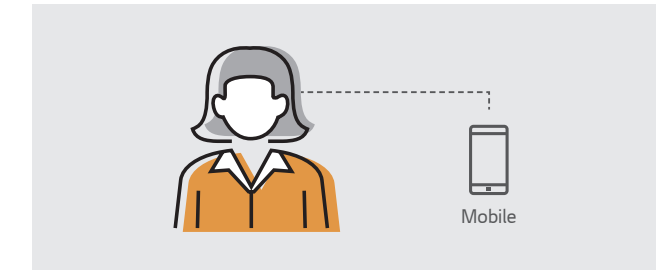

✓ Enjoy peace of mind

- Be serviced at once or faster
- Be confident that immediate and quality of service will be provided in case of an error

✓ Less constraints

- No need to be at home for first diagnosis
- Monitor the operation status and control the system remotely

Key Features



Management at a glance

- Monitoring status of customers
- Interactive map view or list view



Energy monitoring

- Providing warning if energy usage is excessively high
- Display estimated power consumption by self-calculation



Monitoring with visualized schematic

- Examining the operating state of the heat pump
- Schematic view or table view
- Cycle monitoring, sensor and actuator monitoring
- Current status and historical data



Operation and error history

- Providing operation data and error history to quickly identify the issue
- Operation history, error history, setting history, etc



Remote control via cloud

- Preventing unnecessary site visit caused by simple operation mistake
- Operation mode (heating / cooling / DHW), target temperature
- Emergency operation, low noise operation, quick DHW operation



Error notification by e-mail

- Providing an e-mail notification automatically when an error occurs
- Possible to identify immediately and take a fast action

LG BECON CLOUD SERVICE

for THERMA V™

Why LG BECON Cloud Service?

Quick service response time

Saving time and cost thanks to remote diagnosis of operation cycle without access to product.

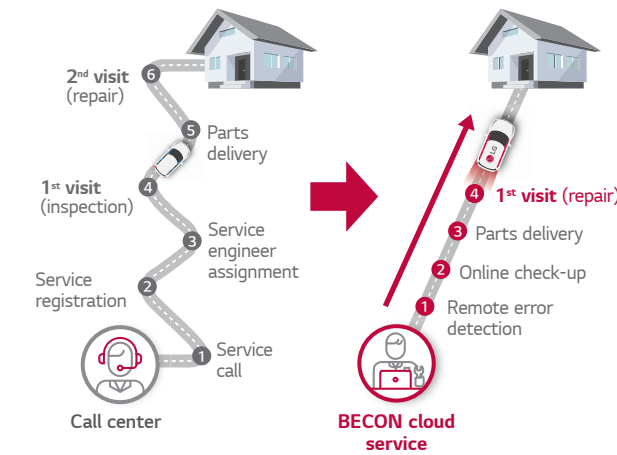

Accurate diagnosis

Accurate diagnosis for cause of failure can be done by utilizing the error code and cycle data when an actual failure occurs.

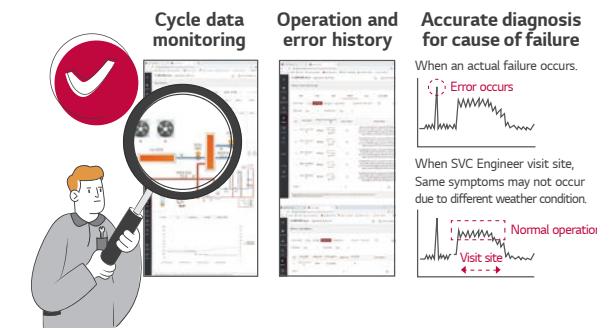

Remote device control

With single account, maintenance service provider (or installer) can control their customer's sites remotely. As a result, site visit is not needed for minor issues, such as adjusting temperature or mode.

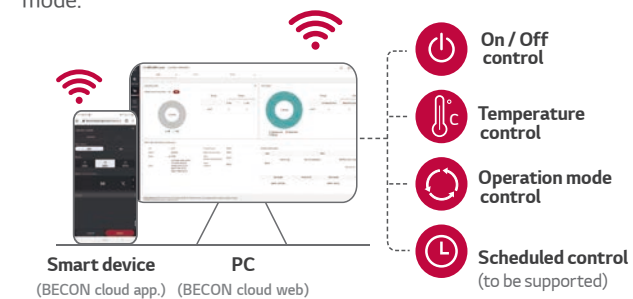

Energy monitoring

Power consumption based on self-calculation is recorded and displayed. Maintenance service provider (or installer) can provide warning if energy usage is excessively high.

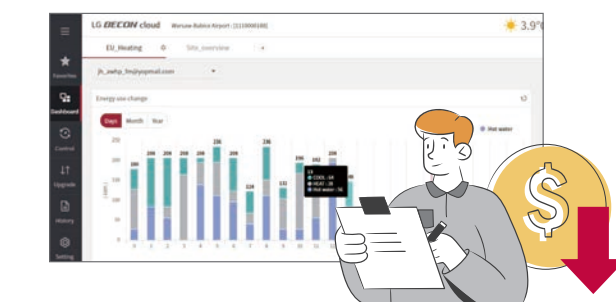

Error notification by e-mail

Providing an e-mail notification automatically when an error occurs, making it possible for maintenance service provider (or installer) to immediately identify and quickly react.

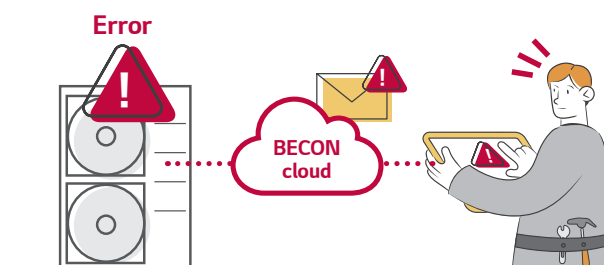

ThinQ for end-users

Without purchasing additional Wi-Fi Modem, end-users can control LG Therma V via using smart internet devices.

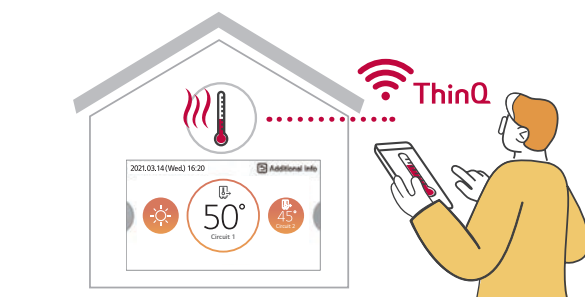

Requirements



Compatible Therma V ¹⁾	Required accessory	Network router
R32 Monobloc S R32 Split Hydro Box R32 Split IWT R32 Hydrosplit Hydro Box R410A Split Hydro Box	Cloud gateway (PWFMDB200) PI485 gateway (PP485A00T)	Wireless or wired LAN
LG BECON cloud service contract	Supported device / software	Supported language ²⁾
Authority (ID and PW) to use LG platform (LG BECON cloud service)	PC, Tablet, Mobile PC or Mobile web browser, Mobile app. (Android / iOS)	English, Spanish, Italian, German, Polish, Greek

1) Therma V lineups supporting this service will be gradually expanded. Please consult your regional sales manager.
2) More languages will be supported sequentially. The schedule for service availability may vary by country.

Interface Screen

Dashboard

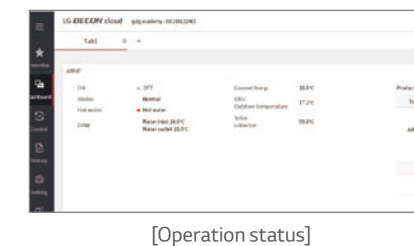
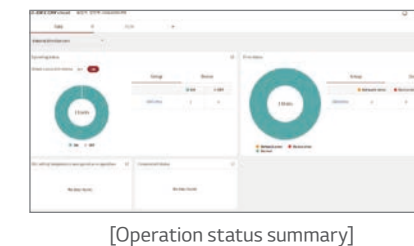

Site

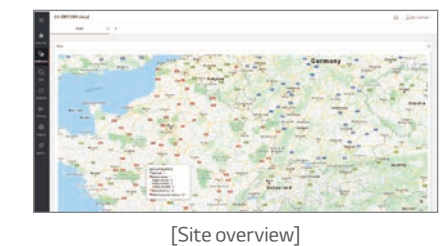

Control

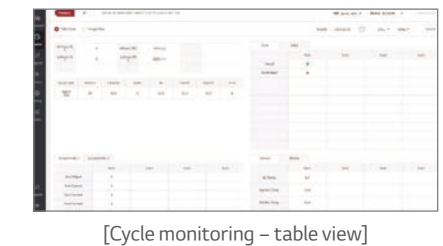
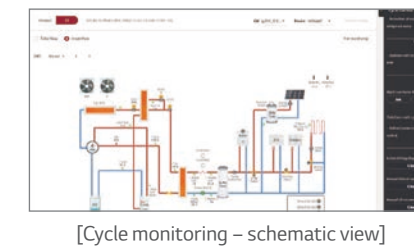

History

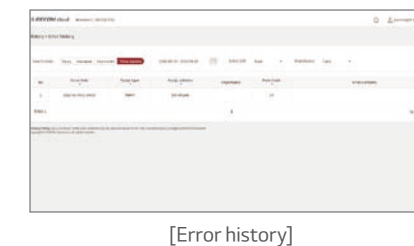

LG SMART HOME ENERGY PACKAGE



* Availability of LG Smart Home Energy Package may vary by region. Please consult your regional sales manager.

Power your home the smart way and save the energy bill

Your connected energy solution at a glance. The LG smart home energy package consists of LG's Energy Storage System (ESS) and the Air-to-Water Heat Pump (AWHP or ASHP), a system that's been expertly designed with compatibility in mind.

With LG, you are able to minimize the energy cost and one step closer to the ultimate smart home.

Conventional products

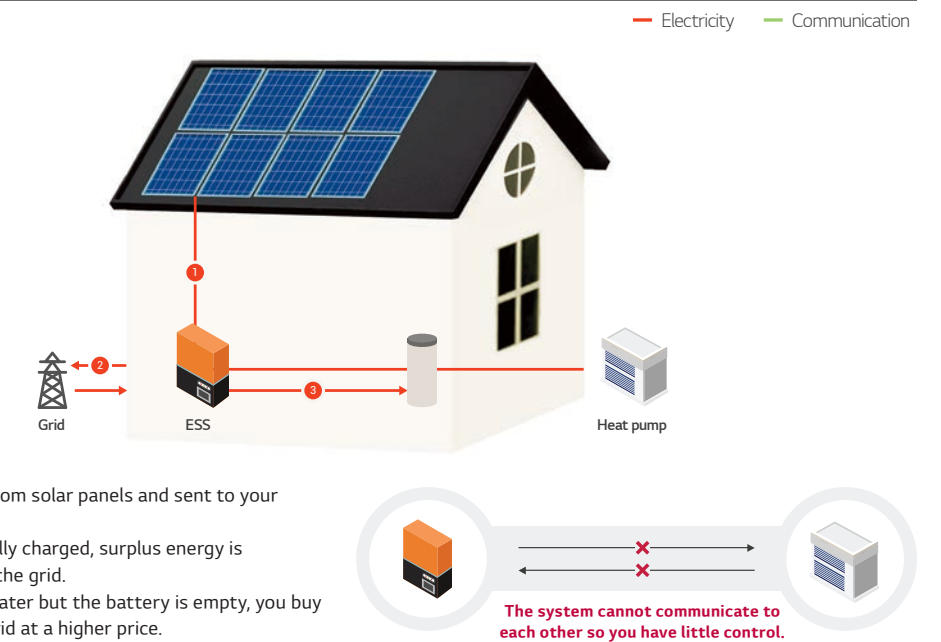

LG energy package

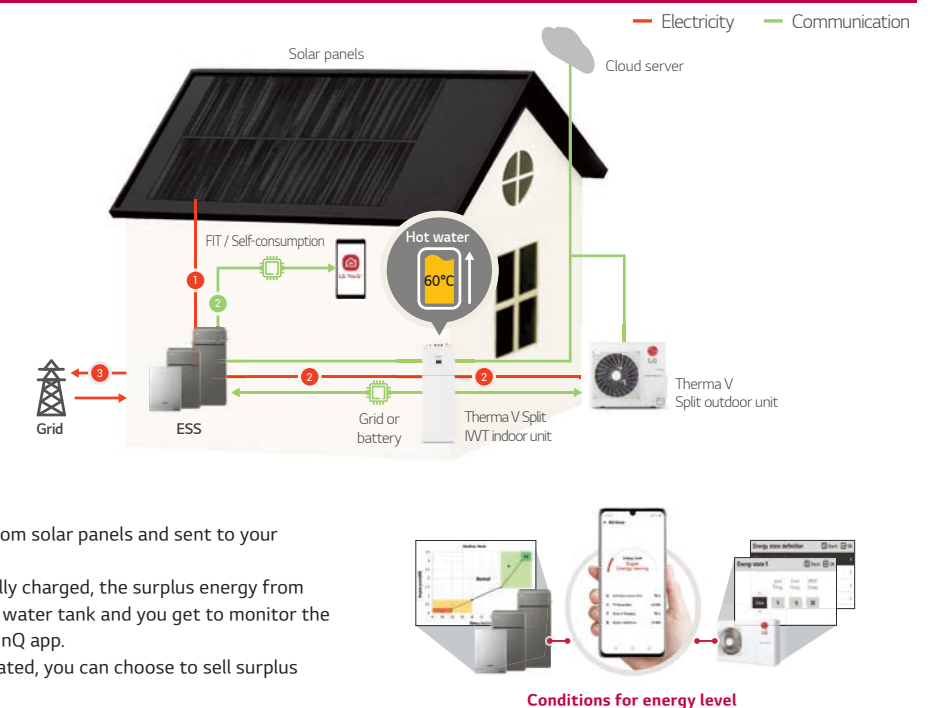

#Care For Where You Live



THERMA V™



THERMA VTM FEATURES



LG Therma V's unique features

LG Therma V has been designed for providing efficient space heating and domestic hot water heating with usage convenience to the customer. To achieve this ultimate goal, LG has developed and applied core technologies and functions for heating to the LG Therma V.

User convenience

LG Therma V is equipped with various user convenience functions, which guarantee enhanced comfort and control. The text-based user-friendly interface on the remote control allows for optimized user intuition and the unit's wide connectivity also provides for user control convenience.

Excellent performance & efficiency

LG Therma V provides world-class energy efficiency by adopting LG's revolutionary technology such as the R1 Compressor and the Black Fin heat exchanger. LG products have achieved a high heating performance even in extremely cold weather conditions and LG Therma V can bring customers peace of mind through product reliability.

Easy installation & maintenance

LG Therma V offers installation and design flexibility to professional installers. The LG heating configurator also allows professionals to save time during commissioning. During maintenance, the clip type connection allows fast and easy disassembly of the components.

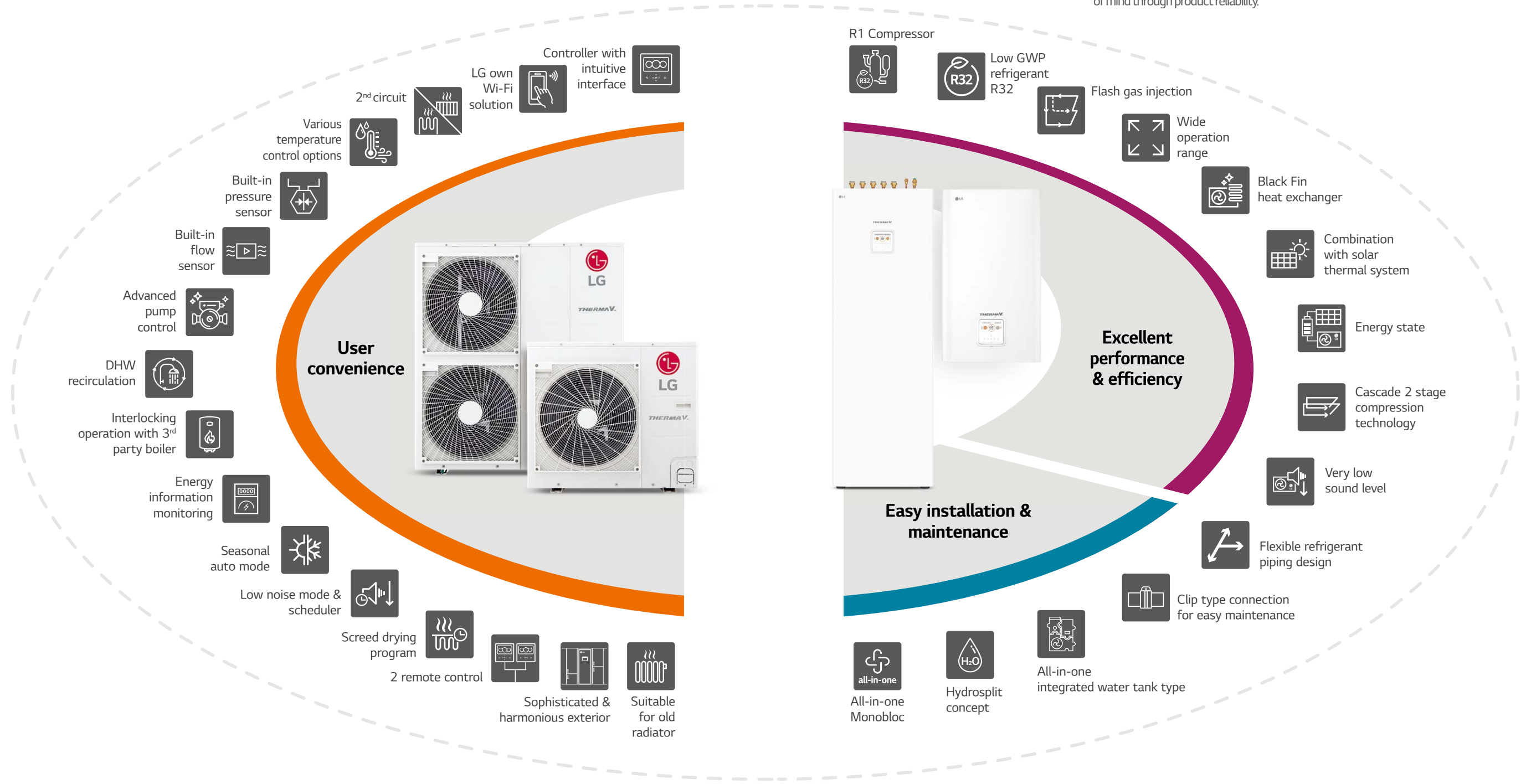

EXCELLENT PERFORMANCE & EFFICIENCY

Eco-Conscious With R32 Refrigerant

Background

Due to accelerated global warming and the destruction of the ozone layer, various international conventions and meetings are held to enhance restrictions to the use of refrigerant or enforce the use of eco-conscious refrigerant R32 which is internationally acclaimed as being eco-friendly. This low volume refrigerant is as efficient as any conventional refrigerant but boasts a 68 % reduced GWP (Global Warming Potential).



What is GWP?

Global Warming Potential is a measure that allows for an accurate comparison of the environmental impact of different gases. GWP measures how much energy the emissions of 1 ton of a gas will absorb over a given period of time, relative to the emissions of 1 ton of carbon dioxide (CO₂).

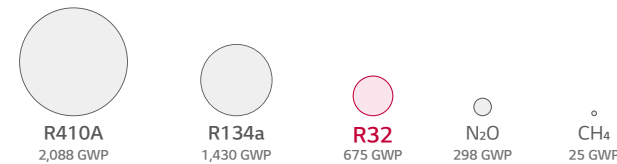

Global trend and EU regulation for F-gas

HFC* phase down 79 % by 2030

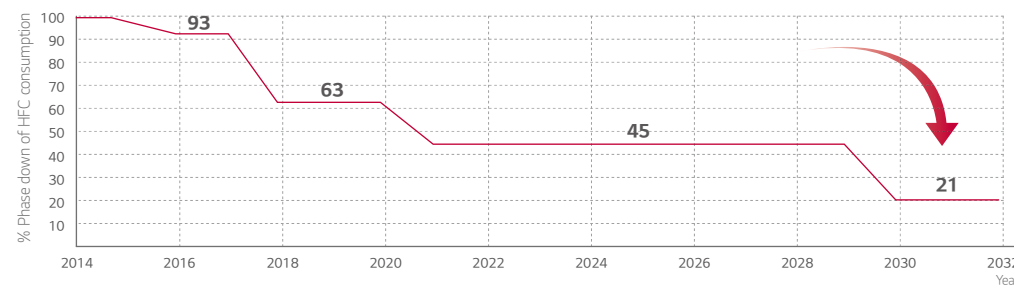

79 %
HFCs refrigerants should be reduced by at least 79 % by 2030 compared to 2013.

* Hydrofluorocarbon: one of the alternative freon gas that does not harm the Earth's ozone layer

Comparison & benefit

R32 efficiently works even in small volume compared to existing R410A refrigerant, which decreases the potential hazard of global warming. Furthermore, R32 refrigerant is easy to recycle thanks to its single composition.

Description	R32	R410A
Low Global Warming Potential (GWP)	675 ¹⁾	2088 ¹⁾
Lower amount of gas charge	Less	High
Higher achievable water temperature	Potentially high	Relatively low compared to R32
Higher system performance	R32 systems also use less refrigerant per kilowatt of capacity delivered.	
Simple refrigerant recyclability	Single component	Mixture R32 50 % / R125 50 %
High capacity	High refrigerant compression rates lead to high capacity as compared to existing refrigerant R22 and R410A.	

1) Source: global warming potential values (2007, AR4)

2) This ratio is general for helping understanding. It may differ depending on the each product.

RI Compressor™ LG's Revolutionary Technology

RI Compressor™ technology offers advanced efficiency, reliability and operational range due in part to the enhanced tilting motion of the scroll.

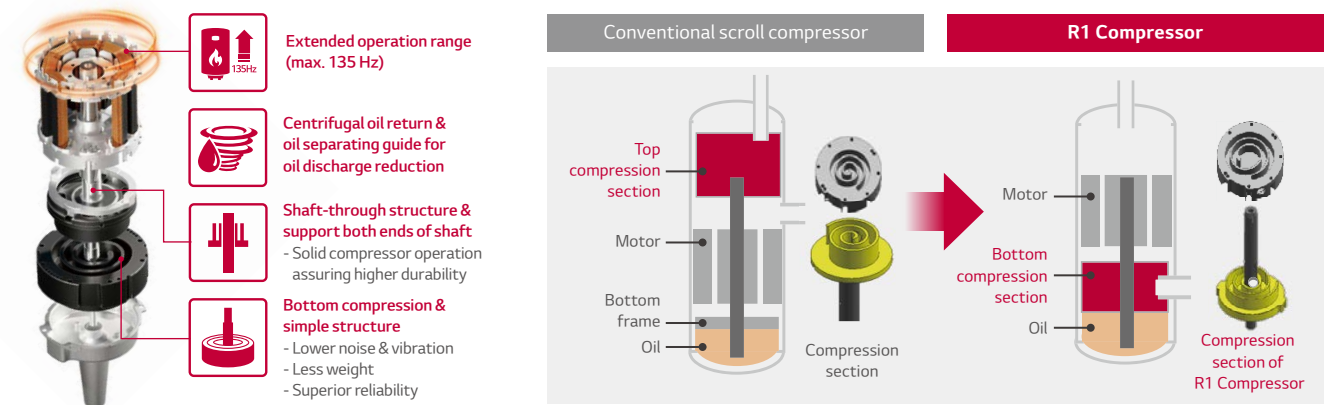

Black Fin Heat Exchanger

The Therma V line-up includes a heat exchanger enhanced by black coating with enhanced epoxy resin for strong protection. This improvement in durability prolongs the product's lifespan and lowers both the operational and maintenance costs.

Black Fin

Hydrophilic film (water flow)

The hydrophilic coating minimizes moisture build up on the fin.

Acryl + Epoxy + Melamine resin (corrosion resistant)

The black coating provides strong protection from corrosion.

Aluminum fin

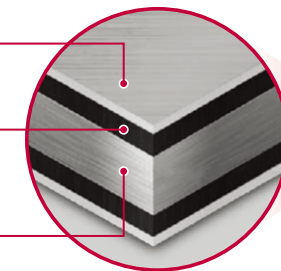

- Longer lifespan, lower operation costs
- Strengthened corrosion resistant coating

Energy States Interlock

LG Therma V provides an energy state interlock function enabling customers to use their own renewable energy as much as possible. It can shift set points depending on input signal from the Energy Storage System (ESS) or any other third-party device using Modbus or Digital 230 V inputs.

- 1) Energy is generated from panels and sent to your battery.
- 2) Once the battery is fully charged, the surplus energy from ESS will heat the water tank. The user gets to monitor the status with the LG ThinQ app.
- 3) Once the water is heated, the user can choose to sell surplus energy to the grid.

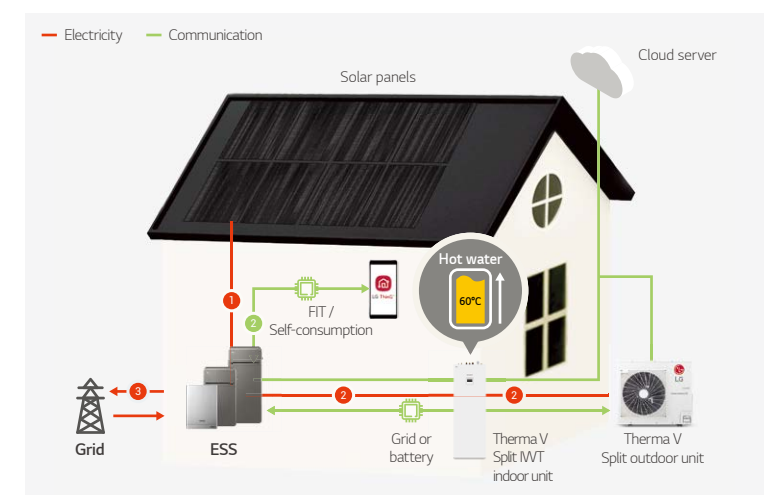

* The figure on the right shows the R32 Split IWT as an example. Therma V High Temperature model does not support this function.

EXCELLENT PERFORMANCE & EFFICIENCY

Combination With Solar Thermal System

By combining the solar system with Therma V, the efficiency of DHW heating operation can be maximized. During the day when there is a lot of sunlight, heated water by solar give some help heating the DHW tank.



* Therma V IWTs and High Temperature model don't support this function.

Flash Gas Injection

With the LG Therma V R32 series, flash gas injection technology is applied to control the discharge temperature of the compressor efficiently. As a result of this technology, the heating operation range is expanded and the heating performance at low ambient temperature is enhanced.

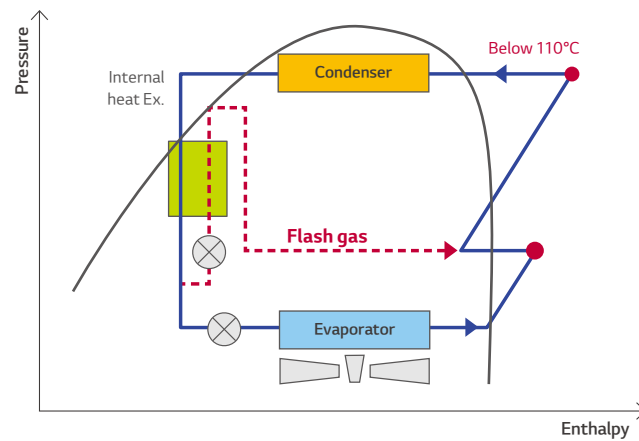

Direct Modbus Communication

Therma V can be connected and controlled by a 3rd party control system using Modbus protocol directly, without passing Modbus RTU gateway.



* The figure on the right shows the R32 Monobloc S as an example. Therma V High Temperature model does not support this function.

USER CONVENIENCE

ThinQ Seamless Connectivity

Users can control their Therma V via smart internet devices such as Android or iOS smartphones. Moreover, LG ThinQ works with Google assistant voice control in most EU countries, making it possible to control Therma V using a voice control function.



Mandatory accessory: PWFMD200 (LG Wi-Fi modem) / PWYREW000 (10 m extension connect cable in between Therma V indoor and LG Wi-Fi modem) could be required depending on installation conditions.

* Search "LG ThinQ" on Google market or App store, then download the app.
* Google assistant voice control may be restricted in use and language in some countries.

Energy Monitoring via Remote Controller and ThinQ

Estimated power consumption and thermal energy can be monitored on both the remote controller and LG ThinQ¹⁾ without connecting meter interface.

- Instant power consumption
- Power consumption by period (daily, weekly, monthly, yearly): categorized as heat, cool, and DHW
- Produced heat output by period (daily, weekly, monthly, yearly)²⁾
- Renewable energy by period (daily, weekly, monthly, yearly)^{2), 3)}

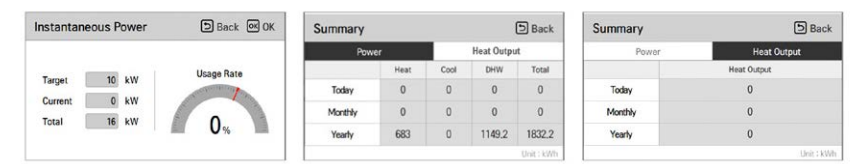

Remote control screen⁴⁾

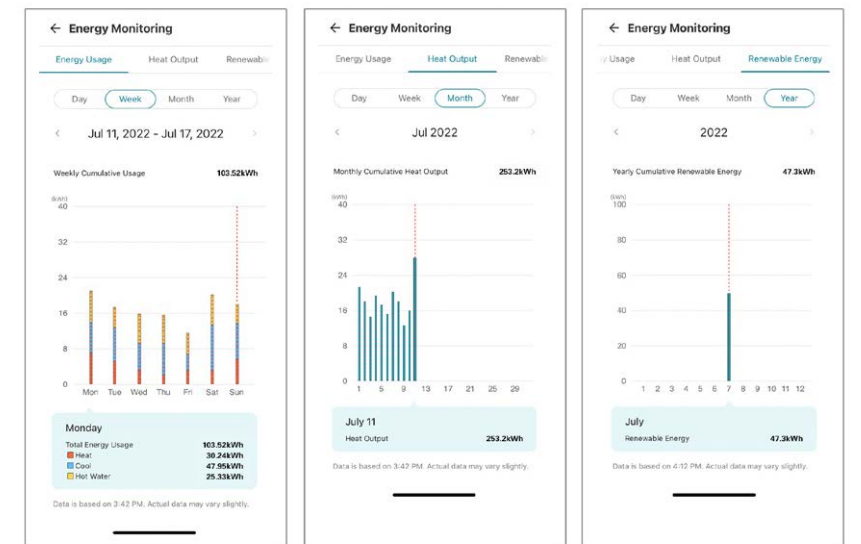

LG ThinQ app screen⁴⁾

- 1) To use LG ThinQ, LG Wi-Fi modem (PWFMD200) is required.
- 2) When using antifreeze, it will not be available.
- 3) This energy information is only available with LG ThinQ in Spain.
- 4) This image is intended to help you understand, and there may be some differences in actual use.

USER CONVENIENCE

Intuitive Control

Therma V is equipped with a new remote controller which supports various functions.

- Premium design (4.3 inch color LCD)
 - User friendly interface (simple graphic, icon & text)
 - Convenient functions (easy schedule setting & installer setting)
 - Energy monitoring without meter interface (estimated power consumption)
- * Instant power consumption and cumulative power consumption

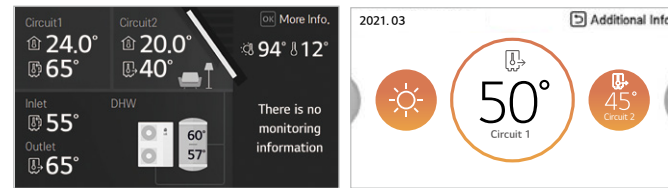

Seasonal Auto Mode

The operation mode and target temperature will be changed according to the outdoor temperature automatically. Moreover, this function can be conveniently set using visualized graphics.



* Therma V High Temperature model has slightly different function as it doesn't support the cooling operation.

Various Temperature Control Options

Various temperature control options are possible for the user's comfort and convenience, to include the newly added simultaneous control option (room and water temperature).

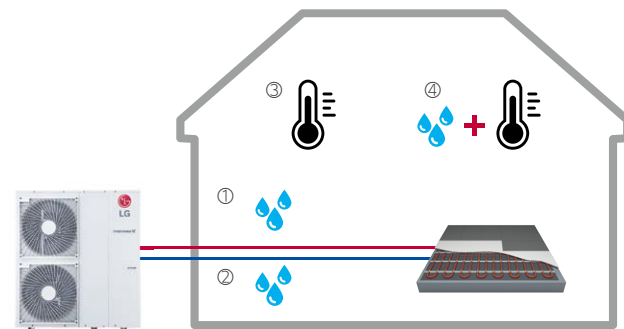

- Option 1: control based on leaving water temperature
- Option 2: control based on entering water temperature
- Option 3: control based on room air temperature
- Option 4: control based on room air and water temperature simultaneously

Advanced Pump Control Options

Various pump control options are available for the user's convenience. Now, water flow rate can be changed according to the heat load condition, therefore making it more energy efficient under low load conditions.

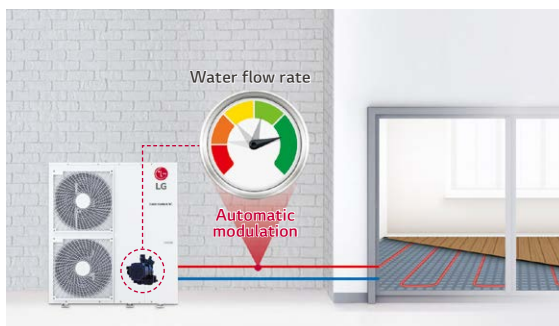

Options	Description	Water flow change as per load condition
Pump capacity	It operates with the capacity set for the water pump. (range 10 - 100%)	No
Fixed flow rate	Automatically controlled to maintain the set flow rate. (5, 7, 9 kW range: 8 - 26 LPM / 12, 14, 16 kW range: 17 - 46 LPM)	No
Fixed ΔT ¹⁾	Automatically controlled to maintain the set ΔT. (range 5 - 13 °C)	Yes
Optimal flow rate (default)	ΔT is changed as per target temp.	Yes

1) ΔT = temperature difference between inlet and outlet water temperature.
* Therma V High Temperature model does not support this function.

2nd Circuit

It is possible to control two separate individual zones (circuit 1 & circuit 2) with different temperature using mixing valve kit. It provides adequate heating and comfort to the end-user.

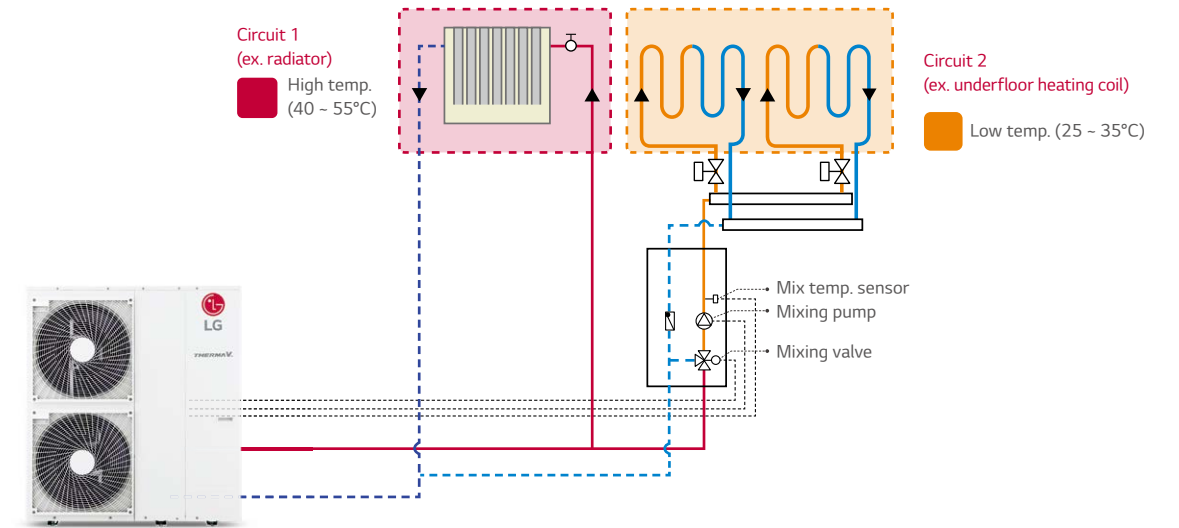

* Mixing valve kit or mixing pump group should be purchased and installed separately. Therma V High Temperature model does not support this function.

Interlocking Operation with 3rd Party Boiler

A 3rd party boiler such as oil, gas or electric boiler can be activated automatically or manually by the remote controller as an auxiliary equipment of Therma V.

Control mode: auto / manual

- Auto control mode: in order to protect Therma V, a 3rd party boiler is automatically activated when outdoor temperature is lower than certain temperature instead of Therma V. (default: -7°C, range: -25 - 15°C)
- Manual control mode: user can manually operate a 3rd party boiler via Standard III remote controller as needed.

Auto control mode

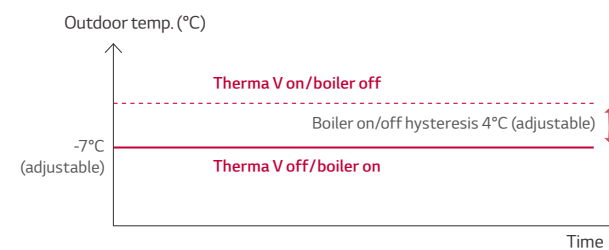

* Therma V High Temperature model does not support this function.

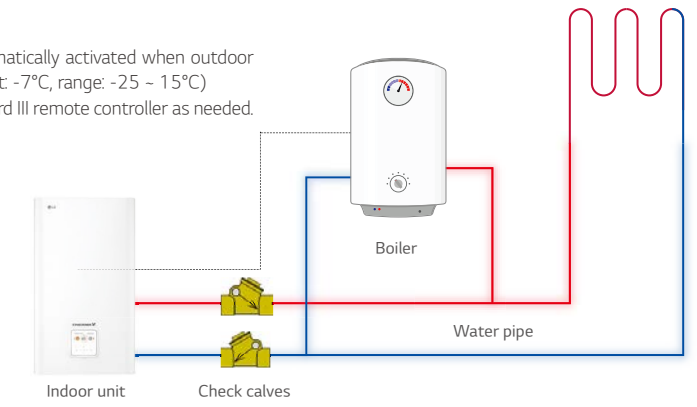

* 3rd party boiler should have a water pump integrated with it.

Water Circuit Monitoring

Not only water circuit temperature but also flow rate and pressure can be monitored via a remote controller. This information is not only useful for the installer during installation, but also helps to periodically clean the strainer during maintenance.

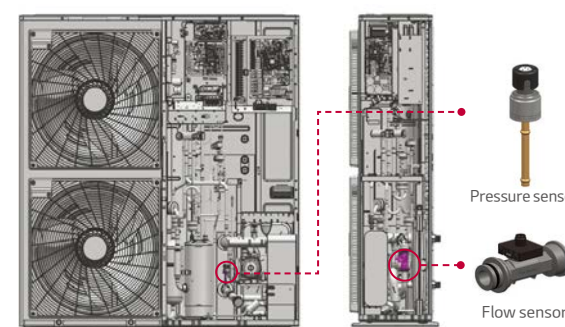

* Therma V High Temperature model does not support this function.

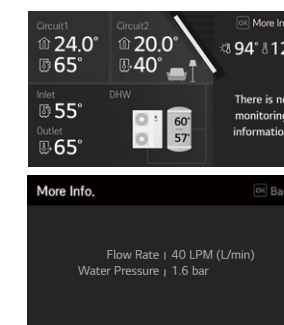

- ### Available information on the screen
- The room temperature
 - The water inlet / outlet temperature
 - The water pump operation
 - The water flow rate
 - The water pressure
 - The solar heat temperature
 - The outdoor temperature

USER CONVENIENCE

DHW Recirculation Pump Control

Therma V can be connected to the DHW recirculation pump, which can then be managed via the scheduling function. When a user opens the faucet, hot water is immediately accessible thanks to the DHW recirculating function. This feature also has the added advantage of preventing Legionella growth in the hot water pipe.



* Therma V High Temperature model does not support this function.

Low Noise Mode & Scheduler

Low noise mode operation can be activated by remote controller and set on a weekly on/off schedule to reduce the unit's noise level.

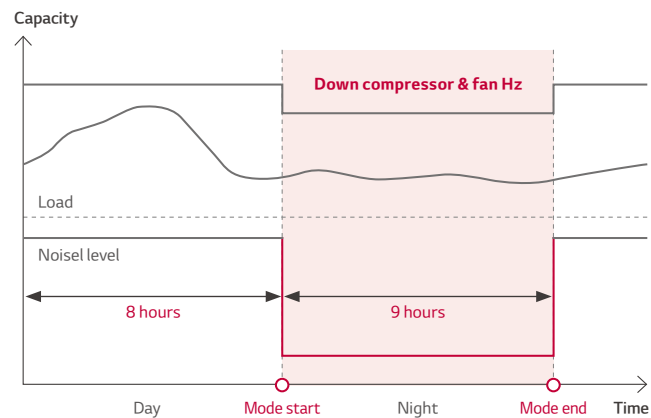

2 Remote Control

Enhanced convenience with an additional control installed in another residential area.

System diagram

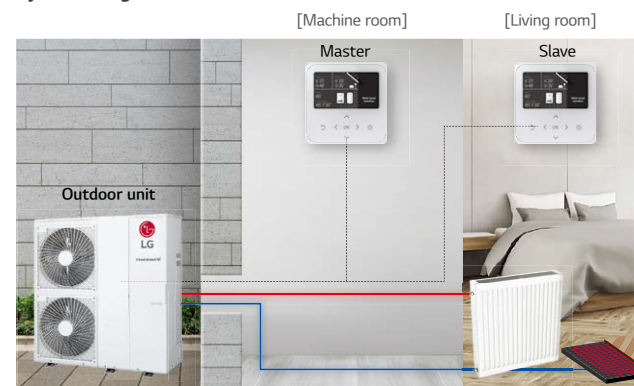

* Master is for the installation setting.
* Slave is for user setting.

Standard III controller interface

• Therma V is operating based on the room where a slave controller is installed.

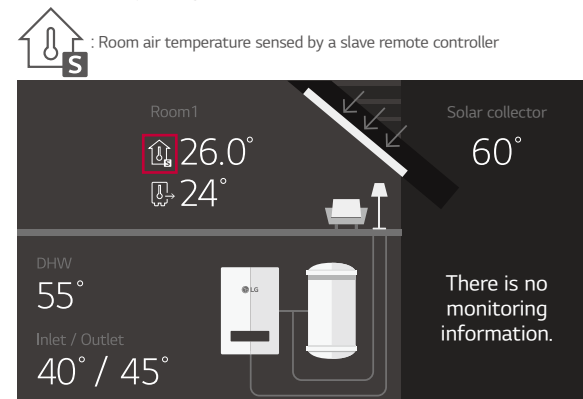

EASY INSTALLATION & MAINTENANCE

Monobloc Concept

R32 Monobloc S is an all-in-one concept, with its reduced weight allowing quicker and easier installations.

- Additional hydronic components are included in the package
- Easier and quicker installation without refrigerant piping work
- The best solution when space heating only is needed or in case of a 3rd party DHW tank.

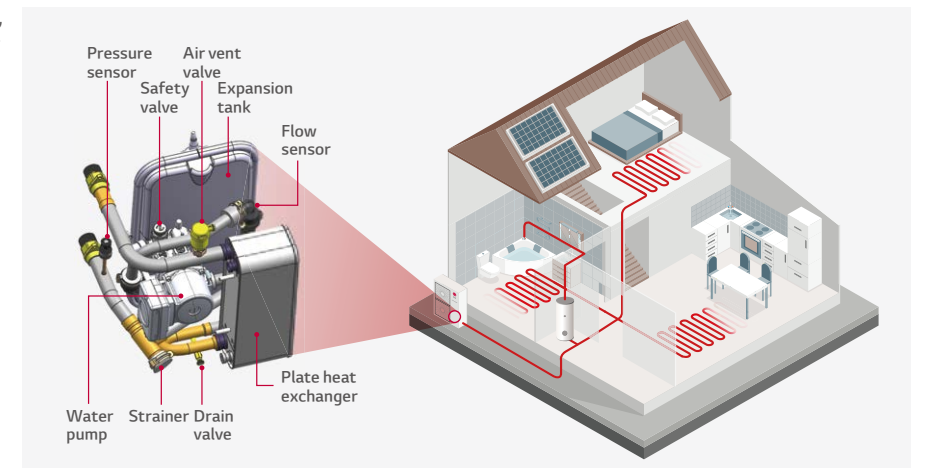

Hydrosplit Concept

The Therma V R32 Hydrosplit series connects an IDU and ODU by water pipes due to the heat exchanger's location in the outdoor unit, thus reducing the risk of indoor refrigerant leakage.



All-in-One Solution: Integrated Water Tank Type

Therma V's IWT indoor units are the perfect space-saving solution for residential application thanks to its fully integrated hot water tank. Unlike in the case of typical separate installation, in this all-in-one solution hydronic components and Domestic Hot Water (DHW) are pre-wired, which requires reduced installation time and saves valuable living space. Therma V's IWT indoor units are easy to set up and operate while it demonstrates outstanding reliability and efficiency.

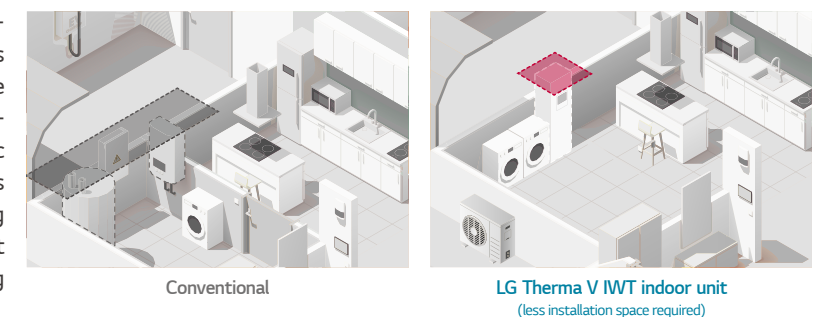

EASY INSTALLATION & MAINTENANCE

Flexible Refrigerant Piping Design

Installation flexibility is enabled by Therma V Split's long pipe length (up to 50 m) and the fact that the refrigerant piping can be connected in three directions: front, side and rear.

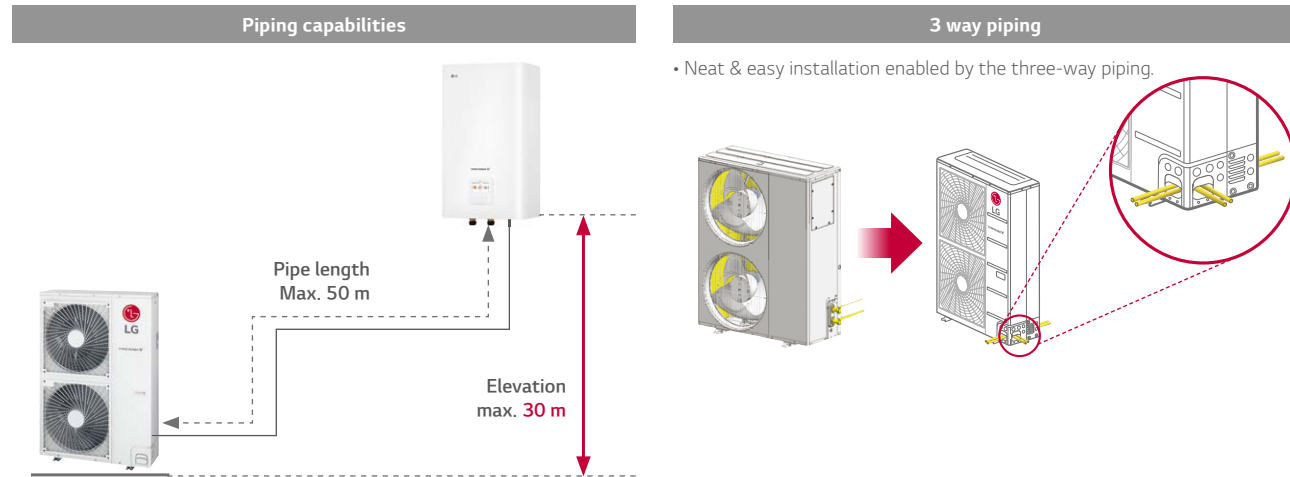

Clip Type Connection for Easy Maintenance

As a clip solution provides for easy maintenance and SVC works, maintenance for main hydronic parts can be done by hands without any special tool.

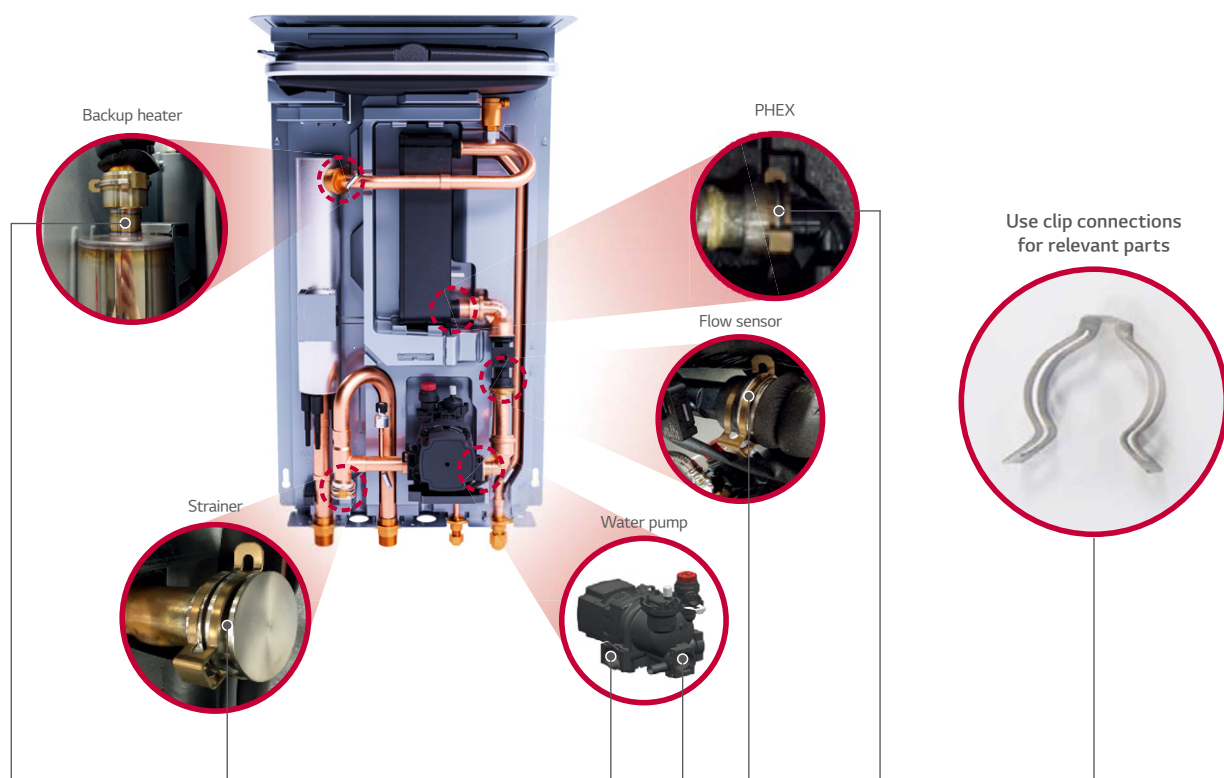

THEIRMA VTM PRODUCTS





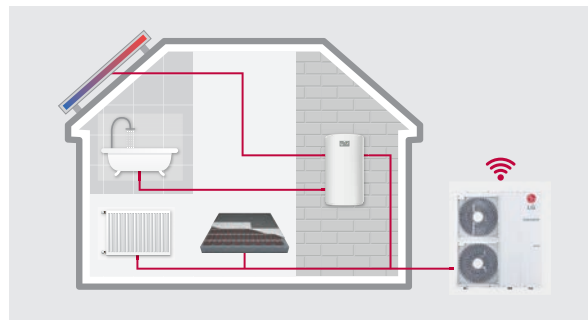
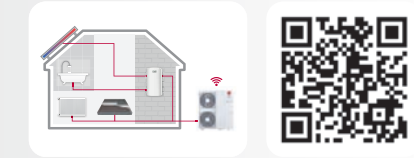

Excellent performance & efficiency



User convenience

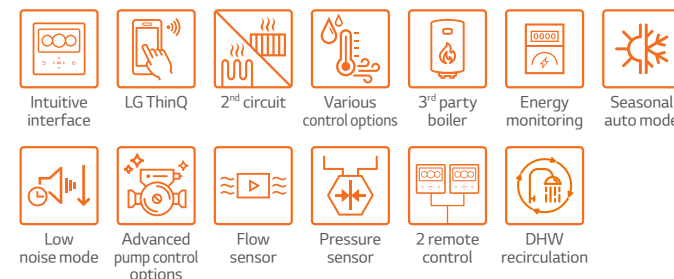

Easy installation & maintenance

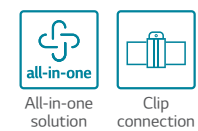

* Detailed description for each function is presented on page 44 – 54.

Energy label

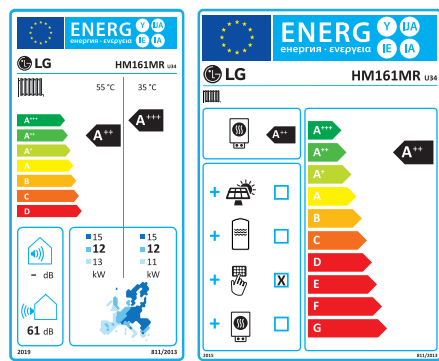

* 16 kW 10 model.
* A+++ to D scale.

R32 Monobloc S Introduction

The Therma V R32 Monobloc S is the 2nd generation of LG's R32 Monobloc series. As implied by "silence" and "supreme," it boasts reduced noise level and best performance in the Therma V series. Combining the indoor and outdoor as one module, it's also connected by only water piping eliminating the need for refrigerant piping. Furthermore, hydronic components like the plate heat exchanger, expansion tank, water pump, flow sensor, pressure sensor, air vent valves, and safety valve are conveniently situated inside the unit. The R32 Monobloc S provides excellent heating performance, especially at low ambient temperature, while producing lower carbon emissions with R32.

Key Components

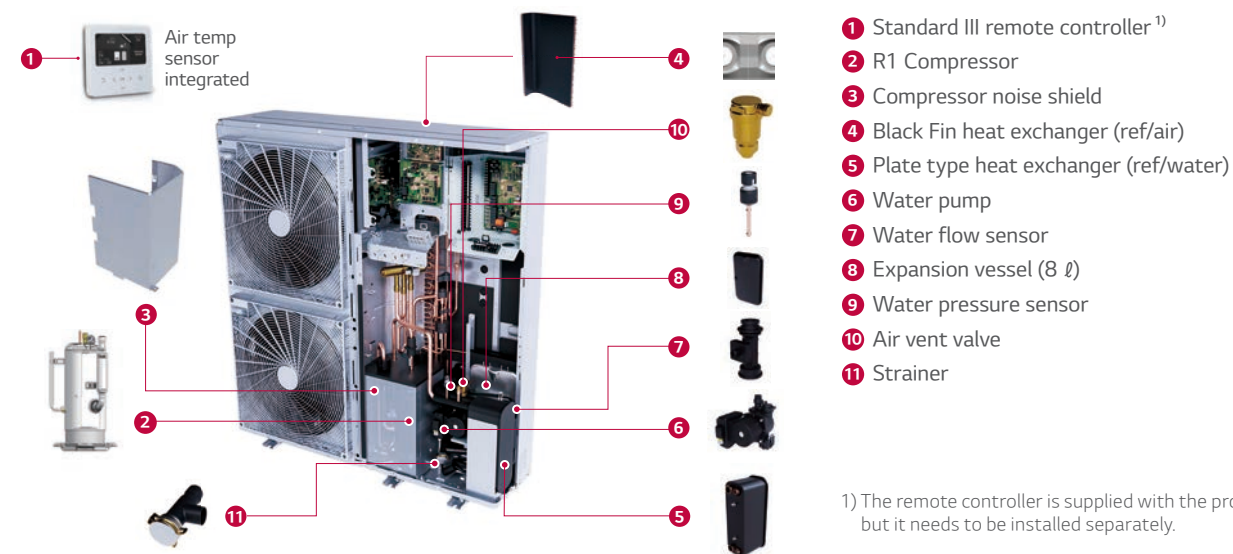

1) The remote controller is supplied with the product, but it needs to be installed separately.

Quiet Mark Certified - creating healthy soundscapes for living spaces

Quiet Mark is the international award for high-performance technologies and solutions battling everyday unwanted noise. It shows that R32 Monobloc S is one of the quietest, or most technically effective products in noise reduction or acoustic properties available on the current market in its category.

Therma V R32 Monobloc S has received the Quiet Mark certification since it has been designed to reach lower acoustic levels in order to meet homeowner expectations in urban areas.



Certified products*:

HM051MR U44 / HM071MR U44 / HM091MR U44
HM093MR U44 / HM121MR U34 / HM123MR U34

* This certification is valid for UK & EU territories only.

Monobloc Concept

R32 Monobloc S is an all-in-one concept, with its reduced weight allowing quicker and easier installations.

- Additional hydronic components are included in the package
- Easier and quicker installation without refrigerant piping work
- The best solution when space heating only is needed

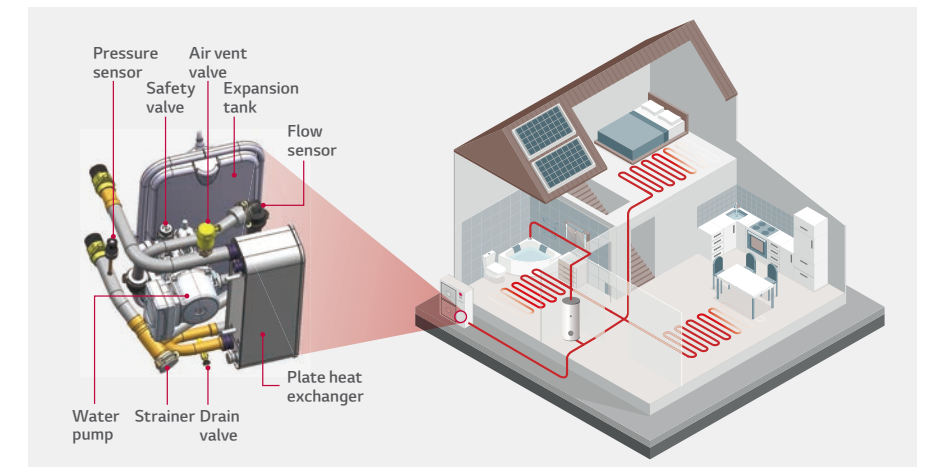

Reduced Noise Level

R32 Monobloc S can be installed at the minimum of 4 m away¹⁾ from neighboring houses while complying with noise-related requirements in most European countries, including Germany. (based on 9 kW model & low noise mode)

Description		Germany	Austria	Switzerland	Netherlands
Sound pressure threshold	Day time	50 dB (A) (06:00 - 22:00)	40 dB (A) (06:00 - 19:00)	40 dB (A) (07:00 - 19:00)	45 dB (A) (07:00 - 19:00)
	Evening	-	35 dB (A) (19:00 - 22:00)	-	-
	Night time	35 dB (A) (22:00 - 06:00)	30 dB (A) (22:00 - 06:00)	35 dB (A) (19:00 - 07:00)	40 dB (A) (19:00 - 07:00)

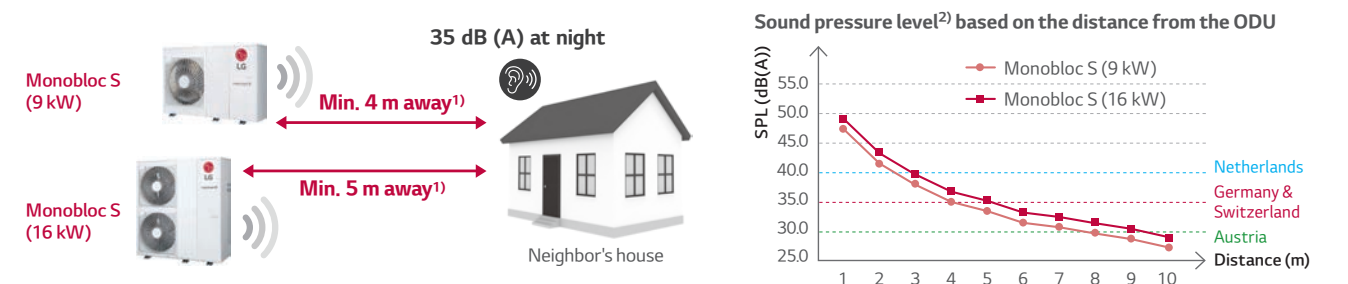

1) Minimum distance to be away from a neighboring property may vary depending on installation conditions and noise regulations in individual countries.
2) Sound pressure level is converted from sound power level of low noise mode based on a tonality penalty of 0 dB and installation in free-field. The directivity index (Q) is assumed as 2.



R32 Monobloc S

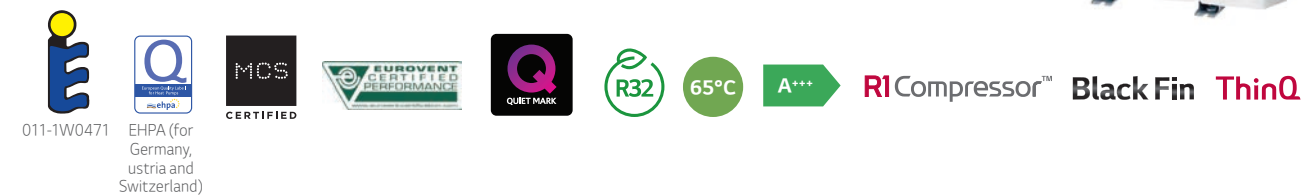

HM051MR U44
HM071MR U44
HM091MR U44
HM093MR U44



Features

- All-in-one outdoor unit
- SCOP up to 4.55 (average climate / low temp. application): 
- SCOP up to 3.20 (average climate / mid temp. application): 
- COP up to 4.70 (outdoor air 7°C / leaving water 35°C)
- 100 % heating capacity at -15°C OAT (@ LWT 35°C)
- Low sound level allowing high installation location flexibility
- Wide operation range (ambient: -25 ~ 35°C / water side: 15 ~ 65°C)
- Built-in water flow & pressure sensors to monitor real-time water circuit
- R32 refrigerant with reduced Global Warming Potential (GWP)
- R1 Compressor
- Improved heat exchanger design (new Black Fin)
- LG ThinQ
- Keymark / EHPA (for Germany, Austria and Switzerland) / MCS / Eurovent / Quiet Mark certification

* The certifications for HM093MR U44 are under development except for MCS certification.

Model line-up

Capacity	Unit	Model name		
		Capacity (kW)		
		5.5	7.0	9.0
1 Phase model 220 - 240 V, 1 Ø, 50 Hz	Monobloc unit	HM051MR U44	HM071MR U44	HM091MR U44
3 Phase model 380 - 415 V, 3 Ø, 50 Hz		-	-	HM093MR U44

Seasonal energy

Description		Unit	HM051MR U44	HM071MR U44	HM091MR U44 HM093MR U44	
Space heating (according to EN14825)	Average climate water outlet 35°C	SCOP	-	4.46	4.48	4.55
		Seasonal space heating efficiency (η _s)	%	175	176	179
		Seasonal space heating eff. class (A+++ to D Scale)	-	A+++	A+++	A+++
	Average climate water outlet 55°C	SCOP	-	3.20	3.20	3.20
		Seasonal space heating efficiency (η _s)	%	125	125	125
		Seasonal space heating eff. class (A+++ to D Scale)	-	A++	A++	A++

Nominal capacity and nominal power input

Description		OAT ¹⁾ (DB)	LWT ²⁾ (DB)	Unit	HM051MR U44	HM071MR U44	HM091MR U44 HM093MR U44
Nominal capacity	Heating	7°C	35°C	kW	5.50	7.00	9.00
		7°C	55°C		5.50	5.50	5.50
	Cooling	2°C	35°C		4.40	5.60	6.80
		35°C	18°C		5.50	7.00	9.00
Nominal power input	Heating	7°C	35°C	kW	1.17	1.49	1.96
		7°C	55°C		2.04	2.04	2.04
	Cooling	2°C	35°C		1.22	1.58	1.94
		35°C	18°C		1.17	1.56	2.14
COP	Heating	7°C	35°C	W/W	4.70	4.70	4.60
		7°C	55°C		2.70	2.70	2.70
	Cooling	2°C	35°C		3.60	3.55	3.50
		35°C	18°C		4.70	4.50	4.20
EER	Cooling	35°C	7°C	W/W	3.30	3.20	3.10

1) OAT: Outdoor Air Temperature
2) LWT: Leaving Water Temperature

Product specification

Technical specification		Unit	HM051MR U44	HM071MR U44	HM091MR U44 HM093MR U44	
Water side	Operation range (leaving water temperature)	Heating	15 - 65			
		Cooling	5 - 27 (16 - 27) ¹⁾			
		DHW	15 - 80 ²⁾			
	Piping connections	Water Circuit	Inlet	Male PT 1" according to ISO 7-1 (tapered pipe threads)		
		Outlet	Male PT 1" according to ISO 7-1 (tapered pipe threads)			
	Rated water flow rate at LWT 35°C		LPM	15.8	20.1	25.9
Refrigerant side	Operation range (outdoor temperature)	Heating	-25 - 35			
		Cooling	5 - 48			
	Compressor	Quantity	EA	1		
		Type	-	Hermetic sealed scroll		
	Refrigerant	Type	-	R32		
		GWP (Global Warming Potential)	-	675		
Precharged amount		g	1,400			
	t-CO2 eq	-	0.945			
Sound power level		Heating	Rated	57		
			Low noise mode	54	55	
Sound pressure level (at 5 m)		Heating	Rated	35		
			Low noise mode	32	33	
Dimensions		Unit	W x H x D	1,239 x 834 x 330		
Weight		Unit	kg	89.5	1 Ø: 89.5 / 3 Ø: 92.5	
Exterior		Color / RAL code		Warm gray / RAL 7044		
Power supply		Voltage, phase, frequency		220-240, 1, 50		
	Rated running current	Heating	A	5.2	6.6	1 Ø: 8.7 / 3 Ø: 2.9
		Cooling	A	5.2	6.9	1 Ø: 9.5 / 3 Ø: 3.2
	Recommended circuit breaker		A	16	20	1 Ø: 25 / 3 Ø: 16
Wiring connections		Power supply cable (included earth, H07RN-F)		4.0 x 3 C		
			mm ² x cores	1 Ø: 4.0 x 3 C / 3 Ø: 2.5 x 5 C		

1) When a fan coil unit is not used.
2) DHW 55 - 80°C Operating is available only when the booster heater is operating.

Note

- Due to our policy of innovation, some specifications may be changed without notification.
- Wiring cable size must comply with the applicable local and national codes. Especially the power cable and circuit breaker should be selected in accordance with that.
- Sound power level is measured on the rated condition in accordance with ISO 9614 standard. Sound pressure level is converted from sound power level based on a tonality penalty of 0 dB and installation in free-field. The directivity index (Q) is assumed as 2. Therefore, these values can be increased owing to ambient conditions during operation. Rated sound power level is in accordance with EN12102-1 under condition of EN14825.
- Performances are in accordance with EN14511 and reflect ErP testing conditions. Above gives the declared values at rated conditions acc. ErP regulation.
 - Rated running current: outdoor temp. 7°C DB / 6°C WB, LWT 35°C
- This product contains fluorinated greenhouse gases.
- All installation sites must be equipped with an earth leakage circuit breaker (ELCB).

Performance Table for Heating Operation

Maximum heating capacity (including defrost effect)

HM051MR U44

Outdoor temperature	LWT 30°C	LWT 35°C	LWT 40°C	LWT 45°C	LWT 50°C	LWT 55°C	LWT 60°C	LWT 65°C
	Capacity (kW)							
-25°C DB	5.50	5.50	5.50	5.50	-	-	-	-
-20°C DB	5.50	5.50	5.50	5.50	5.23	-	-	-
-15°C DB	5.50	5.50	5.50	5.50	5.23	5.23	-	-
-7°C DB	5.50	5.50	5.50	5.50	5.50	5.50	5.50	-
-4°C DB	5.50	5.50	5.50	5.50	5.50	5.50	5.50	5.50
-2°C DB	5.50	5.50	5.50	5.50	5.50	5.50	5.50	5.50
2°C DB	5.50	5.50	5.50	5.50	5.50	5.50	5.50	5.50
7°C DB	5.50	5.50	5.50	5.50	5.50	5.50	5.50	5.50
10°C DB	5.50	5.50	5.50	5.50	5.50	5.50	5.50	5.50
15°C DB	5.50	5.50	5.50	5.50	5.50	5.50	5.50	5.50
18°C DB	5.50	5.50	5.50	5.50	5.50	5.50	5.50	5.50
20°C DB	5.50	5.50	5.50	5.50	5.50	5.50	5.50	5.50
35°C DB	5.50	5.50	5.50	5.50	5.50	5.50	5.50	5.50

HM071MR U44

Outdoor temperature	LWT 30°C	LWT 35°C	LWT 40°C	LWT 45°C	LWT 50°C	LWT 55°C	LWT 60°C	LWT 65°C
	Capacity (kW)							
-25°C DB	5.85	5.85	5.85	5.85	-	-	-	-
-20°C DB	6.43	6.43	6.43	6.43	6.10	-	-	-
-15°C DB	7.00	7.00	7.00	7.00	6.65	6.65	-	-
-7°C DB	7.00	7.00	7.00	7.00	7.00	7.00	7.00	-
-4°C DB	7.00	7.00	7.00	7.00	7.00	7.00	7.00	7.00
-2°C DB	7.00	7.00	7.00	7.00	7.00	7.00	7.00	7.00
2°C DB	7.00	7.00	7.00	7.00	7.00	7.00	7.00	7.00
7°C DB	7.00	7.00	7.00	7.00	7.00	7.00	7.00	7.00
10°C DB	7.00	7.00	7.00	7.00	7.00	7.00	7.00	7.00
15°C DB	7.00	7.00	7.00	7.00	7.00	7.00	7.00	7.00
18°C DB	7.00	7.00	7.00	7.00	7.00	7.00	7.00	7.00
20°C DB	7.00	7.00	7.00	7.00	7.00	7.00	7.00	7.00
35°C DB	7.00	7.00	7.00	7.00	7.00	7.00	7.00	7.00

HM091MR U44 / HM093MR U44

Outdoor temperature	LWT 30°C	LWT 35°C	LWT 40°C	LWT 45°C	LWT 50°C	LWT 55°C	LWT 60°C	LWT 65°C
	Capacity (kW)							
-25°C DB	6.20	6.20	6.20	6.20	-	-	-	-
-20°C DB	7.60	7.60	7.60	7.60	7.22	-	-	-
-15°C DB	9.00	9.00	9.00	9.00	8.55	8.55	-	-
-7°C DB	9.00	9.00	9.00	9.00	9.00	9.00	9.00	-
-4°C DB	9.00	9.00	9.00	9.00	9.00	9.00	9.00	9.00
-2°C DB	9.00	9.00	9.00	9.00	9.00	9.00	9.00	9.00
2°C DB	9.00	9.00	9.00	9.00	9.00	9.00	9.00	9.00
7°C DB	9.00	9.00	9.00	9.00	9.00	9.00	9.00	9.00
10°C DB	9.00	9.00	9.00	9.00	9.00	9.00	9.00	9.00
15°C DB	9.00	9.00	9.00	9.00	9.00	9.00	9.00	9.00
18°C DB	9.00	9.00	9.00	9.00	9.00	9.00	9.00	9.00
20°C DB	9.00	9.00	9.00	9.00	9.00	9.00	9.00	9.00
35°C DB	9.00	9.00	9.00	9.00	9.00	9.00	9.00	9.00

Note
 1. DB: Dry Bulb Temperature (°C), LWT: Leaving Water Temperature (°C)
 2. Direct interpolation is permissible. Do not extrapolate.
 3. Measuring procedure follows EN-14511.
 • Rated values are based on standard conditions and can be found on specifications.
 • Above table values may not be matched according to installation conditions. Except for rated values, the performance is not guaranteed.
 • The rating might slightly vary depending on test standards or countries.
 4. The shaded areas are not guaranteed continuous operation.

Performance Table for Cooling Operation

Maximum cooling capacity

HM051MR U44

Outdoor temperature	LWT 7°C	LWT 10°C	LWT 13°C	LWT 15°C	LWT 18°C	LWT 20°C	LWT 22°C
	Capacity (kW)						
10°C DB	5.50	5.50	5.50	5.50	5.50	5.50	5.50
20°C DB	5.50	5.50	5.50	5.50	5.50	5.50	5.50
30°C DB	5.50	5.50	5.50	5.50	5.50	5.50	5.50
35°C DB	5.50	5.50	5.50	5.50	5.50	5.50	5.50
40°C DB	5.29	5.32	5.36	5.38	5.41	5.43	5.45
45°C DB	5.09	5.15	5.21	5.25	5.31	5.36	5.40

HM071MR U44

Outdoor temperature	LWT 7°C	LWT 10°C	LWT 13°C	LWT 15°C	LWT 18°C	LWT 20°C	LWT 22°C
	Capacity (kW)						
10°C DB	7.00	7.00	7.00	7.00	7.00	7.00	7.00
20°C DB	7.00	7.00	7.00	7.00	7.00	7.00	7.00
30°C DB	7.00	7.00	7.00	7.00	7.00	7.00	7.00
35°C DB	7.00	7.00	7.00	7.00	7.00	7.00	7.00
40°C DB	6.36	6.45	6.55	6.61	6.71	6.77	6.84
45°C DB	5.71	5.82	5.92	5.99	6.10	6.17	6.24

HM091MR U44 / HM093MR U44

Outdoor temperature	LWT 7°C	LWT 10°C	LWT 13°C	LWT 15°C	LWT 18°C	LWT 20°C	LWT 22°C
	Capacity (kW)						
10°C DB	9.00	9.00	9.00	9.00	9.00	9.00	9.00
20°C DB	9.00	9.00	9.00	9.00	9.00	9.00	9.00
30°C DB	9.00	9.00	9.00	9.00	9.00	9.00	9.00
35°C DB	9.00	9.00	9.00	9.00	9.00	9.00	9.00
40°C DB	7.66	7.66	7.65	7.65	7.65	7.65	7.65
45°C DB	6.31	6.35	6.39	6.42	6.45	6.48	6.51

Note
 1. DB: Dry Bulb Temperature (°C), LWT: Leaving Water Temperature (°C)
 2. Direct interpolation is permissible. Do not extrapolate.
 3. Measuring procedure follows EN-14511.
 • Rated values are based on standard conditions and can be found on specifications.
 • Above table values may not be matched according to installation conditions. Except for rated values, the performance is not guaranteed.
 • The rating might slightly vary depending on test standards or countries.
 4. The shaded areas are not guaranteed continuous operation.

Drawings

Category	Unit	Model name		
		Capacity (kW)		
		5.5	7.0	9.0
1 Phase model 220 - 240 V, 1 Ø, 50 Hz	Monobloc unit	HM051MR U44	HM071MR U44	HM091MR U44
3 Phase model 380 - 415 V, 3 Ø, 50 Hz		-	-	HM093MR U44

HM051MR U44 / HM071MR U44 / HM091MR U44 / HM093MR U44

[Unit: mm]

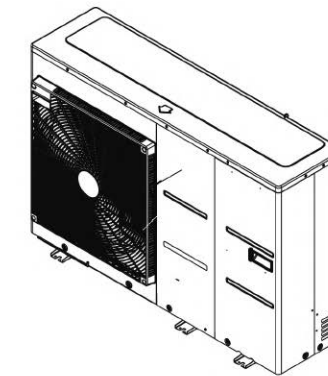
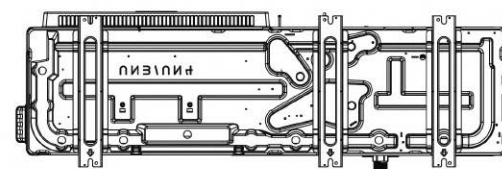
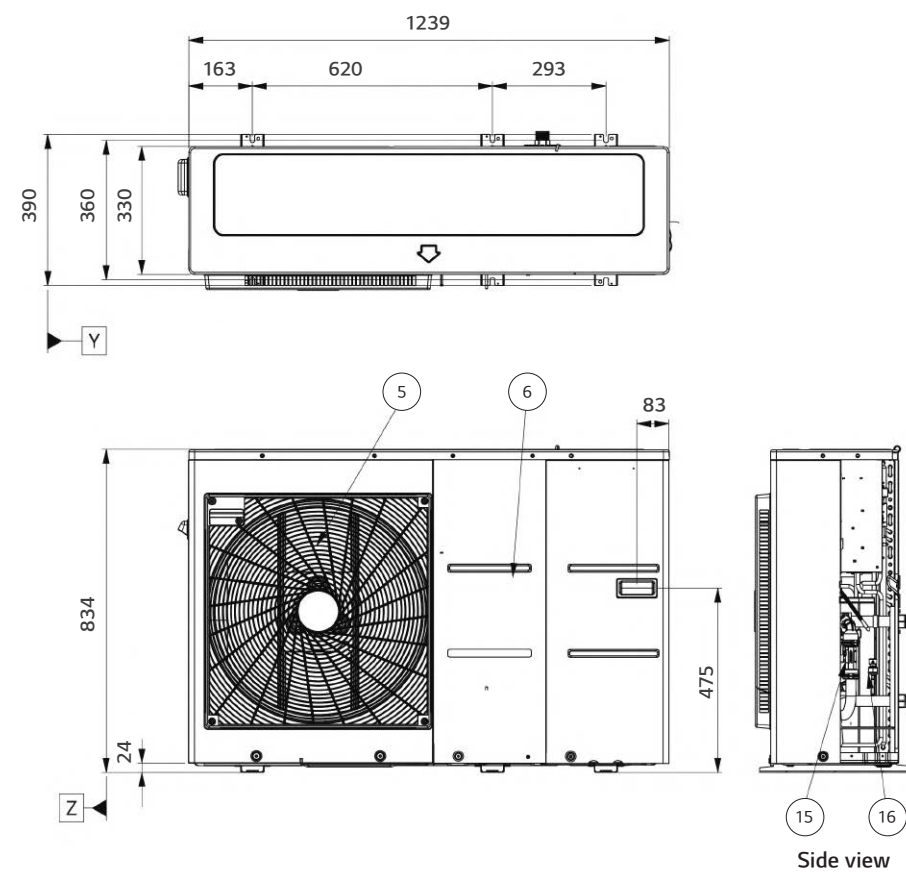

3D view

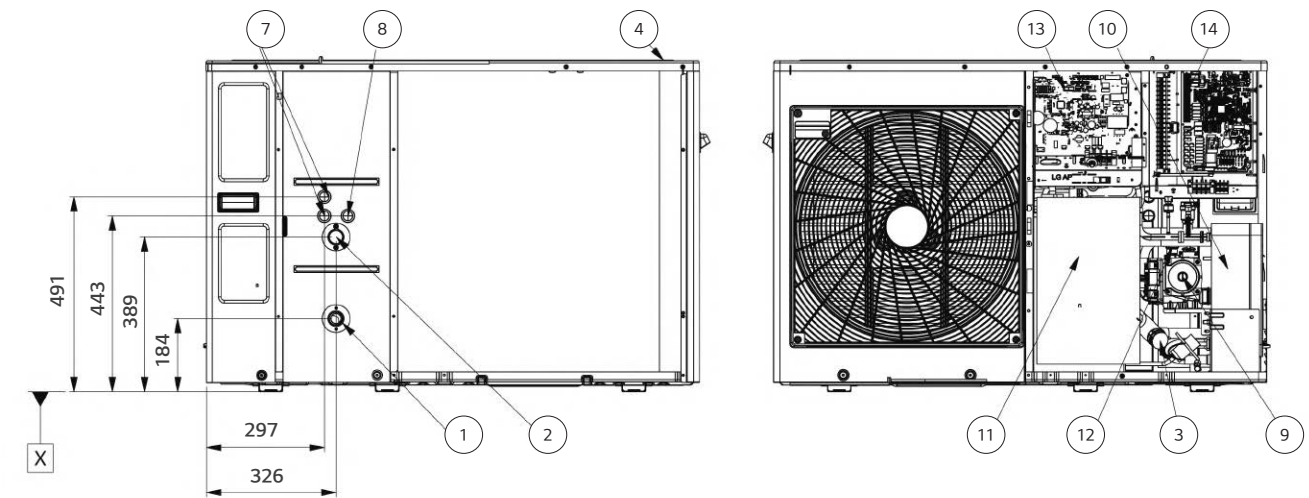

No.	Part name	Description
1	Entering water pipe	Male PT 1" according to ISO 7-1 (tapered pipe threads)
2	Leaving water pipe	Male PT 1" according to ISO 7-1 (tapered pipe threads)
3	Strainer	Filtering and stacking particles inside circulating water
4	Top cover	-
5	Front panel	-
6	Side panel	-
7	Low voltage	Communication cable hole
8	Unit power	Power cable hole
9	Water pump	To circulate water inside the system
10	Plate heat exchanger	Heat exchange between refrigerant and water
11	Compressor shield panel	-
12	Safety valve	Open at water pressure 3 bar
13	Indoor control box	Indoor PCB and terminal blocks
14	Outdoor control box	Outdoor PCB and terminal blocks
15	Flow sensor	To measure the water flow rate (5-80 LPM)
16	Pressure sensor	To measure the water pressure (0-2 MPa)

R32 Monobloc S



- HM121MR U34
- HM141MR U34
- HM161MR U34
- HM123MR U34
- HM143MR U34
- HM163MR U34

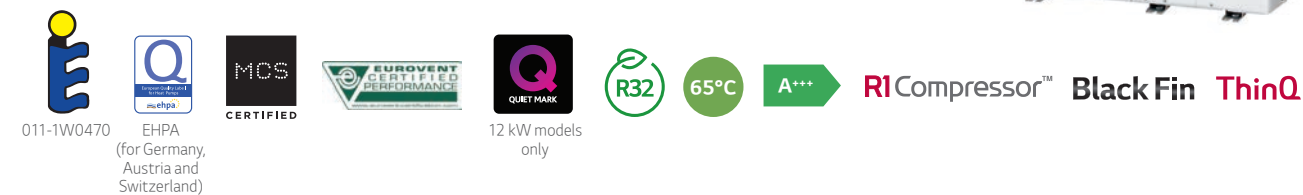

Features

- All-in-one outdoor unit
- SCOP up to 4.67 (average climate / low temp. application): **A+++**
SCOP up to 3.47 (average climate / mid temp. application): **A++**
- COP up to 4.90 (outdoor air 7°C / leaving water 35°C)
- 100 % heating capacity at -15°C OAT (@ LWT 35°C, except for 16 kW model)
- Low sound level allowing high installation location flexibility
- Wide operation range (ambient: -25 ~ 35°C / water side: 15 ~ 65°C)
- Built-in water flow & pressure sensors to monitor real-time water circuit
- R32 refrigerant with reduced Global Warming Potential (GWP)
- R1 Compressor
- Improved heat exchanger design (new Black Fin)
- LG ThinQ
- Keymark / EHPA (for Germany, Austria and Switzerland) / MCS / Eurovent / Quiet Mark (12 kW only) certification

Model line-up

Capacity	Unit	Model name		
		Capacity (kW)		
		12.0	14.0	16.0
1 Phase model 220 - 240 V, 1 Ø, 50 Hz	Monobloc unit	HM121MR U34	HM141MR U34	HM161MR U34
3 Phase model 380 - 415 V, 3 Ø, 50 Hz		HM123MR U34	HM143MR U34	HM163MR U34

Seasonal energy

Description	Unit	HM121MR U34 (1 Ø)	HM141MR U34 (1 Ø)	HM161MR U34 (1 Ø)		
		HM123MR U34 (3 Ø)	HM143MR U34 (3 Ø)	HM163MR U34 (3 Ø)		
Space heating (according to EN14825)	Average climate water outlet 35°C	SCOP	-	4.67	4.62	4.53
		Seasonal space heating efficiency (η _s)	%	184	182	178
		Seasonal space heating eff. class (A+++ to D Scale)	-	A+++	A+++	A+++
	Average climate water outlet 55°C	SCOP	-	3.47	3.46	3.45
		Seasonal space heating efficiency (η _s)	%	136	135	135
		Seasonal space heating eff. class (A+++ to D Scale)	-	A++	A++	A++

Nominal capacity and nominal power input

Description	OAT ¹⁾ (DB)	LWT ²⁾ (DB)	Unit	HM121MR U34 (1 Ø)	HM141MR U34 (1 Ø)	HM161MR U34 (1 Ø)
				HM123MR U34 (3 Ø)	HM143MR U34 (3 Ø)	HM163MR U34 (3 Ø)
Nominal capacity	Heating	7°C	35°C	12.00	14.00	16.00
		7°C	55°C	11.00	11.50	12.00
	Cooling	2°C	35°C	11.00	12.00	13.80
		35°C	18°C	12.00	14.00	16.00
Nominal power input	Heating	7°C	35°C	2.45	2.92	3.40
		7°C	55°C	3.79	4.04	4.29
	Cooling	2°C	35°C	3.01	3.31	3.83
		35°C	18°C	2.53	3.26	4.00
COP	Heating	7°C	35°C	4.90	4.80	4.70
		7°C	55°C	2.90	2.85	2.80
	Cooling	2°C	35°C	3.65	3.63	3.60
		35°C	18°C	4.75	4.30	4.00
EER				3.30	3.30	3.10

1) OAT : Outdoor Air Temperature
2) LWT : Leaving Water Temperature

Product specification

Technical specification			Unit	HM121MR U34	HM141MR U34	HM161MR U34	HM123MR U34	HM143MR U34	HM163MR U34
Water side	Operation range (leaving water temperature)	Heating	Min. - Max.	15 ~ 65					
		Cooling		5 ~ 27 (16 ~ 27) ¹⁾					
		DHW		15 ~ 80 ²⁾					
	Piping connections	Water circuit	Inlet	Male PT 1" according to ISO 7-1 (tapered pipe threads)					
		Outlet	Male PT 1" according to ISO 7-1 (tapered pipe threads)						
	Rated water flow rate at LWT 35°C		LPM	34.5	40.3	46.0	34.5	40.3	46.0
Refrigerant side	Operation range (outdoor temp.)	Heating	Min. - Max.	-25 ~ 35					
		Cooling		5 ~ 48					
	Compressor	Quantity	EA	1					
		Type	-	Hermetic sealed scroll					
	Refrigerant	Type	-	R32					
		GWP (Global Warming Potential)	-	675					
Precharged amount		g	2,000						
	t-CO ₂ eq	-	1.350						
Sound power level	Heating	Rated	dB(A)	60	61	60	60	61	61
		Low noise mode		56	57	56	57	57	
Sound pressure level (at 5m)	Heating	Rated	dB(A)	38	39	38	38	39	39
		Low noise mode		34	35	34	35	35	
Dimensions	Unit	W x H x D	mm	1,239 x 1,380 x 330					
Weight	Unit		kg	119.1					
Exterior	Color / RAL code		-	Warm gray / RAL 7044					
Power supply	Voltage, phase, frequency		V, Ø, Hz	220-240, 1, 50			380-415, 3, 50		
	Rated running current	Heating	A	10.9	12.9	15.1	3.6	4.3	5.0
		Cooling	A	11.2	14.4	17.7	3.7	4.8	5.9
	Recommended circuit breaker		A	40			16		
Wiring connections	Power supply cable (included earth, H07RN-F)		mm ² x cores	6.0 x 3 C			4.0 x 5 C		

1) When a fan coil unit is not used.
2) DHW 55 ~ 80°C Operating is available only when the booster heater is operating.

- Note
1. Due to our policy of innovation, some specifications may be changed without notification.
 2. Wiring cable size must comply with the applicable local and national codes. Especially the power cable and circuit breaker should be selected in accordance with that.
 3. Sound power level is measured on the rated condition in accordance with ISO 9614 standard. Sound pressure level is converted from sound power level based on a tonality penalty of 0 dB and installation in free-field. The directivity index (Q) is assumed as 2. Therefore, these values can be increased owing to ambient conditions during operation. Rated sound power level is in accordance with EN12102-1 under condition of EN14825.
 4. Performances are in accordance with EN14511 and reflect ErP testing conditions. Above gives the declared values at rated conditions acc. ErP regulation.
 - Rated running current: Outdoor Temp. 7°C DB / 6°C WB, LWT 35°C
 5. This product contains fluorinated greenhouse gases.
 6. All installation sites must be equipped with an earth leakage circuit breaker (ELCB).

Performance Table for Heating Operation

Maximum heating capacity (including defrost effect)

HM121MR U34 / HM123MR U34

Outdoor temperature	LWT 30°C	LWT 35°C	LWT 40°C	LWT 45°C	LWT 50°C	LWT 55°C	LWT 60°C	LWT 65°C
	Capacity (kW)							
-25°C DB	9.50	9.50	9.50	9.50	-	-	-	-
-20°C DB	10.75	10.75	10.75	10.75	10.21	-	-	-
-15°C DB	12.00	12.00	12.00	12.00	11.50	11.50	-	-
-7°C DB	12.00	12.00	12.00	12.00	12.00	12.00	12.00	-
-4°C DB	12.00	12.00	12.00	12.00	12.00	12.00	12.00	12.00
-2°C DB	12.00	12.00	12.00	12.00	12.00	12.00	12.00	12.00
2°C DB	12.00	12.00	12.00	12.00	12.00	12.00	12.00	12.00
7°C DB	12.00	12.00	12.00	12.00	12.00	12.00	12.00	12.00
10°C DB	12.00	12.00	12.00	12.00	12.00	12.00	12.00	12.00
15°C DB	12.00	12.00	12.00	12.00	12.00	12.00	12.00	12.00
18°C DB	12.00	12.00	12.00	12.00	12.00	12.00	12.00	12.00
20°C DB	12.00	12.00	12.00	12.00	12.00	12.00	12.00	12.00
35°C DB	12.00	12.00	12.00	12.00	12.00	12.00	12.00	12.00

HM141MR U34 / HM143MR U34

Outdoor temperature	LWT 30°C	LWT 35°C	LWT 40°C	LWT 45°C	LWT 50°C	LWT 55°C	LWT 60°C	LWT 65°C
	Capacity (kW)							
-20°C DB	12.00	12.00	12.00	12.00	11.40	-	-	-
-15°C DB	14.00	14.00	14.00	14.00	13.30	13.30	-	-
-7°C DB	14.00	14.00	14.00	14.00	14.00	14.00	14.00	-
-4°C DB	14.00	14.00	14.00	14.00	14.00	14.00	14.00	14.00
-2°C DB	14.00	14.00	14.00	14.00	14.00	14.00	14.00	14.00
2°C DB	14.00	14.00	14.00	14.00	14.00	14.00	14.00	14.00
7°C DB	14.00	14.00	14.00	14.00	14.00	14.00	14.00	14.00
10°C DB	14.00	14.00	14.00	14.00	14.00	14.00	14.00	14.00
15°C DB	14.00	14.00	14.00	14.00	14.00	14.00	14.00	14.00
18°C DB	14.00	14.00	14.00	14.00	14.00	14.00	14.00	14.00
20°C DB	14.00	14.00	14.00	14.00	14.00	14.00	14.00	14.00
35°C DB	14.00	14.00	14.00	14.00	14.00	14.00	14.00	14.00

HM161MR U34 / HM163MR U34

Outdoor temperature	LWT 30°C	LWT 35°C	LWT 40°C	LWT 45°C	LWT 50°C	LWT 55°C	LWT 60°C	LWT 65°C
	Capacity (kW)							
-25°C DB	10.50	10.50	10.50	10.50	-	-	-	-
-20°C DB	13.25	13.25	13.25	13.25	12.59	-	-	-
-15°C DB	16.00	14.40	14.40	14.40	13.68	13.68	-	-
-7°C DB	16.00	16.00	16.00	16.00	16.00	16.00	16.00	-
-4°C DB	16.00	16.00	16.00	16.00	16.00	16.00	16.00	16.00
-2°C DB	16.00	16.00	16.00	16.00	16.00	16.00	16.00	16.00
2°C DB	16.00	16.00	16.00	16.00	16.00	16.00	16.00	16.00
7°C DB	16.00	16.00	16.00	16.00	16.00	16.00	16.00	16.00
10°C DB	16.00	16.00	16.00	16.00	16.00	16.00	16.00	16.00
15°C DB	16.00	16.00	16.00	16.00	16.00	16.00	16.00	16.00
18°C DB	16.00	16.00	16.00	16.00	16.00	16.00	16.00	16.00
20°C DB	16.00	16.00	16.00	16.00	16.00	16.00	16.00	16.00
35°C DB	16.00	16.00	16.00	16.00	16.00	16.00	16.00	16.00

Note

1. DB: Dry Bulb Temperature (°C), LWT: Leaving Water Temperature (°C)
2. Direct interpolation is permissible. Do not extrapolate.
3. Measuring procedure follows EN-14511.
 - Rated values are based on standard conditions and can be found on specifications.
 - Above table values may not be matched according to installation conditions. Except for rated values, the performance is not guaranteed.
 - The rating might slightly vary depending on test standards or countries.
4. The shaded areas are not guaranteed continuous operation.

Performance Table for Cooling Operation

Maximum cooling capacity

HM121MR U34 / HM123MR U34

Outdoor temperature	LWT 7°C	LWT 10°C	LWT 13°C	LWT 15°C	LWT 18°C	LWT 20°C	LWT 22°C
	Capacity (kW)						
10°C DB	12.00	12.00	12.00	12.00	12.00	12.00	12.00
20°C DB	12.00	12.00	12.00	12.00	12.00	12.00	12.00
30°C DB	12.00	12.00	12.00	12.00	12.00	12.00	12.00
35°C DB	12.00	12.00	12.00	12.00	12.00	12.00	12.00
40°C DB	11.05	11.19	11.33	11.43	11.57	11.67	11.76
45°C DB	10.10	10.37	10.64	10.83	11.10	11.28	11.46

HM141MR U34 / HM143MR U34

Outdoor temperature	LWT 7°C	LWT 10°C	LWT 13°C	LWT 15°C	LWT 18°C	LWT 20°C	LWT 22°C
	Capacity (kW)						
10°C DB	12.50	12.80	13.10	13.30	13.60	13.80	14.00
20°C DB	14.00	14.00	14.00	14.00	14.00	14.00	14.00
30°C DB	14.00	14.00	14.00	14.00	14.00	14.00	14.00
35°C DB	14.00	14.00	14.00	14.00	14.00	14.00	14.00
40°C DB	12.35	12.60	12.84	13.01	13.26	13.42	13.59
45°C DB	10.69	11.19	11.69	12.02	12.51	12.84	13.17

HM161MR U34 / HM163MR U34

Outdoor temperature	LWT 7°C	LWT 10°C	LWT 13°C	LWT 15°C	LWT 18°C	LWT 20°C	LWT 22°C
	Capacity (kW)						
10°C DB	13.00	13.60	14.20	14.60	15.20	15.60	16.00
20°C DB	16.00	16.00	16.00	16.00	16.00	16.00	16.00
30°C DB	16.00	16.00	16.00	16.00	16.00	16.00	16.00
35°C DB	16.00	16.00	16.00	16.00	16.00	16.00	16.00
40°C DB	13.60	13.96	14.32	14.56	14.92	15.16	15.40
45°C DB	11.20	11.76	12.32	12.69	13.25	13.62	14.00

Note

1. DB: Dry Bulb Temperature (°C), LWT: Leaving Water Temperature (°C)
2. Direct interpolation is permissible. Do not extrapolate.
3. Measuring procedure follows EN-14511.
 - Rated values are based on standard conditions and can be found on specifications.
 - Above table values may not be matched according to installation conditions. Except for rated values, the performance is not guaranteed.
 - The rating might slightly vary depending on test standards or countries.
4. The shaded areas are not guaranteed continuous operation.

Drawings

Category	Unit	Model name		
		Capacity (kW)		
		12.0	14.0	16.0
1 Phase model 220 - 240 V, 1 Ø, 50 Hz	Monobloc unit	HM121MR U34	HM141MR U34	HM161MR U34
3 Phase model 380 - 415 V, 3 Ø, 50 Hz		HM123MR U34	HM143MR U34	HM163MR U34

[Unit: mm]

HM121MR U34 / HM141MR U34 / HM161MR U34
HM123MR U34 / HM143MR U34 / HM163MR U34

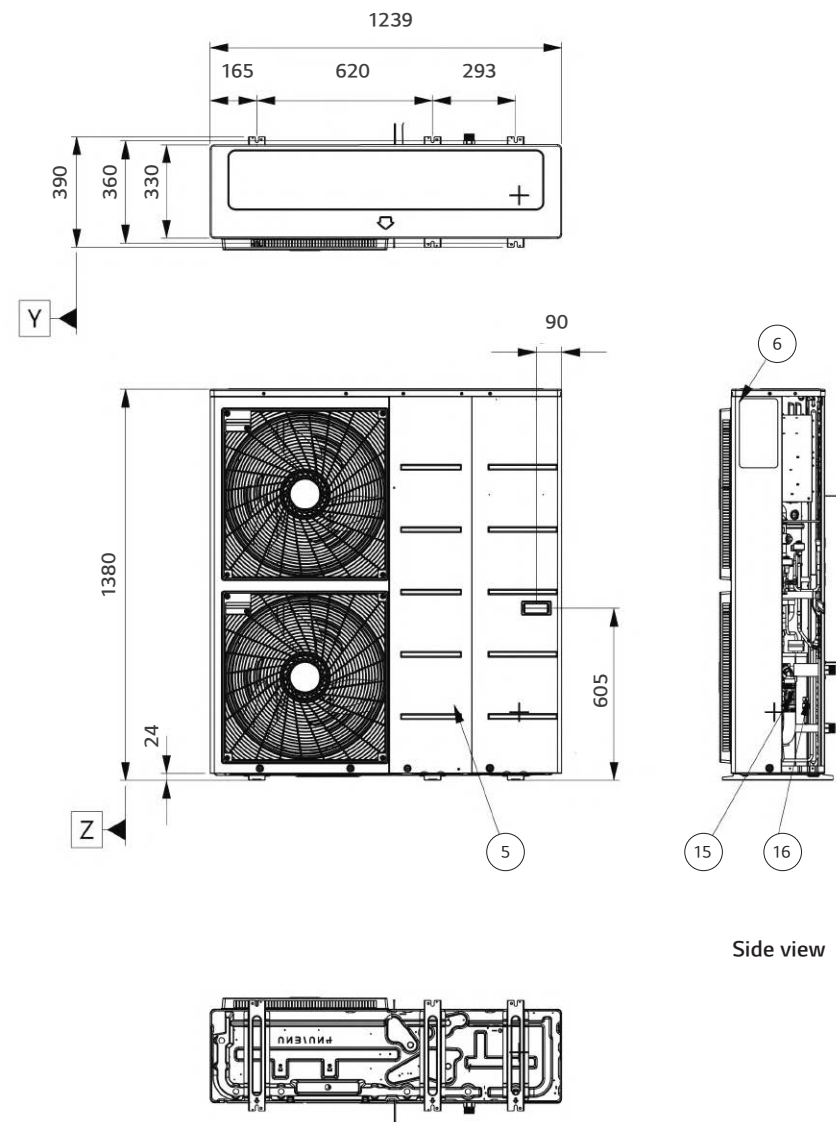

Side view

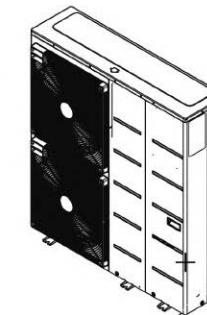

3D view

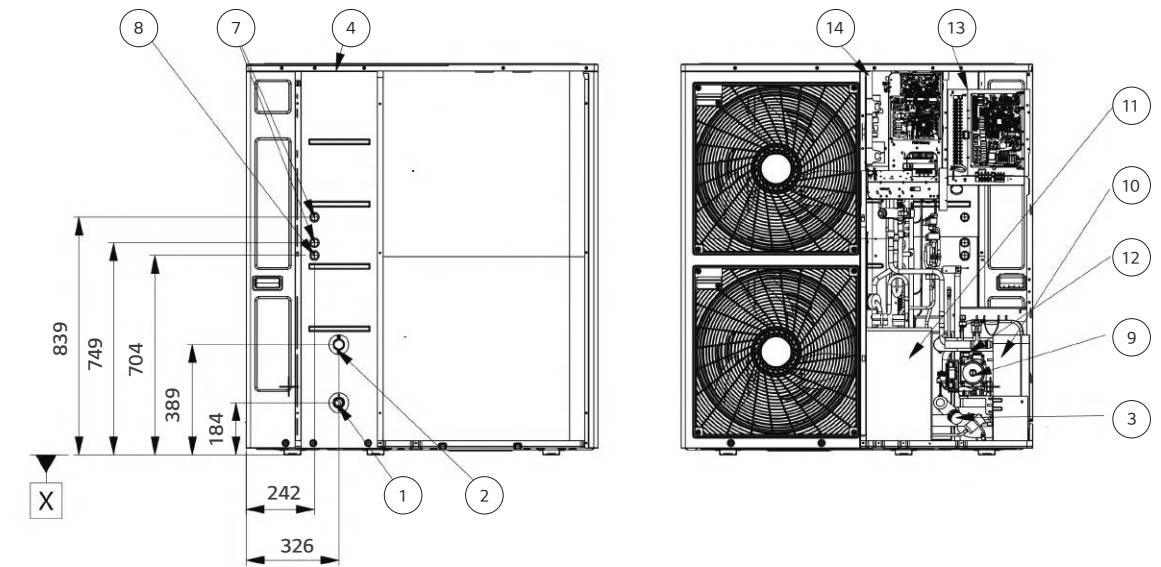

No.	Part name	Description
1	Entering water pipe	Male PT 1" according to ISO 7-1 (tapered pipe threads)
2	Leaving water pipe	Male PT 1" according to ISO 7-1 (tapered pipe threads)
3	Strainer	Filtering and stacking particles inside circulating water
4	Top cover	-
5	Front panel	-
6	Side panel	-
7	Low voltage	Communication cable hole
8	Unit power	Power cable hole
9	Water pump	To circulate water inside the system
10	Plate heat exchanger	Heat exchange between refrigerant and water
11	Compressor shield panel	-
12	Safety valve	Open at water pressure 3 bar
13	Indoor control box	Indoor PCB and terminal blocks
14	Outdoor control box	Outdoor PCB and terminal blocks
15	Flow sensor	To measure the water flow rate (5-80 LPM)
16	Pressure sensor	To measure the water pressure (0-2 MPa)

Electric Backup Heater

HA031M E1
HA061M E1
HA063M E1

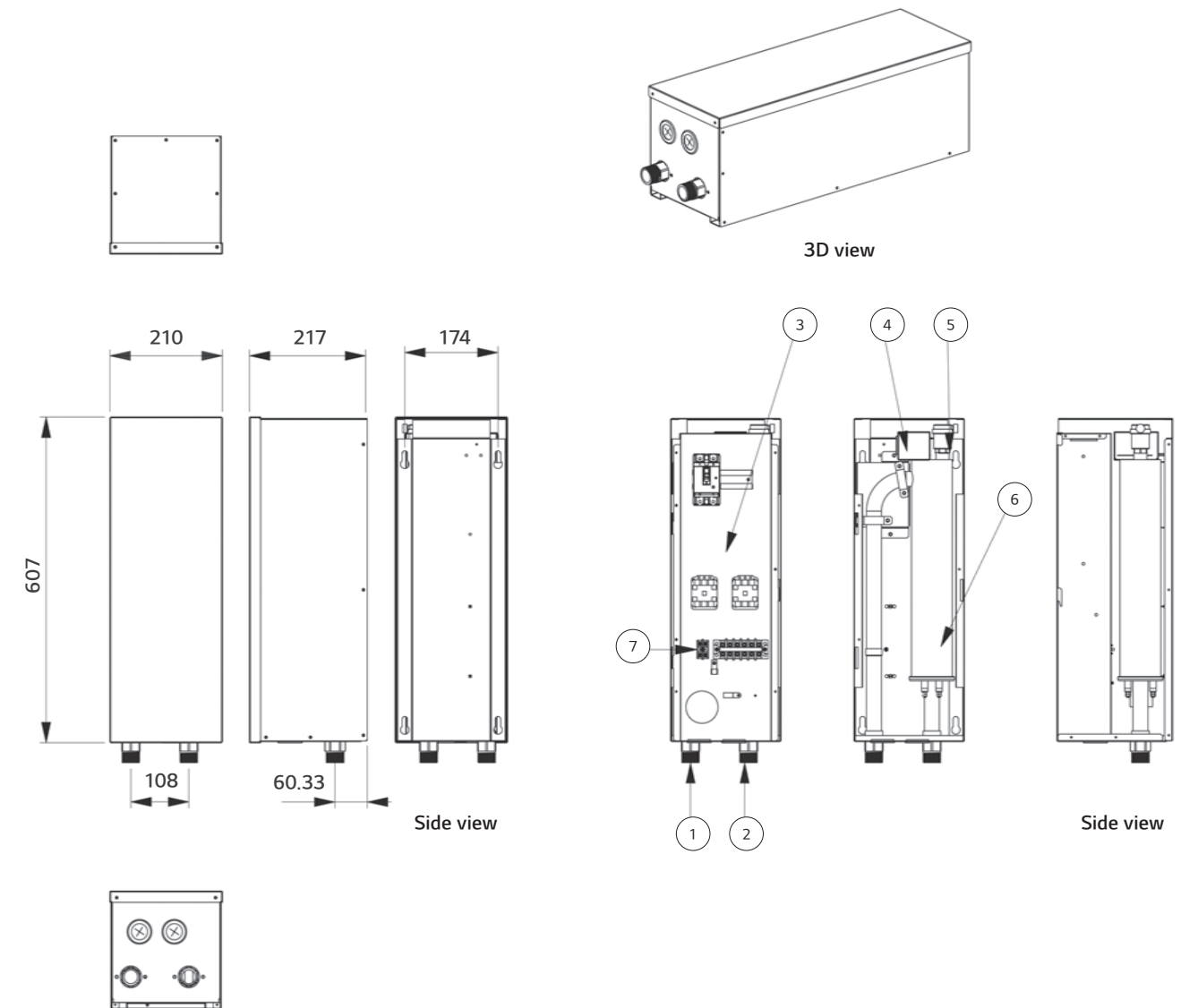

Backup heater specification

Electrical specification		Unit	HA031M E1	HA061M E1	HA063M E1
Backup heater	Type	-	Sheath		
	Number of heating coil	EA	1	2	3
	Capacity combination	kW	3.0	3.0 + 3.0	2.0 + 2.0 + 2.0
	Heating steps	Step	1	2	1
	Power supply	V, Ø, Hz	220 - 240, 1, 50		380 - 415, 3, 50
	Rated running current	A	12.5	25.0	8.7
	Dimensions (W x H x D)	mm	210 x 607 x 217		
	Net weight (unit)	kg	12.8	13.4	13.1
Wiring connections	Power supply cable (included earth, H07RN-F)	mm ² x cores	1.5 x 3 C	4.0 x 3 C	2.5 x 4 C
	Communication cable (H07RN-F)	mm ² x cores	0.75 x 4 C		0.75 x 2 C

Note
1. Due to our policy of innovation some specifications may be changed without notification.
2. Wiring cable size must comply with the applicable local and national codes.
Especially the power cable and circuit breaker should be selected in accordance with that.

No.	Part name	Description
1	Leaving water pipe	Male PT 1" according to ISO 7-1 (tapered pipe threads)
2	Entering water pipe	Male PT 1" according to ISO 7-1 (tapered pipe threads)
3	Control box	Circuit breaker, Magnetic switch, Terminal blocks
4	Thermal switch	Cut-off power input to E/heater at 90°C
5	Air vent	Air purging when charging water
6	Electric heater	Refer the related information
7	Backup heater outlet sensor	Connect to unit (heat pump)

THERMAV™ 

R32 HYDROSPLIT HYDRO BOX



THERMA V R32 HYDROSPLIT HYDRO BOX

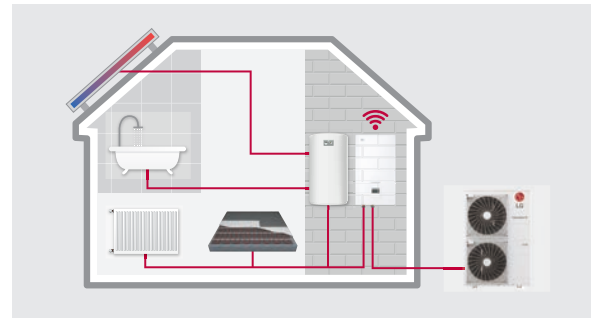
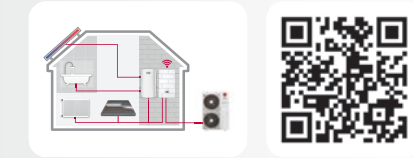

Energy Label

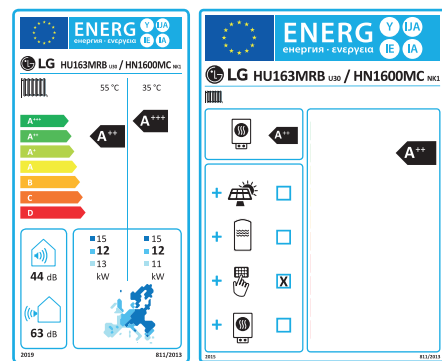

* 16 kW 3 Ø model.
* A+++ to D scale.

Excellent performance & efficiency



User convenience

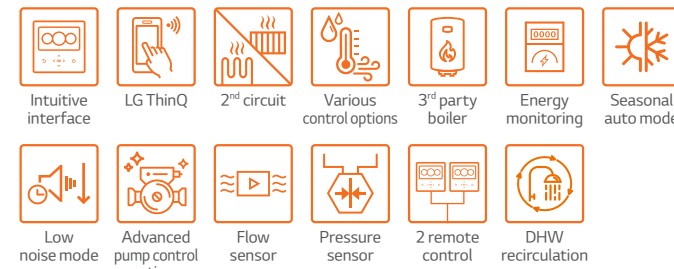

Easy installation & maintenance

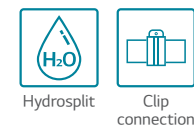

* Detailed description for each function is presented on page 44 – 54.

R32 Hydrosplit Hydro Box Introduction

The Therma V R32 Hydrosplit Hydro Box is a heating and cooling solution, where indoor and outdoor units are connected by water pipes, while the unit's heat exchanger is located with the outdoor unit, thus eliminating the risk of indoor refrigerant leakage, which makes it perfect for renovation projects.

Key Components

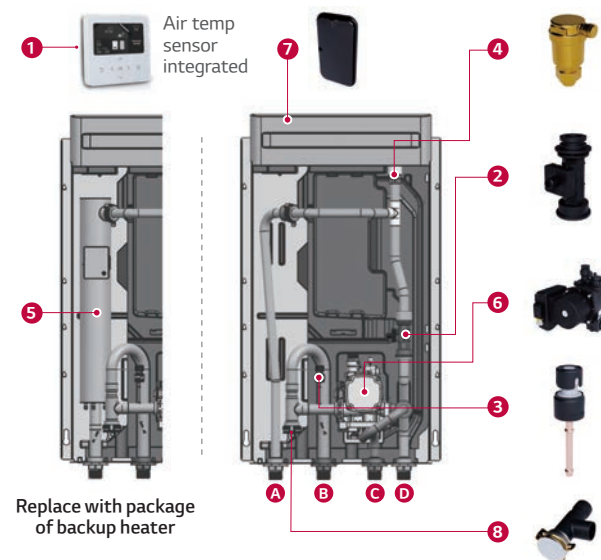

- 1 Standard III remote controller (attached on the front panel)
 - 2 Flow sensor
 - 3 Water pressure sensor
 - 4 Air vent valve
 - 5 Backup electric heater (6 kW, accessory)
 - 6 Water pump
 - 7 Expansion vessel (8 ℓ)
 - 8 Strainer
- A Heating circuit outlet pipe (male PT 1")
 - B Heating circuit inlet pipe (male PT 1")
 - C Outlet pipe to outdoor unit (male PT 1")
 - D Inlet pipe from outdoor unit (male PT 1")

Replace with package of backup heater

Hydrosplit Concept

The Therma V R32 Hydrosplit Hydro Box connects an IDU and ODU by water pipes due to the heat exchanger's location in the outdoor unit, thus reducing the risk of indoor refrigerant leakage.

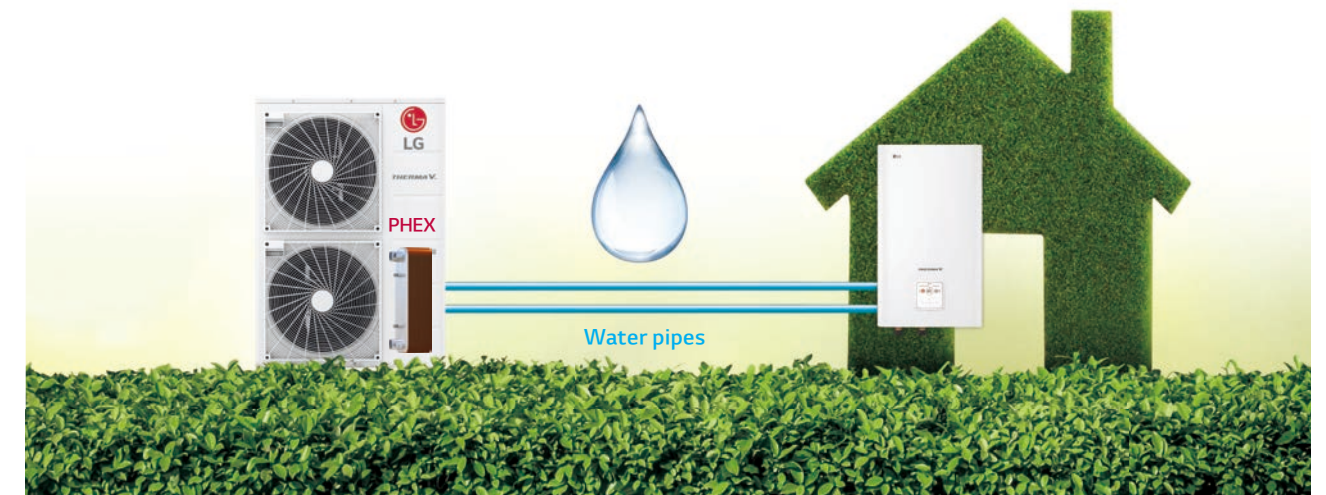

No Risk of Indoor Refrigerant Leakage

The Hydrosplit architecture, with no refrigerant circulating indoors, makes it possible to expand the living space, as the minimum floor area requirements do not apply.

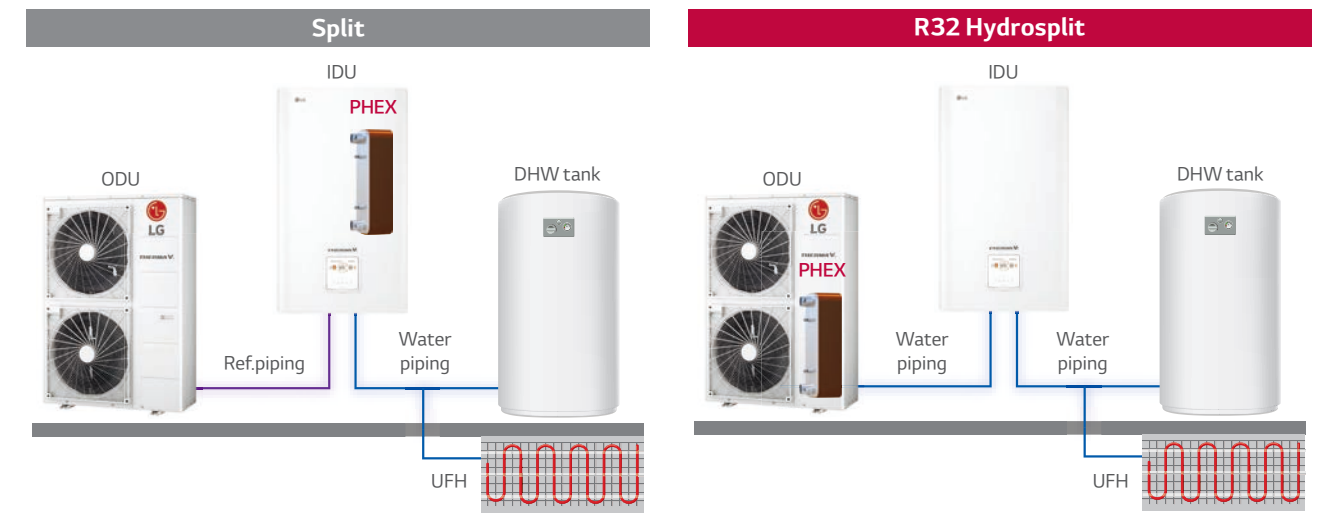

If piping length between IDU and ODU is 30 m

The IDU should be installed in a room with a floor area larger than 10 m²

1) Total Ref. Amount 2.7 kg
- Pre-Charged Ref. Amount : 2.1 kg
- Additional Ref. Charge Amount for 30 m : 0.6 kg

2) Based on 1.5 m installed height
3) IEC 60335-2-40 6 th edition applied

No minimum floor area requirement

R32 Hydrosplit Hydro Box



Indoor unit

HN1600MC NK1

Outdoor unit

HU121MRB U30 / HU123MRB U30

HU141MRB U30 / HU143MRB U30

HU161MRB U30 / HU163MRB U30



Features

- Water pipes connect IDU & ODU
- SCOP up to 4.60 (average climate / low temp. application): **A+++**
- SCOP up to 3.50 (average climate / mid temp. application): **A++**
- COP up to 5.04 (outdoor air 7°C / leaving water 35°C)
- 100 % heating capacity at -7°C OAT (@ LWT 35°C)
- Wide operation range (ambient: -25 ~ 35°C / water side: 15 ~ 65°C)
- Built-in water flow & pressure sensors to monitor real-time water circuit
- R32 refrigerant with reduced Global Warming Potential (GWP)
- R1 Compressor
- Black Fin heat exchanger
- LG ThinQ
- Keymark / EHPA (for Germany, Austria and Switzerland) / MCS / Eurovent certification

Model line-up

Category	Unit	Model name		
		Capacity (kW)		
		12.0	14.0	16.0
1 Phase model 220 - 240 V, 1 Ø, 50 Hz	Outdoor unit	HU121MRB U30	HU141MRB U30	HU161MRB U30
	Indoor unit	HN1600MC NK1		
3 Phase model 380 - 415 V, 3 Ø, 50 Hz	Outdoor unit	HU123MRB U30	HU143MRB U30	HU163MRB U30
	Indoor unit	HN1600MC NK1		

Seasonal energy

Description	Outdoor unit	HU121MRB U30 (1 Ø)	HU141MRB U30 (1 Ø)	HU161MRB U30 (1 Ø)		
		HU123MRB U30 (3 Ø)	HU143MRB U30 (3 Ø)	HU163MRB U30 (3 Ø)		
Indoor unit		HN1600MC NK1				
Space heating (according to EN14825)	Average climate water outlet 35°C	SCOP	4.60	4.57	4.55	
		Seasonal space heating efficiency (η_s)	%	181	180	179
		Seasonal space heating eff. class (A+++ to D scale)	-	A+++	A+++	A+++
	Average climate water outlet 55°C	SCOP	3.50	3.47	3.45	
		Seasonal space heating efficiency (η_s)	%	137	136	135
		Seasonal space heating eff. class (A+++ to D scale)	-	A++	A++	A++

Nominal capacity and nominal power input

Description	OAT ¹⁾ (DB)	LWT ²⁾ (DB)	Outdoor unit	HU121MRB U30 (1 Ø)	HU141MRB U30 (1 Ø)	HU161MRB U30 (1 Ø)	
				HU123MRB U30 (3 Ø)	HU143MRB U30 (3 Ø)	HU163MRB U30 (3 Ø)	
Indoor unit		HN1600MC NK1					
Nominal capacity	Heating	7°C	35°C	kW	12.00	14.00	16.00
		7°C	55°C		11.00	11.50	12.00
	Cooling	2°C	35°C		11.00	12.00	13.80
		35°C	18°C		12.00	14.00	16.00
Nominal power input	Heating	7°C	35°C	kW	2.38	2.86	3.33
		7°C	55°C		3.79	4.04	4.29
		2°C	35°C		3.01	3.31	3.83
	Cooling	35°C	18°C		2.53	3.26	4.00
		35°C	7°C		4.44	5.38	6.40
		7°C	35°C		5.04	4.89	4.80
COP	Heating	7°C	55°C	W/W	2.90	2.85	2.80
		2°C	35°C		3.65	3.63	3.60
EER	Cooling	35°C	18°C	W/W	4.75	4.30	4.00
		35°C	7°C		2.70	2.60	2.50

1) OAT: Outdoor Air Temperature
2) LWT: Leaving Water Temperature

R32 Hydrosplit Hydro Box

Product specification (outdoor unit)

Technical Specification			Unit	HU121MRB U30	HU141MRB U30	HU161MRB U30	HU123MRB U30	HU143MRB U30	HU163MRB U30
Operation range (outdoor temp.)	Heating	Min. - Max.	°C DB	-25 - 35					
	Cooling								
Compressor	Quantity	EA	1						
	Type	-	Hermetic sealed scroll						
Refrigerant	Type	-	R32						
	GWP (Global Warming Potential)	-	675						
	Precharged amount	g	2,100						
Piping connections	Water Circuit	Inlet	mm (inch)	Male PT 1" according to ISO 7-1 (tapered pipe threads)					
		Outlet	mm (inch)	Male PT 1" according to ISO 7-1 (tapered pipe threads)					
Rated water flow rate (at LWT 35°C)			LPM	34.5	40.3	46.0	34.5	40.3	46.0
Sound power level	Heating	Rated	dB(A)	61	62	63	61	62	63
Sound pressure level (at 1m)	Heating	Rated	dB(A)	53	54	55	53	54	55
Dimensions	Unit	W x H x D	mm	950 x 1,380 x 330					
Weight	Unit		kg	91.7					
Exterior	Color / RAL code	-	Warm gray / RAL 7044						
	Voltage, phase, frequency	V, Ø, Hz	220-240, 1, 50			380-415, 3, 50			
Power supply	Rated running current	Heating	A	10.6	12.7	14.8	3.5	4.2	4.9
		Cooling	A	11.2	14.4	17.7	3.7	4.8	5.9
	Recommended circuit breaker	A	40			16			
Wiring connections	Power supply cable (included earth, H07RN-F)	mm ² x cores	6.0 x 3 C			2.5 x 5 C			

Product specification (indoor unit)

Technical specification			Unit	HN1600MC NK1
Operation range (leaving water)	Heating	Min. - Max.	°C DB	15 - 65
	Cooling			5 - 27 (16 - 27) ¹⁾
	DHW			15 - 80 ²⁾
Flow sensor	Measuring range	Min. - Max.	l/min	5 - 80
Water pressure sensor	Measuring range	Min. - Max.	bar(G)	0 - 20
Expansion vessel	Volume		l	8
Safety valve	Pressure limit	Upper limit	bar	3
Piping connections	Water circuit	Outlet to heat load	inch	Male PT 1" according to ISO 7-1 (tapered pipe threads)
		Inlet from heat load		Male PT 1" according to ISO 7-1 (tapered pipe threads)
		Outlet to outdoor unit		Male PT 1" according to ISO 7-1 (tapered pipe threads)
		Inlet from outdoor unit		Male PT 1" according to ISO 7-1 (tapered pipe threads)
Wiring connections	Power and communication cable (included earth, H07RN-F)	mm ² x cores	0.75 x 4 C	
Sound power level	Heating	Rated	dB(A)	44
Dimensions	Unit	W x H x D	mm	490 x 850 x 315
Weight	Unit		kg	30.5
Exterior	Color / RAL code	-	Noble white / RAL 9016	

1) When a fan coil unit is not used.

2) DHW 55 - 80°C operating is available only when the booster heater is operating.

Note

1. Due to our policy of innovation, some specifications may be changed without notification.

2. Wiring cable size must comply with the applicable local and national codes.

Especially the power cable and circuit breaker should be selected in accordance with that.

3. Sound power level is measured on the rated condition in accordance with ISO 9614 standard.

Sound pressure level is converted from sound power level based on a tonality penalty of 0 dB and installation in free-field. The directivity index (Q) is assumed as 2.

Therefore, these values can be increased owing to ambient conditions during operation.

Rated sound power level is in accordance with EN12102-1 under condition of EN14825.

4. Performances are in accordance with EN14511 and reflect ErP testing conditions. Above gives the declared values at rated conditions acc. ErP regulation

• Rated running current: Outdoor Temp. 7°C DB / 6°C WB, LWT 35°C

5. This product contains fluorinated greenhouse gases.

6. All installation sites must be equipped with an earth leakage circuit breaker (ELCB).

Accessory Parts (Optional Accessory)

Backup heater

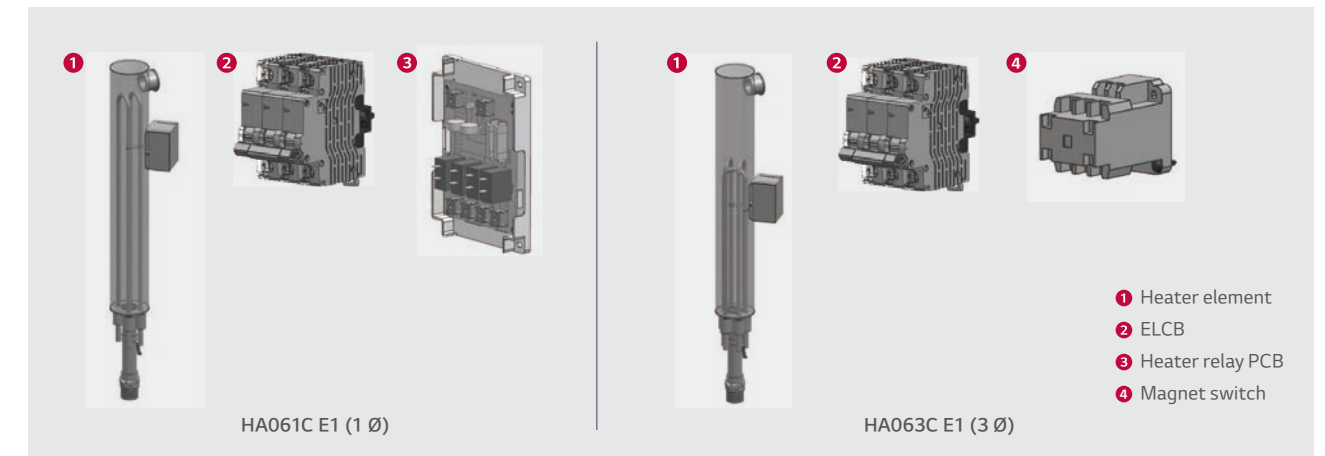

Electrical specification			HA061C E1 (1 Ø)	HA063C E1 (3 Ø)
Backup heater	Type	-	Sheath	
	No. of heating coil	EA	2	3
	Max. power consumption	kW	3.0 + 3.0	2.0 + 2.0 + 2.0
	Heating step	Step	1	1
	Power supply	V, Ø, Hz	220 - 240, 1, 50	380 - 415, 3, 50
	Current (rated)	A	24.0	8.7
	Circuit breaker (ELCB)	A	40	20
Wiring connection	Power cable (included earth, H07RN-F)	mm ² x cores	6.0 x 3 C	2.5 x 5 C

* The backup heater should be purchased and installed separately.

Accessory Parts

Strainer



Technical specification		Details
Material	Body	Brass
	Mesh	Stainless steel (STS304)
Mesh	Mesh no.	30
	Max. particle size	0.6 mm
Piping connection		Female G 1" according to ISO 228-1

* The strainer is supplied with the product, but it needs to be installed separately.

* This strainer should be installed at the inlet connection of the outdoor unit to protect the clogging of a plate heat exchanger.

Performance Table for Heating Operation

Maximum heating capacity (including defrost effect)

HU121MRB U30 / HU123MRB U30 + HN1600MC NK1

Outdoor temperature	LWT 30°C	LWT 35°C	LWT 40°C	LWT 45°C	LWT 50°C	LWT 55°C	LWT 60°C	LWT 65°C
	Capacity (kW)							
-25°C DB	9.66	8.85	8.42	8.29	-	-	-	-
-20°C DB	10.13	10.00	9.88	9.75	9.63	-	-	-
-15°C DB	11.50	11.50	11.50	11.50	11.50	11.50	-	-
-7°C DB	12.00	12.00	12.00	12.00	12.00	12.00	12.00	-
-4°C DB	12.00	12.00	12.00	12.00	12.00	12.00	12.00	12.00
-2°C DB	12.00	12.00	12.00	12.00	12.00	12.00	12.00	12.00
2°C DB	12.00	12.00	12.00	12.00	12.00	12.00	12.00	12.00
7°C DB	12.00	12.00	12.00	12.00	12.00	12.00	12.00	12.00
10°C DB	12.00	12.00	12.00	12.00	12.00	12.00	12.00	12.00
15°C DB	12.00	12.00	12.00	12.00	12.00	12.00	12.00	12.00
18°C DB	12.00	12.00	12.00	12.00	12.00	12.00	12.00	12.00
20°C DB	12.00	12.00	12.00	12.00	12.00	12.00	12.00	12.00
35°C DB	12.00	12.00	12.00	12.00	12.00	12.00	12.00	12.00

HU141MRB U30 / HU143MRB U30 + HN1600MC NK1

Outdoor temperature	LWT 30°C	LWT 35°C	LWT 40°C	LWT 45°C	LWT 50°C	LWT 55°C	LWT 60°C	LWT 65°C
	Capacity (kW)							
-25°C DB	10.04	9.21	8.76	8.62	-	-	-	-
-20°C DB	11.82	11.25	10.95	10.67	10.59	-	-	-
-15°C DB	12.52	12.90	13.26	12.88	12.81	12.63	-	-
-7°C DB	14.00	14.00	14.00	14.00	14.00	14.00	14.00	-
-4°C DB	14.00	14.00	14.00	14.00	14.00	14.00	14.00	14.00
-2°C DB	14.00	14.00	14.00	14.00	14.00	14.00	14.00	14.00
2°C DB	14.00	14.00	14.00	14.00	14.00	14.00	14.00	14.00
7°C DB	14.00	14.00	14.00	14.00	14.00	14.00	14.00	14.00
10°C DB	14.00	14.00	14.00	14.00	14.00	14.00	14.00	14.00
15°C DB	14.00	14.00	14.00	14.00	14.00	14.00	14.00	14.00
18°C DB	14.00	14.00	14.00	14.00	14.00	14.00	14.00	14.00
20°C DB	14.00	14.00	14.00	14.00	14.00	14.00	14.00	14.00
35°C DB	14.00	14.00	14.00	14.00	14.00	14.00	14.00	14.00

HU161MRB U30 / HU163MRB U30 + HN1600MC NK1

Outdoor temperature	LWT 30°C	LWT 35°C	LWT 40°C	LWT 45°C	LWT 50°C	LWT 55°C	LWT 60°C	LWT 65°C
	Capacity (kW)							
-25°C DB	10.98	10.00	9.50	9.33	-	-	-	-
-20°C DB	13.43	12.54	12.03	11.78	11.47	-	-	-
-15°C DB	14.23	14.39	14.50	13.95	13.86	13.12	-	-
-7°C DB	16.00	16.00	16.00	16.00	16.00	16.00	16.00	-
-4°C DB	16.00	16.00	16.00	16.00	16.00	16.00	16.00	16.00
-2°C DB	16.00	16.00	16.00	16.00	16.00	16.00	16.00	16.00
2°C DB	16.00	16.00	16.00	16.00	16.00	16.00	16.00	16.00
7°C DB	16.00	16.00	16.00	16.00	16.00	16.00	16.00	16.00
10°C DB	16.00	16.00	16.00	16.00	16.00	16.00	16.00	16.00
15°C DB	16.00	16.00	16.00	16.00	16.00	16.00	16.00	16.00
18°C DB	16.00	16.00	16.00	16.00	16.00	16.00	16.00	16.00
20°C DB	16.00	16.00	16.00	16.00	16.00	16.00	16.00	16.00
35°C DB	16.00	16.00	16.00	16.00	16.00	16.00	16.00	16.00

Note
 1. DB: Dry Bulb Temperature (°C), LWT: Leaving Water Temperature (°C)
 2. Direct interpolation is permissible. Do not extrapolate.
 3. Measuring procedure follows EN-14511.
 • Rated values are based on standard conditions and can be found on specifications.
 • Above table values may not be matched according to installation conditions. Except for rated values, the performance is not guaranteed.
 • The rating might slightly vary depending on test standards or countries.
 4. The shaded areas are not guaranteed continuous operation.

Performance Table for Cooling Operation

Maximum cooling capacity

HU121MRB U30 / HU123MRB U30 + HN1600MC NK1

Outdoor temperature	LWT 7°C	LWT 10°C	LWT 13°C	LWT 15°C	LWT 18°C	LWT 20°C	LWT 22°C
	Capacity (kW)						
10°C DB	12.00	12.00	12.00	12.00	12.00	12.00	12.00
20°C DB	12.00	12.00	12.00	12.00	12.00	12.00	12.00
30°C DB	12.00	12.00	12.00	12.00	12.00	12.00	12.00
35°C DB	12.00	12.00	12.00	12.00	12.00	12.00	12.00
40°C DB	11.75	12.00	12.00	12.00	12.00	12.00	12.00
45°C DB	11.50	12.00	12.00	12.00	12.00	12.00	12.00

HU141MRB U30 / HU143MRB U30 + HN1600MC NK1

Outdoor temperature	LWT 7°C	LWT 10°C	LWT 13°C	LWT 15°C	LWT 18°C	LWT 20°C	LWT 22°C
	Capacity (kW)						
10°C DB	14.00	14.00	14.00	14.00	14.00	14.00	14.00
20°C DB	14.00	14.00	14.00	14.00	14.00	14.00	14.00
30°C DB	14.00	14.00	14.00	14.00	14.00	14.00	14.00
35°C DB	14.00	14.00	14.00	14.00	14.00	14.00	14.00
40°C DB	13.75	14.00	14.00	14.00	14.00	14.00	14.00
45°C DB	13.50	14.00	14.00	14.00	14.00	14.00	14.00

HU161MRB U30 / HU163MRB U30 + HN1600MC NK1

Outdoor temperature	LWT 7°C	LWT 10°C	LWT 13°C	LWT 15°C	LWT 18°C	LWT 20°C	LWT 22°C
	Capacity (kW)						
10°C DB	16.00	16.00	16.00	16.00	16.00	16.00	16.00
20°C DB	16.00	16.00	16.00	16.00	16.00	16.00	16.00
30°C DB	16.00	16.00	16.00	16.00	16.00	16.00	16.00
35°C DB	16.00	16.00	16.00	16.00	16.00	16.00	16.00
40°C DB	15.75	16.00	16.00	16.00	16.00	16.00	16.00
45°C DB	15.50	16.00	16.00	16.00	16.00	16.00	16.00

Note
 1. DB: Dry Bulb Temperature (°C), LWT: Leaving Water Temperature (°C)
 2. Direct interpolation is permissible. Do not extrapolate.
 3. Measuring procedure follows EN-14511.
 • Rated values are based on standard conditions and can be found on specifications.
 • Above table values may not be matched according to installation conditions. Except for rated values, the performance is not guaranteed.
 • The rating might slightly vary depending on test standards or countries.
 4. The shaded areas are not guaranteed continuous operation.

Drawings

Category	Unit	Model name		
		Capacity (kW)		
		12.0	14.0	16.0
1 Phase model 220 - 240 V, 1 Ø, 50 Hz	Outdoor unit	HU121MRB U30	HU141MRB U30	HU161MRB U30
	Indoor unit		HN1600MC NK1	
3 Phase model 380 - 415 V, 3 Ø, 50 Hz	Outdoor unit	HU123MRB U30	HU143MRB U30	HU163MRB U30
	Indoor unit		HN1600MC NK1	

HU121MRB U30 / HU141MRB U30 / HU161MRB U30
HU123MRB U30 / HU143MRB U30 / HU163MRB U30

[Unit: mm]

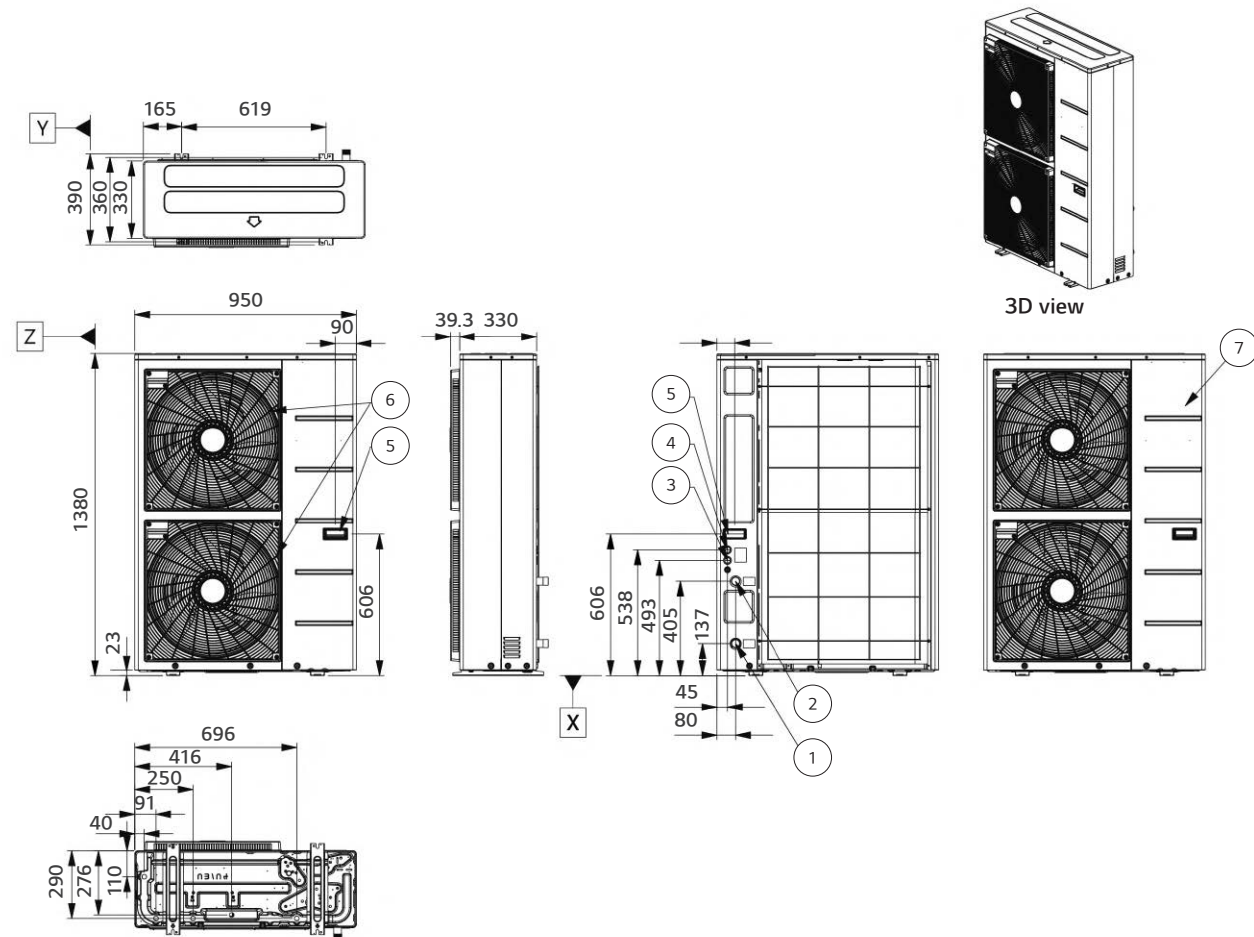

No.	Part name	Description
1	Entering water pipe	Male PT 1" according to ISO 7-1 (tapered pipe threads)
2	Leaving water pipe	Male PT 1" according to ISO 7-1 (tapered pipe threads)
3	Unit power	Power cable hole
4	Low voltage	Communication cable hole
5	Handle	-
6	Air outlet	-
7	Side panel	-

HN1600MC NK1

External

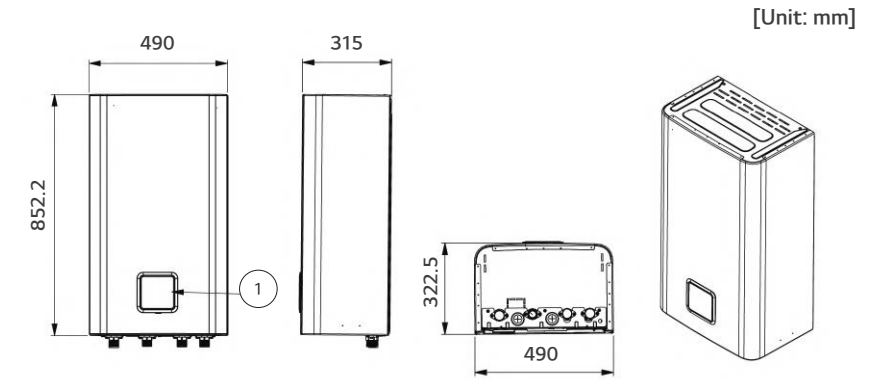

[Unit: mm]

No.	Part name	Description
1	Control panel	Built-in remote controller

Internal

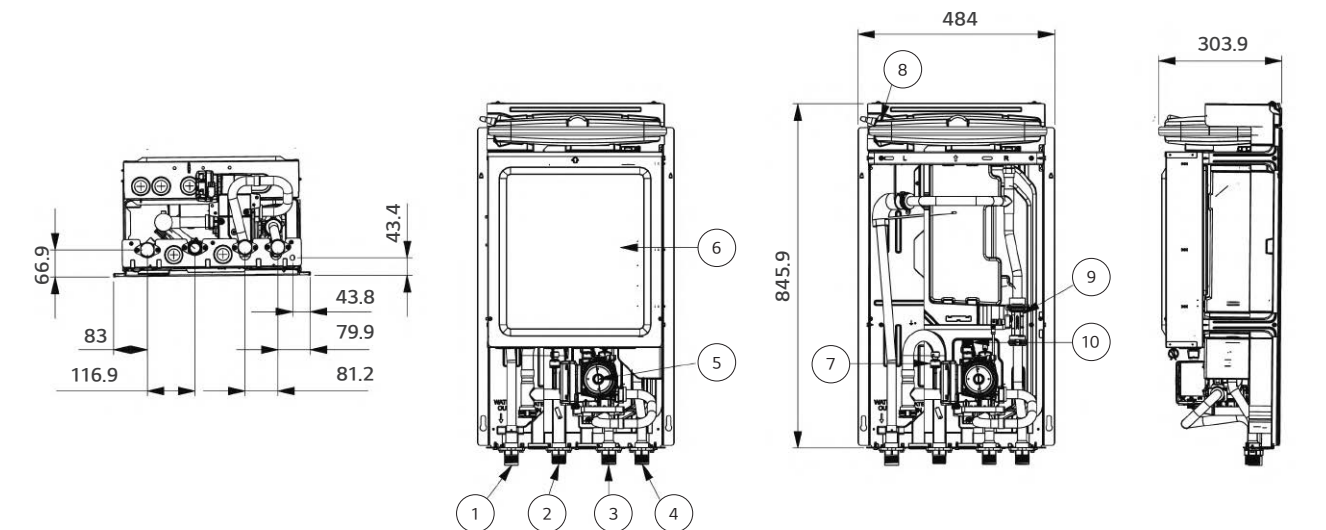

No.	Part name	Description
1	Heating circuit outlet pipe	Male PT 1" according to ISO 7-1 (tapered pipe threads)
2	Heating circuit inlet pipe	Male PT 1" according to ISO 7-1 (tapered pipe threads)
3	Outlet pipe to outdoor unit	Male PT 1" according to ISO 7-1 (tapered pipe threads)
4	Inlet pipe to outdoor unit	Male PT 1" according to ISO 7-1 (tapered pipe threads)
5	Water pump	To circulate water inside the system
6	Control box	PCB and Terminal blocks
7	Pressure sensor	To measure the water pressure (0-2MPa)
8	Expansion tank	8 Liter, 3/4" connection
9	Flow sensor	To measure the water flow rate (5-80 LPM)
10	Safety valve	Open at water pressure 3 bar



THERMA V™ R32

R32 HYDROSPLIT IWT

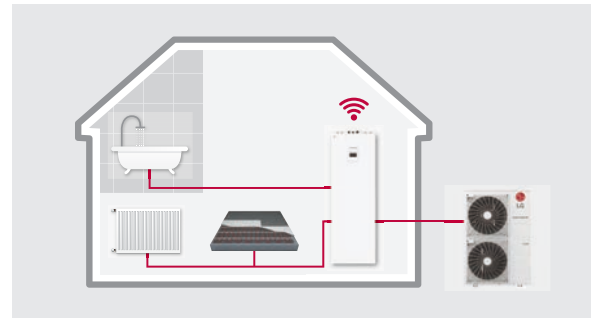
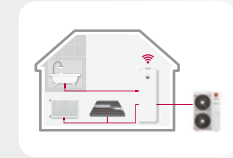

Energy Label

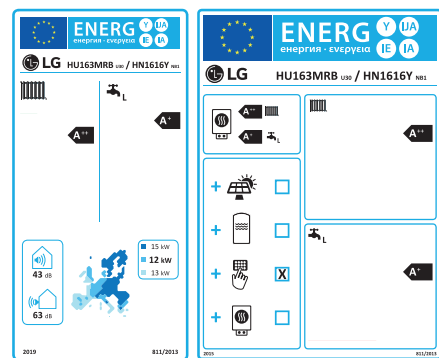

* 16 kW 3 Ø model.
* A+++ to D scale.

Excellent performance & efficiency



User convenience

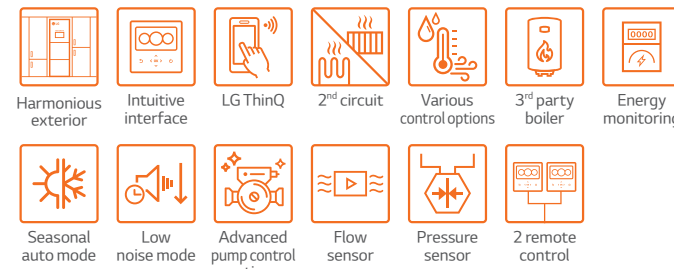

Easy installation & maintenance

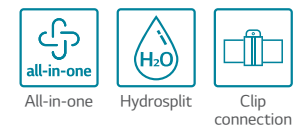

* Detailed description for each function is presented on page 44 – 54.

R32 Hydrosplit IWT Introduction

Therma V R32 Hydrosplit IWT is the perfect space-saving solution for heating, cooling and hot water supply due to its fully integrated hot water tank. This all-in-one solution's hydronic and domestic hot water components are pre-wired, reducing installation time and space occupancy, making it perfect for new builds.

Key Components

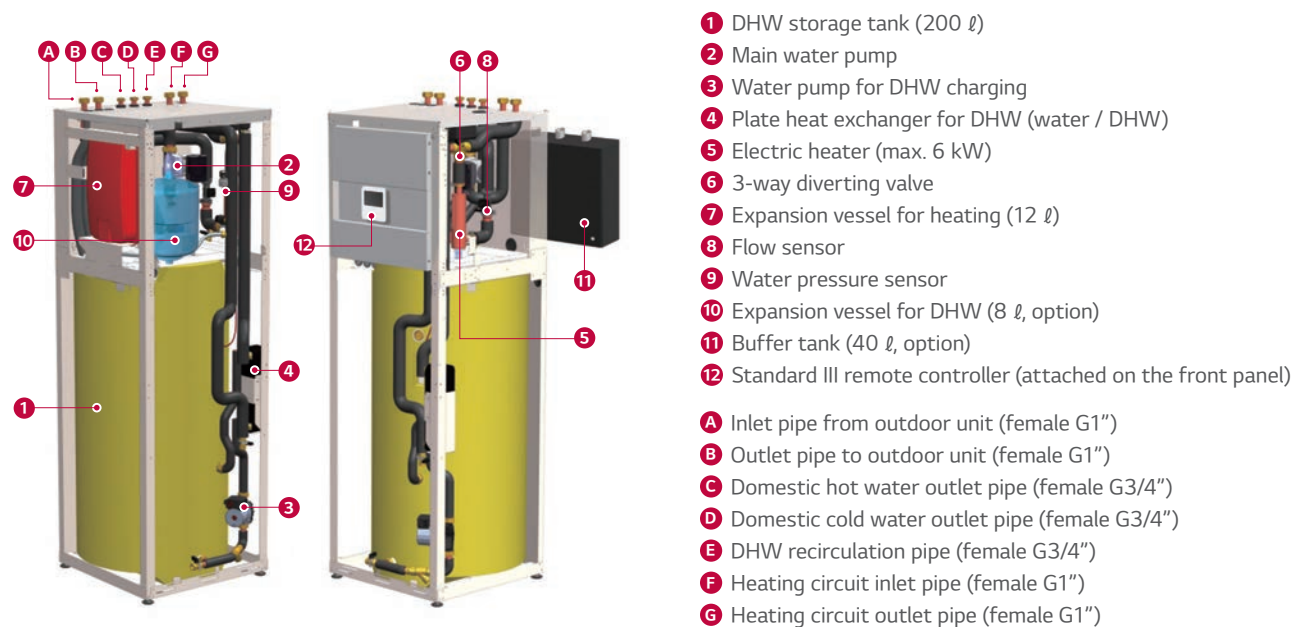

Hydrosplit Concept

The Therma V R32 Hydrosplit IWT connects an IDU and ODU by water pipes due to the heat exchanger's location in the outdoor unit, thus reducing the risk of indoor refrigerant leakage.



Sophisticated and Harmonious Exterior

Varied installation options due to a small, wall-mounted indoor unit, which can be easily connected to an existing third-party water tank. The indoor unit's sleek design fits into diverse indoor spaces, such as a utility or laundry room, a garage or a kitchen.

Save Space and Time

Unlike in the case of a conventional system, this all-in-one solution requires reduced installation time and saves valuable living space.

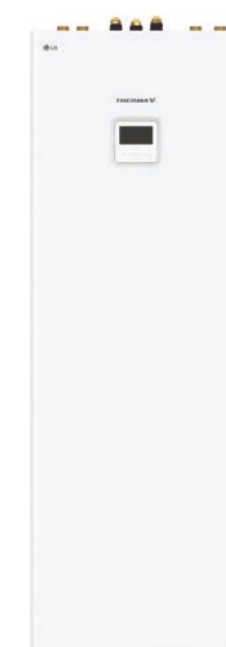

All in one

- Small footprint for product installation
- Quick & easy installation
- DHW tank (200 ℓ) & hydronic component integration
- Integrated max. 6 kW back up heater
- Integrated expansion tank for heating (12 ℓ)
- Integrated buffer tank (40 ℓ) & expansion tank for DHW circuit (8 ℓ) (optional)

R32 Hydrosplit IWT (Integrated Water Tank)



Indoor unit

HN1616Y NB1

Outdoor unit

HN121MRB U30 / HU123MRB U30

HN141MRB U30 / HU143MRB U30

HN161MRB U30 / HU163MRB U30

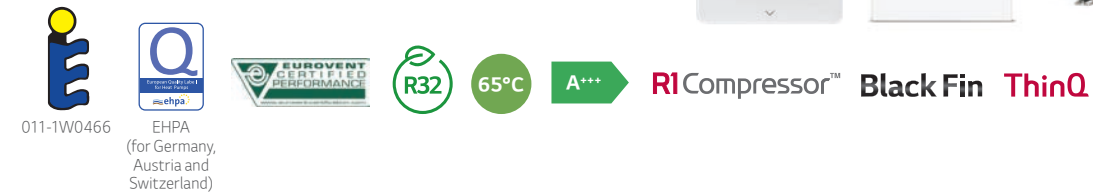

Features

- Water pipes connect IDU & ODU
- SCOP up to 4.60 (average climate / low temp. application): **A+++**
- SCOP up to 3.50 (average climate / mid temp. application): **A++**
- COP_{DHW} 2.74 (water heating efficiency 120 %, profile L): **A+**
- COP up to 5.04 (outdoor air 7°C / leaving water 35°C)
- DHW tank (200 ℓ) & hydronic component integration
- Integrable buffer tank (40 ℓ) & expansion tank for DHW circuit (8 ℓ) (optional)
- 100 % heating capacity at -7°C OAT (@ LWT 35°C)
- Wide operation range (ambient: -25 ~ 35°C / water side: 15 ~ 65°C)
- Built-in water flow & pressure sensors to monitor real-time water circuit
- R32 refrigerant with reduced Global Warming Potential (GWP)
- R1 Compressor
- Black Fin heat exchanger
- LG ThinQ
- Keymark / EHPA (for Germany, Austria and Switzerland) / Eurovent certification

* Only the outdoor units are registered in EHPA certification.

Model line-up

Category	Unit	Model name		
		Capacity (kW)		
		12.0	14.0	16.0
1 Phase model 220 - 240 V, 1 Ø, 50 Hz	Outdoor unit	HU121MRB U30	HU141MRB U30	HU161MRB U30
	Indoor unit	HN1616Y NB1		
3 Phase model 380 - 415 V, 3 Ø, 50 Hz	Outdoor unit	HU123MRB U30	HU143MRB U30	HU163MRB U30
	Indoor unit	HN1616Y NB1		

Seasonal energy

Description		Outdoor unit	HU121MRB U30 (1 Ø)	HU141MRB U30 (1 Ø)	HU161MRB U30 (1 Ø)		
			HU123MRB U30 (3 Ø)	HU143MRB U30 (3 Ø)	HU163MRB U30 (3 Ø)		
		Indoor unit	HN1616Y NB1				
Space heating (according to EN14825)	Average climate water outlet 35°C	SCOP	-	4.60	4.57	4.55	
		Seasonal space heating efficiency (η _s)	%	181	180	179	
		Seasonal space heating eff. class (A+++ to D scale)	-	A+++	A+++	A+++	
	Average climate water outlet 55°C	SCOP	-	3.50	3.47	3.45	
		Seasonal space heating efficiency (η _s)	%	137	136	135	
		Seasonal space heating eff. class (A+++ to D scale)	-	A++	A++	A++	
Domestic hot water efficiency (according to EN16147)	Average climate	Declared load profile	-	L	L	L	
		Water heating efficiency (η _{WH})	%	120	120	120	
		COP _{DHW}	-	2.74	2.74	2.74	
		Water heating eff. class	-	A+	A+	A+	
		Warmer climate	Declared load Profile	-	L	L	L
			Water heating efficiency (η _{WH})	%	151	151	151
	COP _{DHW}		-	3.43	3.43	3.43	
	Water heating eff. class		-	A++	A++	A++	
	Colder climate		Declared load profile	-	L	L	L
			Water heating efficiency (η _{WH})	%	101	101	101
		COP _{DHW}	-	2.34	2.34	2.34	
		Water heating eff. class	-	A	A	A	

Nominal capacity and nominal power input

Description		OAT ¹⁾ (DB)	LWT ²⁾ (DB)	Outdoor unit	HU121MRB U30 (1 Ø)	HU141MRB U30 (1 Ø)	HU161MRB U30 (1 Ø)
					HU123MRB U30 (3 Ø)	HU143MRB U30 (3 Ø)	HU163MRB U30 (3 Ø)
				Indoor unit	HN1616Y NB1		
Nominal capacity	Heating	7°C	35°C	kW	12.00	14.00	16.00
			55°C		11.00	11.50	12.00
		2°C	35°C		11.00	12.00	13.80
	Cooling	35°C	18°C		12.00	14.00	16.00
			7°C		12.00	14.00	16.00
		7°C	35°C		2.38	2.86	3.33
Nominal power input	Heating	7°C	55°C	kW	3.79	4.04	4.29
			35°C		3.01	3.31	3.83
		2°C	35°C		2.53	3.26	4.00
	Cooling	35°C	18°C		4.44	5.38	6.40
			7°C		5.04	4.89	4.80
		7°C	55°C		2.90	2.85	2.80
COP	Heating	7°C	55°C	W/W	3.65	3.63	3.60
			35°C		4.75	4.30	4.00
		2°C	35°C		2.70	2.60	2.50

1) OAT: Outdoor Air Temperature
2) LWT: Leaving Water Temperature

R32 Hydrosplit IWT (Integrated Water Tank)

Product specification (outdoor unit)

Technical Specification			Unit	HU121MRB U30	HU141MRB U30	HU161MRB U30	HU123MRB U30	HU143MRB U30	HU163MRB U30
Operation range (outdoor temp.)	Heating	Min. - Max.	°C DB	-25 - 35					
	Cooling								
Compressor	Quantity	EA							
	Type	Hermetic sealed scroll							
Refrigerant	Type	R32							
	GWP (Global Warming Potential)	675							
	Precharged amount	g							
	t-CO ₂ eq	1.418							
Piping connections	Water circuit	Inlet	mm (inch)						
		Outlet	Male PT 1" according to ISO 7-1 (tapered pipe threads)						
Rated water flow rate (at LWT 35°C)			LPM	34.5	40.3	46.0	34.5	40.3	46.0
Sound power level	Heating	Rated	dB(A)	61	62	63	61	62	63
	Cooling	Rated		53	54	55	53	54	55
Dimensions	Unit	W x H x D	mm						
	Weight	kg							
Exterior	Color / RAL code		Warm gray / RAL 7044						
	Voltage, phase, frequency		V, Ø, Hz	220-240, 1, 50			380-415, 3, 50		
Power supply	Rated running current	Heating	A	10.6	12.7	14.8	3.5	4.2	4.9
		Cooling	A	11.2	14.4	17.7	3.7	4.8	5.9
	Recommended circuit breaker	A	40						
Wiring connections	Power supply cable (included earth, H07RN-F)		mm ² x cores	6.0 x 3 C			2.5 x 5 C		

Product specification (indoor unit)

Technical Specification			Unit	HN1616Y NB1
Operation range (leaving water temperature)	Heating	Min. - Max.	°C DB	15 - 65
	Cooling			5 - 27 (16 - 27) ¹⁾
Domestic hot water tank	Volume	ℓ		
	Internal thermal protect limit	°C		
Flow sensor	Measuring range	Min. - Max.	LPM	5 - 80
Water pressure sensor	Measuring range	Min. - Max.	bar(G)	0 - 20
Expansion vessel (heating circuit)	Volume	ℓ		
Safety valve	Heating circuit	Upper limit	bar	3
	DHW circuit	Upper limit	bar	10
Electric heater (Case 1 / Case 2 / Case 3) ³⁾	Type	-		
	Number of heating coil	EA		
	Capacity combination	kW		
	Heating step	Step		
	Power supply	V, Ø, Hz	220-240, 1, 50 / 220-240, 1, 50 / 380-415, 3, 50	
Wiring connections	Power supply cable (included earth, H07RN-F)		mm ² x cores	4.0 x 3 C / 4.0 x 3 C / 2.5 x 5 C
	Rated running current		A	8.7 / 17.4 / 8.7
Piping connections	Water circuit	Inlet	inch	Female G 1" according to ISO 228-1 (parallel pipe threads)
		Outlet	inch	
		Inlet from outdoor unit	inch	
	DHW tank water circuit	Outlet to outdoor unit	inch	
		Cold inlet	inch	
Recirculation	Hot outlet	inch	Female G 3/4" according to ISO 228-1 (parallel pipe threads)	
	Recirculation	inch		
Wiring connections	Power and communication cable (included earth, H07RN-F)		mm ² x cores	0.75 x 4 C
Sound power level	Heating	Rated	dB(A)	43
Dimensions	Unit	W x H x D	mm	601 x 1,812 x 685
Weight	Unit	kg		
Exterior	Color / RAL code		-	

1) When a fan coil unit is not used.
 2) DHW 55 - 80°C Operating is available only when the electric heater is operating.
 3) The capacity of electric heater can be adjusted by wiring.

Note

- Due to our policy of innovation, some specifications may be changed without notification.
- Wiring cable size must comply with the applicable local and national codes. Especially the power cable and circuit breaker should be selected in accordance with that.
- Sound power level is measured on the rated condition in accordance with ISO 9614 standard. Sound pressure level is converted from sound power level based on a tonality penalty of 0 dB and installation in free-field. The directivity index (Q) is assumed as 2. Therefore, these values can be increased owing to ambient conditions during operation. Rated sound power level is in accordance with EN12102-1 under condition of EN14825.
- Performances are in accordance with EN14511 and reflect ErP testing conditions. Above gives the declared values at rated conditions acc. ErP regulation.
 - * Rated running current: Outdoor Temp. 7°C DB / 6°C WB, LWT 35°C
- This product contains fluorinated greenhouse gases.
- All installation sites must be equipped with an earth leakage circuit breaker (ELCB).

Accessory Parts (Optional Accessory)

Buffer tank for space heating



A standard 40 ℓ buffer tank for can be installed as an optional accessory for space heating. Fitting seamlessly into the main casing, it can be attached to the backside of the indoor unit.

Buffer tank for space heating		Unit	OSHB-40KT.AEU
Water volume		ℓ	40
Dimensions (W x H x D)		mm	518 x 560 x 175
Weight (w/o water)	Product	kg	24

* The buffer tank for space heating should be purchased and installed separately.

Expansion vessel for DHW



A standard 8 ℓ DHW expansion vessel, that conveniently fits inside the indoor unit, can be installed as an optional accessory. It is provided with an accessory kit that includes a flexible connection tube.

Expansion vessel for DHW		Unit	OSHE-12KT.AEU
Expansion volume		ℓ	8
Connection		inch	3/4
Max. pressure		bar	10
Pre-charge		bar	3
Dimensions (W x H x D)		mm	416 x 238 x 502
Weight (w/o water)	Product	kg	2.5

* The expansion vessel for DHW should be purchased and installed separately.

Accessory Parts

Shut-off valve



Shut-off valve with strainer



Strainer



Technical specification		Details
Material	Body	Brass
	Mesh	Stainless steel (STS304)
Mesh	Mesh no.	30
	Max. particle size	0.6 mm
Piping connection		Female G 1" according to ISO 228-1

* The strainer and valves are supplied with the product, but it need to be installed separately.

* This strainer should be installed at the inlet connection of the outdoor unit to protect the clogging of a plate heat exchanger.

Performance Table for Heating Operation

Maximum heating capacity (including defrost effect)

HU121MRB U30 / HU123MRB U30 + HN1616Y NB1

Outdoor temperature	LWT 30°C	LWT 35°C	LWT 40°C	LWT 45°C	LWT 50°C	LWT 55°C	LWT 60°C	LWT 65°C
	Capacity (kW)							
-25°C DB	9.66	8.85	8.42	8.29	-	-	-	-
-20°C DB	10.13	10.00	9.88	9.75	9.63	-	-	-
-15°C DB	11.50	11.50	11.50	11.50	11.50	11.50	-	-
-7°C DB	12.00	12.00	12.00	12.00	12.00	12.00	12.00	-
-4°C DB	12.00	12.00	12.00	12.00	12.00	12.00	12.00	12.00
-2°C DB	12.00	12.00	12.00	12.00	12.00	12.00	12.00	12.00
2°C DB	12.00	12.00	12.00	12.00	12.00	12.00	12.00	12.00
7°C DB	12.00	12.00	12.00	12.00	12.00	12.00	12.00	12.00
10°C DB	12.00	12.00	12.00	12.00	12.00	12.00	12.00	12.00
15°C DB	12.00	12.00	12.00	12.00	12.00	12.00	12.00	12.00
18°C DB	12.00	12.00	12.00	12.00	12.00	12.00	12.00	12.00
20°C DB	12.00	12.00	12.00	12.00	12.00	12.00	12.00	12.00
35°C DB	12.00	12.00	12.00	12.00	12.00	12.00	12.00	12.00

HU141MRB U30 / HU143MRB U30 + HN1616Y NB1

Outdoor temperature	LWT 30°C	LWT 35°C	LWT 40°C	LWT 45°C	LWT 50°C	LWT 55°C	LWT 60°C	LWT 65°C
	Capacity (kW)							
-25°C DB	10.04	9.21	8.76	8.62	-	-	-	-
-20°C DB	11.82	11.25	10.95	10.67	10.59	-	-	-
-15°C DB	12.52	12.90	13.26	12.88	12.81	12.63	-	-
-7°C DB	14.00	14.00	14.00	14.00	14.00	14.00	14.00	-
-4°C DB	14.00	14.00	14.00	14.00	14.00	14.00	14.00	14.00
-2°C DB	14.00	14.00	14.00	14.00	14.00	14.00	14.00	14.00
2°C DB	14.00	14.00	14.00	14.00	14.00	14.00	14.00	14.00
7°C DB	14.00	14.00	14.00	14.00	14.00	14.00	14.00	14.00
10°C DB	14.00	14.00	14.00	14.00	14.00	14.00	14.00	14.00
15°C DB	14.00	14.00	14.00	14.00	14.00	14.00	14.00	14.00
18°C DB	14.00	14.00	14.00	14.00	14.00	14.00	14.00	14.00
20°C DB	14.00	14.00	14.00	14.00	14.00	14.00	14.00	14.00
35°C DB	14.00	14.00	14.00	14.00	14.00	14.00	14.00	14.00

HU161MRB U30 / HU163MRB U30 + HN1616Y NB1

Outdoor temperature	LWT 30°C	LWT 35°C	LWT 40°C	LWT 45°C	LWT 50°C	LWT 55°C	LWT 60°C	LWT 65°C
	Capacity (kW)							
-25°C DB	10.98	10.00	9.50	9.33	-	-	-	-
-20°C DB	13.43	12.54	12.03	11.78	11.47	-	-	-
-15°C DB	14.23	14.39	14.50	13.95	13.86	13.12	-	-
-7°C DB	16.00	16.00	16.00	16.00	16.00	16.00	16.00	-
-4°C DB	16.00	16.00	16.00	16.00	16.00	16.00	16.00	16.00
-2°C DB	16.00	16.00	16.00	16.00	16.00	16.00	16.00	16.00
2°C DB	16.00	16.00	16.00	16.00	16.00	16.00	16.00	16.00
7°C DB	16.00	16.00	16.00	16.00	16.00	16.00	16.00	16.00
10°C DB	16.00	16.00	16.00	16.00	16.00	16.00	16.00	16.00
15°C DB	16.00	16.00	16.00	16.00	16.00	16.00	16.00	16.00
18°C DB	16.00	16.00	16.00	16.00	16.00	16.00	16.00	16.00
20°C DB	16.00	16.00	16.00	16.00	16.00	16.00	16.00	16.00
35°C DB	16.00	16.00	16.00	16.00	16.00	16.00	16.00	16.00

Note
 1. DB: Dry Bulb Temperature (°C), LWT: Leaving Water Temperature (°C)
 2. Direct interpolation is permissible. Do not extrapolate.
 3. Measuring procedure follows EN-14511.
 • Rated values are based on standard conditions and can be found on specifications.
 • Above table values may not be matched according to installation conditions. Except for rated values, the performance is not guaranteed.
 • The rating might slightly vary depending on test standards or countries.
 4. The shaded areas are not guaranteed continuous operation.

Performance Table for Cooling Operation

Maximum cooling capacity

HU121MRB U30 / HU123MRB U30 + HN1616Y NB1

Outdoor temperature	LWT 7°C	LWT 10°C	LWT 13°C	LWT 15°C	LWT 18°C	LWT 20°C	LWT 22°C
	Capacity (kW)						
10°C DB	12.00	12.00	12.00	12.00	12.00	12.00	12.00
20°C DB	12.00	12.00	12.00	12.00	12.00	12.00	12.00
30°C DB	12.00	12.00	12.00	12.00	12.00	12.00	12.00
35°C DB	12.00	12.00	12.00	12.00	12.00	12.00	12.00
40°C DB	11.75	12.00	12.00	12.00	12.00	12.00	12.00
45°C DB	11.50	12.00	12.00	12.00	12.00	12.00	12.00

HU141MRB U30 / HU143MRB U30 + HN1616Y NB1

Outdoor temperature	LWT 7°C	LWT 10°C	LWT 13°C	LWT 15°C	LWT 18°C	LWT 20°C	LWT 22°C
	Capacity (kW)						
10°C DB	14.00	14.00	14.00	14.00	14.00	14.00	14.00
20°C DB	14.00	14.00	14.00	14.00	14.00	14.00	14.00
30°C DB	14.00	14.00	14.00	14.00	14.00	14.00	14.00
35°C DB	14.00	14.00	14.00	14.00	14.00	14.00	14.00
40°C DB	13.75	14.00	14.00	14.00	14.00	14.00	14.00
45°C DB	13.50	14.00	14.00	14.00	14.00	14.00	14.00

HU161MRB U30 / HU163MRB U30 + HN1616Y NB1

Outdoor temperature	LWT 7°C	LWT 10°C	LWT 13°C	LWT 15°C	LWT 18°C	LWT 20°C	LWT 22°C
	Capacity (kW)						
10°C DB	16.00	16.00	16.00	16.00	16.00	16.00	16.00
20°C DB	16.00	16.00	16.00	16.00	16.00	16.00	16.00
30°C DB	16.00	16.00	16.00	16.00	16.00	16.00	16.00
35°C DB	16.00	16.00	16.00	16.00	16.00	16.00	16.00
40°C DB	15.75	16.00	16.00	16.00	16.00	16.00	16.00
45°C DB	15.50	16.00	16.00	16.00	16.00	16.00	16.00

Note
 1. DB: Dry Bulb Temperature (°C), LWT: Leaving Water Temperature (°C)
 2. Direct interpolation is permissible. Do not extrapolate.
 3. Measuring procedure follows EN-14511.
 • Rated values are based on standard conditions and can be found on specifications.
 • Above table values may not be matched according to installation conditions. Except for rated values, the performance is not guaranteed.
 • The rating might slightly vary depending on test standards or countries.
 4. The shaded areas are not guaranteed continuous operation.

Drawings

Category	Unit	Model name		
		Capacity (kW)		
		12.0	14.0	16.0
1 Phase model 220 - 240 V, 1 Ø, 50 Hz	Outdoor unit	HU121MRB U30	HU141MRB U30	HU161MRB U30
	Indoor unit		HN1616Y NB1	
3 Phase model 380 - 415 V, 3 Ø, 50 Hz	Outdoor unit	HU123MRB U30	HU143MRB U30	HU163MRB U30
	Indoor unit		HN1616Y NB1	

HU121MRB U30 / HU141MRB U30 / HU161MRB U30
HU123MRB U30 / HU143MRB U30 / HU163MRB U30

[Unit: mm]

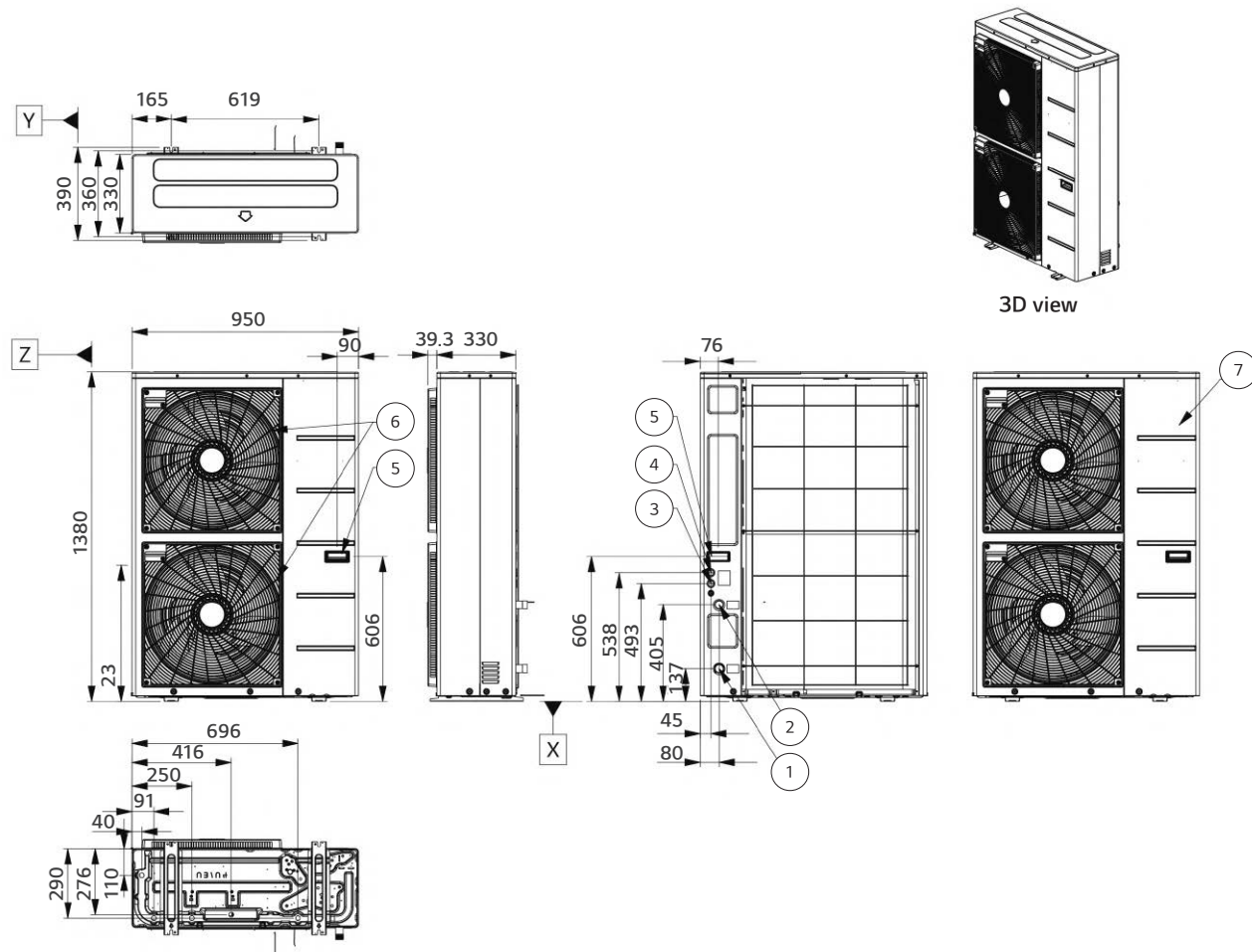

No.	Part name	Description
1	Entering water pipe	Male PT 1" according to ISO 7-1 (tapered pipe threads)
2	Leaving water pipe	Male PT 1" according to ISO 7-1 (tapered pipe threads)
3	Unit power	Power cable hole
4	Low voltage	Communication cable hole
5	Handle	-
6	Air outlet	-
7	Side panel	-

HN1616Y NB1

[Unit: mm]

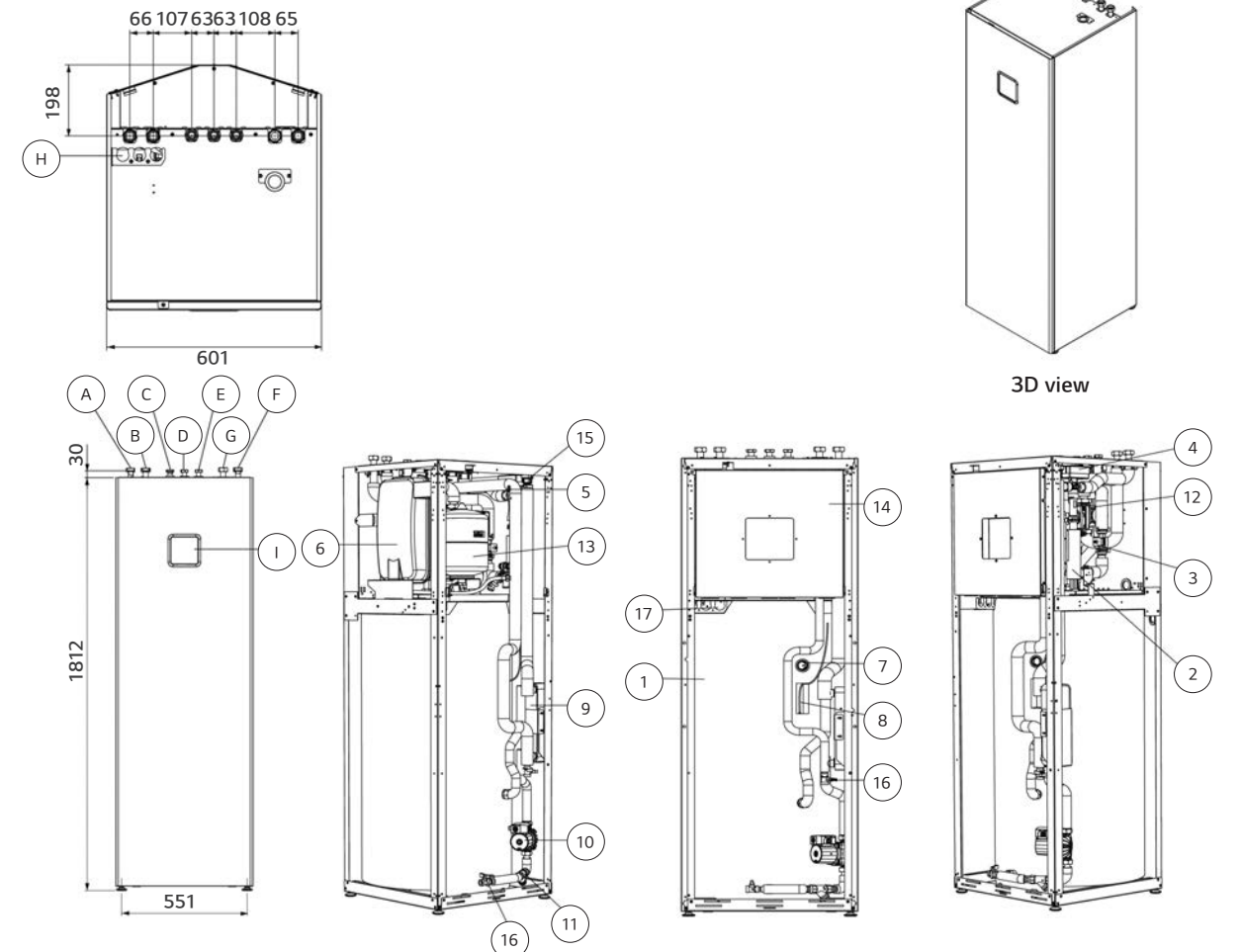

No.	Part name	Description
1	Domestic hot water tank	200 ℓ
2	Electric heater	Max 6 kW
3	Flow sensor	To measure the water flow rate (5-80 LPM)
4	3 way valve	Heating / DHW circuit
5	Water pressure sensor	To measure the water pressure (0-2 MPa)
6	Expansion vessel	12 ℓ for heating circuit
7	Magnesium anode	To prevent corrosion
8	DHW tank sensor	Temperature sensor
9	Plate heat exchanger	Heat exchange (water / DHW tank)
10	DHW water pump	To circulate water for DHW heating
11	Strainer for DHW tank	Filtering and stacking particles
12	Main water pump	To circulate water inside the system
13	Expansion vessel	8 ℓ For DHW circuit (accessory)
14	Control box	PCB and terminal blocks
15	Air vent	Air purging when charging water
16	Drain cock	Valve for water draining
17	Electrical conduits	For electric wiring

No.	Part name	Part name
A	Inlet pipe from outdoor unit	Female G1"
B	Outlet pipe to outdoor unit	Female G1"
C	Domestic hot water outlet pipe	Female G3/4"
D	Domestic cold water inlet pipe	Female G3/4"
E	Domestic re-circulation pipe	Female G3/4"
F	Heating circuit inlet pipe	Female G1"
G	Heating circuit outlet pipe	Female G1"
H	Electrical conduits	For electric wiring
I	Control panel	Built-in remote controller



THERMA V™ R32

R32 SPLIT 4/6 kW HYDRO BOX

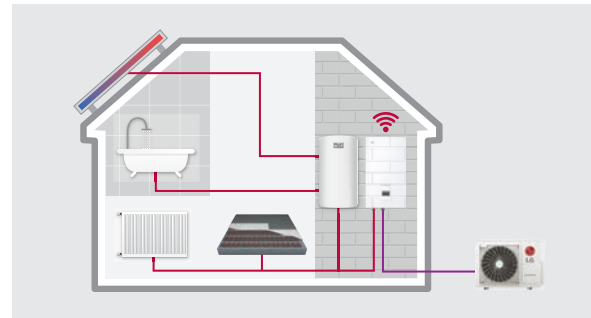

Excellent performance & efficiency

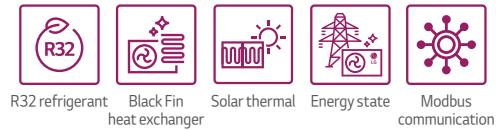

User convenience

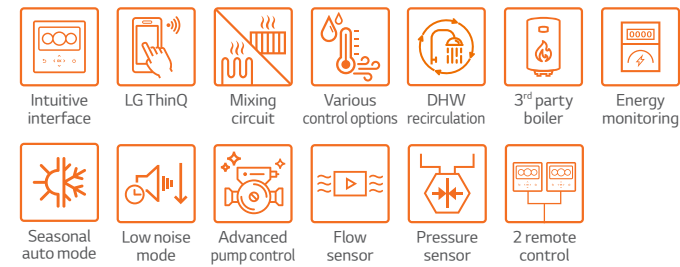

Easy installation & maintenance

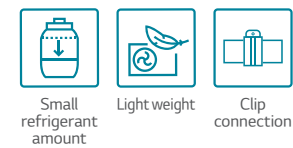

Energy Label

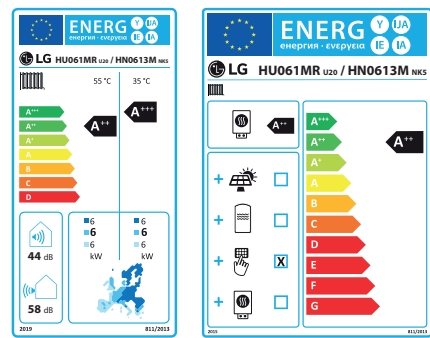

* 6 kW 1 Ø model.
* A+++ to D scale.

R32 Split Hydro Box Introduction

The LG Therma V R32 Split Hydro Box is a hydro box type system consisting of an indoor hydro box unit and an outdoor unit. The two units are connected by refrigerant piping only, thus hydronic components such as plate heat exchanger, expansion tank and water pump are located within the indoor unit. Due to the split nature, freezing will not compromise this unit regardless of outdoor ambient temperatures. The outdoor unit is on offer in 4/6 kW and 5/7/9 kW capacity range and R32 Split 4/6 kW model is suitable for new build houses that are well insulated and require a small heating load.

Key Components

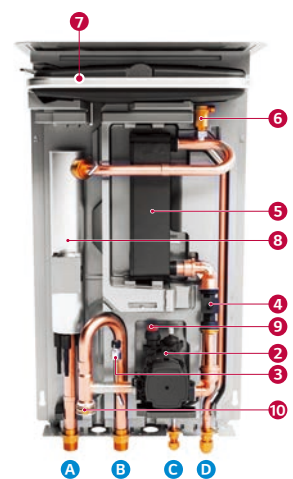

Components

- 1 Standard III remote controller (attached on the front panel)
- 2 Water pump
- 3 Water pressure sensor
- 4 Flow sensor
- 5 Plate type heat exchanger (ref/water)
- 6 Air vent valve
- 7 Expansion vessel (8 l)
- 8 Back up electric heater (3 kW)
- 9 Safety valve
- 10 Strainer

Connections

- A Heating circuit outlet pipe (male PT 1" *)
- B Heating circuit inlet pipe (male PT 1" *)
- C Refrigerant liquid pipe (SAE 1/4" with connector **)
- D Refrigerant gas pipe (SAE 1/2" with connector **)

* According to ISO 7-1 (tapered pipe threads)

** In case of Split 4/6 kW model, the adaptors provided with the outdoor unit must be separately installed on the gas/liquid connection of the indoor unit when connecting the refrigerant pipe. After installing the adaptors, the liquid and gas connection size becomes Ø 6.35 (1/4 inch) and Ø 12.7 (1/2 inch) respectively.

Small Refrigerant Amount - free from minimum floor area requirements due to R32 refrigerant

Minimum floor space requirements do not apply to R32 Split 4/6 kW, as the maximum refrigerant amount (including 30 m pipes) used in the product is smaller than the minimum set by regulation. As a result, there are more opportunities for flexible design and installation.

Max. refrigerant amount
Considering the maximum allowable piping distance of 30 m
→ No room size restriction

Min. regulated refrigerant amount
As per IEC 60335-2-40 6th edition

Reduced Noise Level

The R32 Split outdoor unit can be installed at the minimum of 4.5 m away¹⁾ from neighboring houses while complying with noise-related requirements in most European countries, including Germany. (based on 4 kW ODU & low noise mode)

Description	Germany	Austria	Switzerland	Netherlands
Sound pressure threshold	Day time	50 dB (A) (06:00 - 22:00)	40 dB (A) (06:00 - 19:00)	45 dB (A) (07:00 - 19:00)
	Evening	-	35 dB (A) (19:00 - 22:00)	-
	Night time	35 dB (A) (22:00 - 06:00)	30 dB (A) (22:00 - 06:00)	35 dB (A) (19:00 - 07:00)

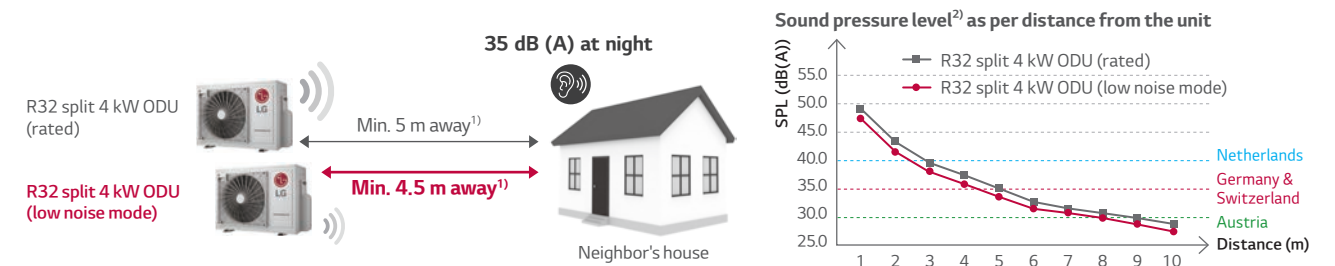

1) Minimum distance to be away from a neighboring property may vary depending on installation conditions and noise regulations in individual countries.
2) Sound pressure level is converted from sound power level of low noise mode based on a tonality penalty of 0 dB and installation in free-field. The directivity index (Q) is assumed as 2.

R32 Split 4/6 kW Hydro Box



Indoor unit
HN0613M NK5
Outdoor unit
HU041MR U20
HU061MR U20



011-1W0567
* MCS and EHPA label under development

Features

- Answers the needs of new build houses with good insulation and a small heating demand
- Demonstrates a lower noise level (sound pressure level at 3 m: 39 dB (A) for 4 kW / 40 dB (A) for 6 kW)
- Enhanced installation flexibility**
 - Free from minimum floor area requirements due to R32 refrigerant (Max. refrigerant amount (including 30 m pipes) < 1.842 kg)
 - Light weight and compact size
 - Max. 30 m refrigerant piping
 - Integrated 3 kW backup heater and expansion tank for heating (8 ℓ)

- High efficiency & operational range**
 - SCOP up to 4.65 / 3.23 (low temp. / mid temp. application): A++ / A+
 - COP up to 5.10 (outdoor air 7°C / leaving water 35°C)
 - Operation range (ambient: -20 ~ 35°C / water side: 15 ~ 55°C)
- Innovative design & technology**
 - Energy monitoring of estimated power consumption
- Control & connectivity**
 - LG ThinQ Wi-Fi control and monitoring solution
 - PV / ESS or smart grid connectivity

Model line-up

Category	Unit	Model name	
		Capacity (kW)	
		4.0	6.0
1 Phase model 220 - 240 V, 1 Ø, 50 Hz	Outdoor unit	HU041MR U20	HU061MR U20
	Indoor unit	HN0613M NK5	

Seasonal energy

Description		Outdoor unit	HU041MR U20	HU061MR U20
Space heating (according to EN14825)	Average climate water outlet 35°C	-	4.65	4.65
	Seasonal space heating efficiency (η _s)		183	183
	Seasonal space heating eff. class (A+++ to D scale)		A+++	A+++
	Average climate water outlet 55°C	-	3.23	3.23
	Seasonal space heating efficiency (η _s)		126	126
	Seasonal space heating eff. class (A+++ to D scale)		A++	A++

Nominal capacity and nominal power input

Description	OAT ¹⁾ (DB)	LWT ²⁾ (DB)	Outdoor unit	HU041MR U20	HU061MR U20
			Indoor unit	HN0613M NK5	
Nominal capacity	Heating	7°C	kW	4.00	6.00
		7°C		3.70	4.60
		2°C		3.60	4.80
	Cooling	-7°C		4.00	6.00
		35°C		4.00	6.00
		35°C		4.00	6.00
Nominal power input	Heating	7°C	kW	0.78	1.21
		7°C		1.30	1.59
		2°C		0.96	1.32
	Cooling	-7°C		1.30	2.01
		35°C		0.83	1.25
		35°C		1.18	1.88
COP	Heating	7°C	W/W	5.10	4.95
		7°C		2.85	2.90
		2°C		3.75	3.65
		-7°C		3.08	2.98
EER	Cooling	35°C	W/W	4.80	4.80
		35°C		3.40	3.20

1) OAT: Outdoor Air Temperature
2) LWT: Leaving Water Temperature

Product specification (outdoor unit)

Technical specification		Unit	HU041MR U20	HU061MR U20	
Operation range (outdoor temp.)	Heating	Min. - Max.	-20 ~ 35		
	Cooling		5 ~ 48		
Compressor	Type	-	Hermetic sealed twin rotary		
	Type	-	R32		
Refrigerant	GWP (Global Warming Potential)	-	675		
	Precharged amount	g	1,100		
	t-CO ₂ eq	-	0.743		
Piping connections	Outer diameter	Liquid	mm (inch)	Ø 6.35 (1/4)	
		Gas	mm (inch)	Ø 12.7 (1/2)	
	Length	Standard	m	5	
		Max.	m	30	
	Level difference	Max.	m	30	
	Chargeless-pipe length		m	10	
Additional charging volume		g/m	20		
Rated water flow rate (at LWT 35°C)		ℓ/min	11.5	17.3	
Sound power level	Heating	Rated	57	58	
Sound pressure level (at 1 m)	Heating	Rated	49	50	
Dimensions	Unit	W x H x D	870 x 650 x 330		
Weight	Unit		44.7		
Exterior	Color / RAL code		Warm gray / RAL 7044		
	Voltage, phase, frequency	V, Ø, Hz	220-240, 1, 50		
Power supply	Rated running current	Heating	3.5	5.6	
		Cooling	3.7	5.4	
	Recommended circuit breaker	A	16	20	
Wiring connections	Power supply cable (included earth, H07RN-F)	mm ² x cores	2.5 x 3 C		

Product specification (indoor unit)

Technical specification		Unit	HN0613M NK5	
Operation range (leaving water)	Heating	Min. - Max.	15 ~ 55	
	Cooling		5 ~ 27 (16 ~ 27) ¹⁾	
	DHW		15 ~ 80 ²⁾	
Flow sensor	Measuring range	Min. - Max.	LPM	
Water pressure sensor	Measuring range	Min. - Max.	bar(G)	
Expansion vessel	Volume		ℓ	
Safety valve	Pressure limit	Upper limit	bar	
			3	
Backup heater	Type		Sheath	
	Number of heating coil	EA	2	
	Capacity combination	kW	1.5 + 1.5	
	Heating steps	Step	2	
	Power supply	V, Ø, Hz	220-240, 1, 50	
	Rated running current	A	13	
Power supply cable (included earth, H07RN-F)	mm ² x cores		2.5 x 3 C	
Piping connections	Water circuit	Inlet	inch	
		Outlet	inch	
	Refrigerant circuit	Gas (outside diameter)	mm (inch)	Male PT 1" according to ISO 7-1 (tapered pipe threads)
		Liquid (outside diameter)	mm (inch)	Male PT 1" according to ISO 7-1 (tapered pipe threads)
Wiring connections	Power and communication cable (included earth, H07RN-F)	mm ² x cores	0.75 x 4 C	
Sound power level	Heating	Rated	44	
Dimensions	Unit	W x H x D	490 x 850 x 315	
Weight	Unit		37.8	
Exterior	Color / RAL code		Noble white / RAL 9016	

1) When a fan coil unit is not used.
2) DHW 50 ~ 80°C operating is available only when the booster heater is operating.
3) When connecting the refrigerant pipe, the adaptors provided with the outdoor unit must be installed on the connection of the indoor unit.

- Note
- Due to our policy of innovation, some specifications may be changed without notification.
 - Wiring cable size must comply with the applicable local and national codes. Especially the power cable and circuit breaker should be selected in accordance with that.
 - Sound power level is measured on the rated condition in accordance with ISO 9614 standard. Sound pressure level is converted from sound power level based on a tonality penalty of 0 dB and installation in free-field. The directivity index (Q) is assumed as 2. Therefore, these values can be increased owing to ambient conditions during operation. Rated sound power level is in accordance with EN12102-1 under condition of EN14825.
 - Performances are in accordance with EN14511 and reflect ErP testing conditions. Above gives the declared values at rated conditions acc. ErP regulation
 - Rated running current: outdoor Temp. 7°C (DB) / 6°C (WB), Leaving Water Temp. 35°C
 - Interconnected pipe length is standard length and difference of elevation (outdoor - indoor unit) is 0 m.
 - This product contains fluorinated greenhouse gases.
 - All installation sites must be equipped with an earth leakage circuit breaker (ELCB).

Performance Table for Heating Operation

Maximum heating capacity (including defrost effect)

HU041MR U20 + HN0613M NK5

Outdoor temperature	LWT 30°C	LWT 35°C	LWT 40°C	LWT 45°C	LWT 50°C	LWT 55°C
	Capacity (kW)					
-20°C DB	4.00	4.00	4.00	4.00	-	-
-15°C DB	4.00	4.00	4.00	4.00	4.00	-
-7°C DB	4.00	4.00	4.00	4.00	4.00	4.00
-4°C DB	4.00	4.00	4.00	4.00	4.00	4.00
-2°C DB	4.00	4.00	4.00	4.00	4.00	4.00
2°C DB	4.00	4.00	4.00	4.00	4.00	4.00
7°C DB	4.00	4.00	4.00	4.00	4.00	4.00
10°C DB	4.00	4.00	4.00	4.00	4.00	4.00
15°C DB	4.00	4.00	4.00	4.00	4.00	4.00
18°C DB	4.00	4.00	4.00	4.00	4.00	4.00
20°C DB	4.00	4.00	4.00	4.00	4.00	4.00
35°C DB	4.00	4.00	4.00	4.00	4.00	4.00

HU061MR U20 + HN0613M NK5

Outdoor temperature	LWT 30°C	LWT 35°C	LWT 40°C	LWT 45°C	LWT 50°C	LWT 55°C
	Capacity (kW)					
-20°C DB	4.92	4.78	4.64	4.50	-	-
-15°C DB	5.56	5.52	5.48	5.44	5.40	-
-7°C DB	6.00	6.00	6.00	6.00	6.00	6.00
-4°C DB	6.00	6.00	6.00	6.00	6.00	6.00
-2°C DB	6.00	6.00	6.00	6.00	6.00	6.00
2°C DB	6.00	6.00	6.00	6.00	6.00	6.00
7°C DB	6.00	6.00	6.00	6.00	6.00	6.00
10°C DB	6.00	6.00	6.00	6.00	6.00	6.00
15°C DB	6.00	6.00	6.00	6.00	6.00	6.00
18°C DB	6.00	6.00	6.00	6.00	6.00	6.00
20°C DB	6.00	6.00	6.00	6.00	6.00	6.00
35°C DB	6.00	6.00	6.00	6.00	6.00	6.00

Note
 1. DB : Dry Bulb Temperature (°C), LWT : Leaving Water Temperature (°C)
 2. Direct interpolation is permissible. Do not extrapolate.
 3. Measuring procedure follows EN-14511.
 • Rated values are based on standard conditions and can be found on specifications.
 • Above table values may not be matched according to installation conditions. Except for rated values, the performance is not guaranteed.
 • The rating might slightly vary depending on test standards or countries.
 4. The shaded areas are not guaranteed continuous operation.

Performance Table for Cooling Operation

Maximum cooling capacity

HU041MR U20 + HN0613M NK5

Outdoor temperature	LWT 7°C	LWT 10°C	LWT 13°C	LWT 15°C	LWT 18°C	LWT 20°C	LWT 22°C
	Capacity (kW)						
10°C DB	4.00	4.00	4.00	4.00	4.00	4.00	4.00
20°C DB	4.00	4.00	4.00	4.00	4.00	4.00	4.00
30°C DB	4.00	4.00	4.00	4.00	4.00	4.00	4.00
35°C DB	4.00	4.00	4.00	4.00	4.00	4.00	4.00
40°C DB	4.00	4.00	4.00	4.00	4.00	4.00	4.00
45°C DB	4.00	4.00	4.00	4.00	4.00	4.00	4.00

HU061MR U20 + HN0613M NK5

Outdoor temperature	LWT 7°C	LWT 10°C	LWT 13°C	LWT 15°C	LWT 18°C	LWT 20°C	LWT 22°C
	Capacity (kW)						
10°C DB	6.00	6.00	6.00	6.00	6.00	6.00	6.00
20°C DB	6.00	6.00	6.00	6.00	6.00	6.00	6.00
30°C DB	6.00	6.00	6.00	6.00	6.00	6.00	6.00
35°C DB	6.00	6.00	6.00	6.00	6.00	6.00	6.00
40°C DB	5.74	5.81	5.87	5.91	6.00	6.00	6.00
45°C DB	5.48	5.61	5.73	5.81	5.94	6.00	6.00

Note
 1. DB : Dry Bulb Temperature (°C), LWT : Leaving Water Temperature (°C)
 2. Direct interpolation is permissible. Do not extrapolate.
 3. Measuring procedure follows EN-14511.
 • Rated values are based on standard conditions and can be found on specifications.
 • Above table values may not be matched according to installation conditions. Except for rated values, the performance is not guaranteed.
 • The rating might slightly vary depending on test standards or countries.
 4. The shaded areas are not guaranteed continuous operation.

Drawings

Category	Unit	Model name	
		Capacity (kW)	
1 Phase model 220 - 240 V, 1 Ø, 50 Hz	Outdoor unit	HU041MR U20	HU061MR U20
	Indoor unit	HN0613M NK5	

HU041MR U20 / HU061MR U20

[Unit: mm]

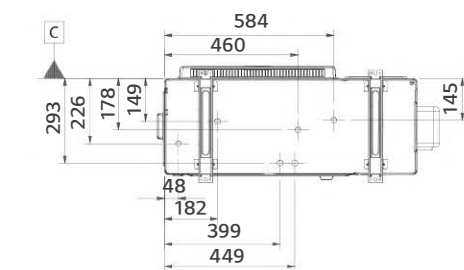
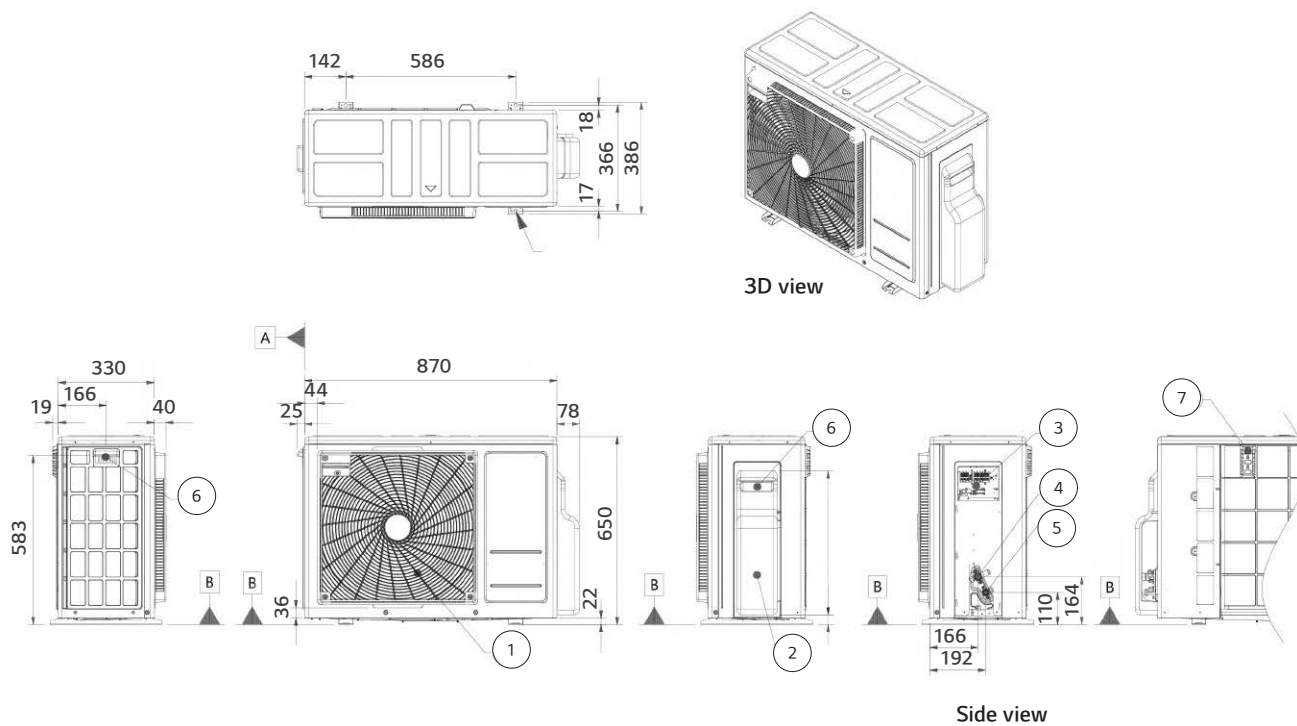

No.	Part name	Description
1	Air outlet	-
2	Control cover & SVC valve cover	-
3	Power and communication cable connection	-
4	Gas pipe connection	Flare joint
5	Liquid pipe connection	Flare joint
6	Handle	-
7	Intake air temperature sensor cover	-

HN0613M NK5

[Unit: mm]

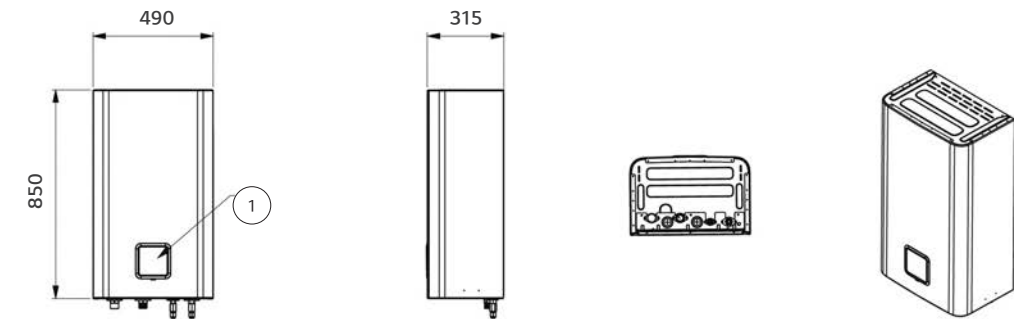

No.	Part name	Description
1	Control panel	Built-in remote controller

Internal

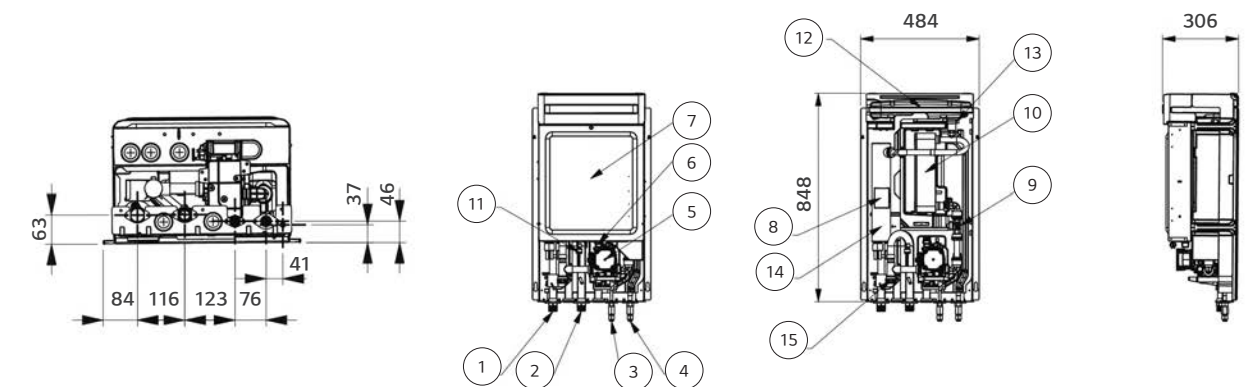

No.	Part name	Description
1	Leaving water pipe	Male PT 1" according to ISO 7-1 (tapered pipe threads)
2	Entering water pipe	Male PT 1" according to ISO 7-1 (tapered pipe threads)
3	Refrigerant piping connection	Ø 6.35 ¹⁾ (mm)
4	Refrigerant piping connection	Ø 12.7 ¹⁾ (mm)
5	Water pump	To circulate water inside the system
6	Safety valve	Open at water pressure 3 bar
7	Control box	PCB and terminal blocks
8	Thermostat	Cut-off power input to electric heater at 90°C
9	Flow sensor	To measure the water flow rate (5-80 LPM)
10	Plate heat exchanger	Heat exchange between refrigerant and water
11	Pressure sensor	To measure the water pressure (0-2 MPa)
12	Expansion tank	Absorbing volume change of heated water
13	Air vent	Air purging when charging water
14	Backup heater	3 kW
15	Strainer	Filtering and stacking particles inside circulating water

1) When connecting the refrigerant pipe, the adaptors provided with the outdoor unit must be installed on the connection of the indoor unit.

THERMA V™ R32

R32 SPLIT 5/7/9 kW HYDRO BOX

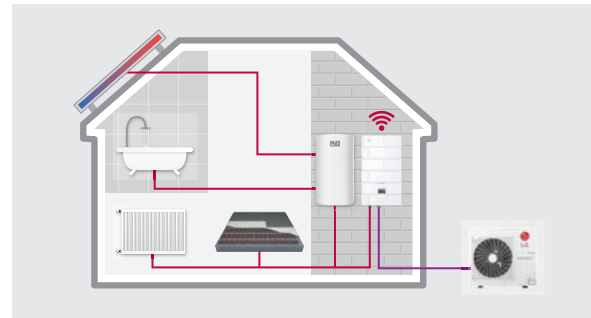
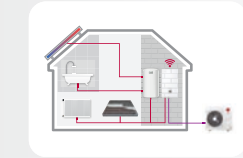

Energy Label

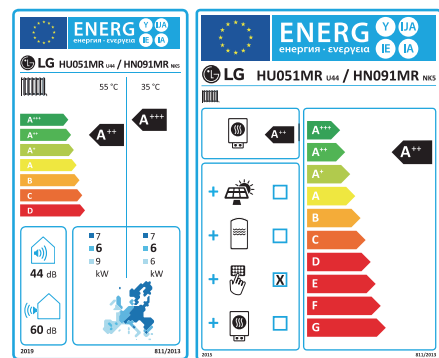

* 5 kW 1 Ø model.
* A+++ to D scale.

Excellent performance & efficiency



User convenience

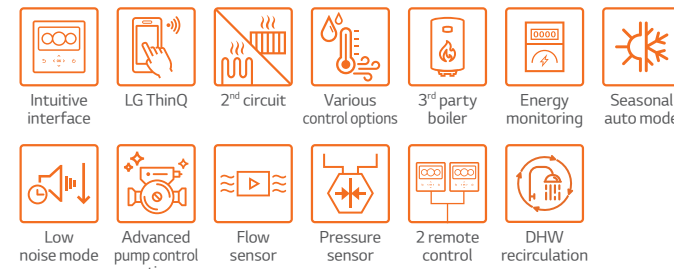

Easy installation & maintenance

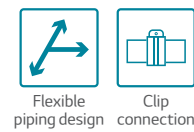

* Detailed description for each function is presented on page 44 – 54.

R32 Split Hydro Box Introduction

The LG Therma V R32 Split Hydro Box is a hydro box type comprising a separate indoor and outdoor unit, which are connected by refrigerant piping. Hydronic components such as a plate heat exchanger, an expansion tank and a water pump are located within the indoor unit, making the unit capable of withstanding freezing outside ambient temperatures. The outdoor unit is on offer in 4/6 kW and 5/7/9 kW capacity range and R32 Split 5/7/9 kW model is suitable for both new build and renovation projects.

Key Components

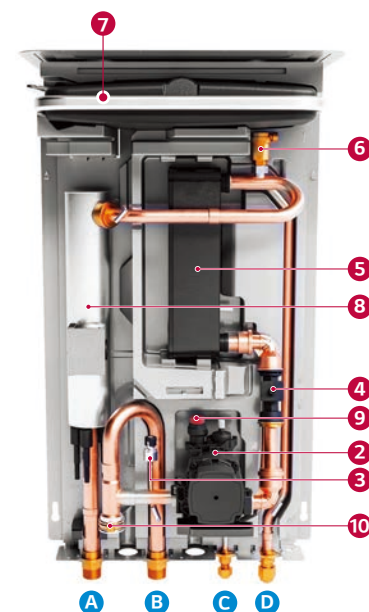

Components

- 1 Standard III remote controller (attached on the front panel)
- 2 Water pump
- 3 Water pressure sensor
- 4 Flow sensor
- 5 Plate type heat exchanger (ref/water)
- 6 Air vent valve
- 7 Expansion vessel (8 l)
- 8 Back up electric heater (6 kW)
- 9 Safety valve
- 10 Strainer

Connections

- A Heating circuit outlet pipe (male PT 1" *)
- B Heating circuit inlet pipe (male PT 1" *)
- C Refrigerant liquid pipe (SAE 3/8")
- D Refrigerant gas pipe (SAE 5/8")



Flexible Refrigerant Piping Design

Installation flexibility is enabled by Therma V Split's long pipe length (up to 50 m) and the fact that the refrigerant piping can be connected in three directions: front, side and rear.

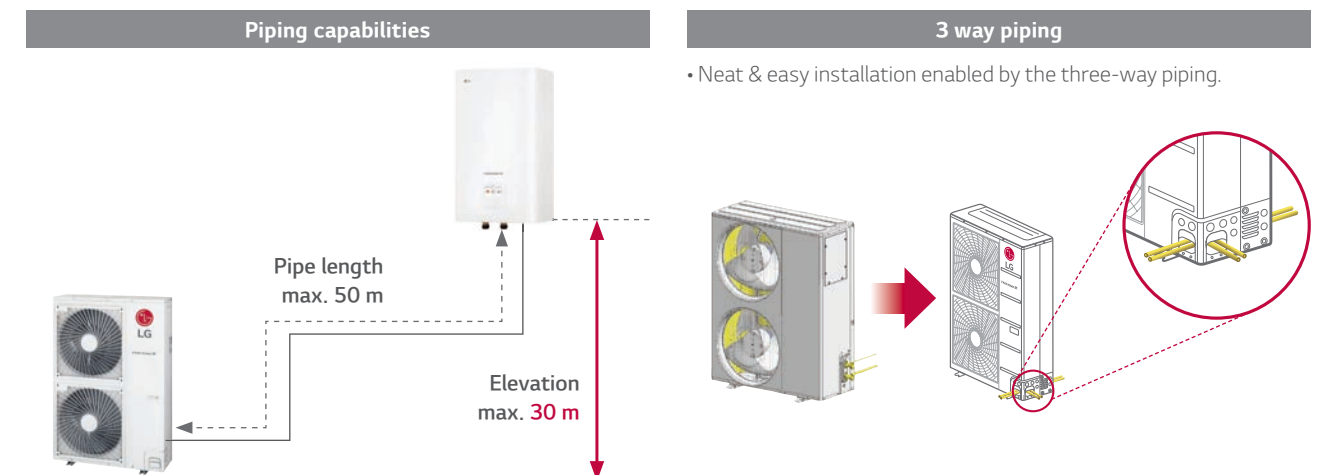

R32 Split 5/7/9 kW Hydro Box



Indoor unit
HN091MR NK5
Outdoor unit
HU051MR U44
HU071MR U44
HU091MR U44



Features

- Refrigerant pipes connect IDU & ODU
- SCOP up to 4.65 (average climate / low temp. application): **A+++**
SCOP up to 3.23 (average climate / mid temp. application): **A++**
- COP up to 4.90 (outdoor air 7°C / leaving water 35°C)
- 100 % heating capacity at -7°C OAT (@ LWT 35°C)
- Wide operation range (ambient: -25 ~ 35°C / water side: 15 ~ 65°C)
- Built-in water flow & pressure sensors to monitor real-time water circuit
- R32 refrigerant with reduced Global Warming Potential (GWP)
- R1 Compressor
- Black Fin heat exchanger
- LG ThinQ
- Keymark / EHPA (for Germany, Austria and Switzerland) / MCS / Eurovent certification

Model line-up

Category	Unit	Model name		
		Capacity (kW)		
		5.5	7.0	9.0
1 Phase model 220 ~ 240 V, 1 Ø, 50 Hz	Outdoor unit	HU051MR U44	HU071MR U44	HU091MR U44
	Indoor unit	HN091MR NK5		

Seasonal energy

Description	Outdoor unit		HU051MR U44	HU071MR U44	HU091MR U44	
	Indoor unit		HN091MR NK5			
Space heating (according to EN14825)	Average climate water outlet 35°C	SCOP	-	4.65	4.65	4.65
		Seasonal space heating efficiency (η _s)	%	183	183	183
		Seasonal space heating eff. class (A+++ to D scale)	-	A+++	A+++	A+++
	Average climate water outlet 55°C	SCOP	-	3.23	3.23	3.23
		Seasonal space heating efficiency (η _s)	%	126	126	126
		Seasonal space heating eff. class (A+++ to D scale)	-	A++	A++	A++

Nominal capacity and nominal power input

Description	OAT ¹⁾ (DB)	LWT ²⁾ (DB)	Outdoor unit			
			Indoor unit			
			HU051MR U44	HU071MR U44	HU091MR U44	
Nominal capacity	Heating	7°C 35°C	kW	5.50	7.00	9.00
		7°C 55°C		5.50	5.50	5.50
		2°C 35°C		3.30	4.20	5.40
	Cooling	35°C 18°C		5.50	7.00	9.00
		35°C 7°C		5.50	7.00	9.00
		7°C 35°C		1.12	1.43	1.94
Nominal power input	Heating	7°C 55°C	kW	2.04	2.04	2.04
		2°C 35°C		0.94	1.20	1.54
		35°C 18°C		1.20	1.56	2.14
	Cooling	35°C 7°C		1.96	2.59	3.46
		7°C 35°C		4.90	4.90	4.65
		7°C 55°C		2.70	2.70	2.70
COP	Heating	2°C 35°C	3.52	3.51	3.50	
		35°C 18°C	4.60	4.50	4.20	
EER	Cooling	35°C 7°C	2.80	2.70	2.60	

1) OAT : Outdoor Air Temperature
2) LWT : Leaving Water Temperature

Product specification (outdoor unit)

Technical specification		Unit	HU051MR U44	HU071MR U44	HU091MR U44
Operation range (outdoor temp.)	Heating	Min. - Max.	-25 ~ 35		
	Cooling		5 ~ 48		
Compressor	Quantity	EA	1		
	Type	-	Hermetic sealed scroll		
Refrigerant	Type	-	R32		
	GWP (Global Warming Potential)	-	675		
	Precharged amount	g	1,500		
	t-CO ₂ eq	-	1.013		
Piping connections	Outside diameter	Gas	mm (inch)		
		Liquid	Ø 15.88 (5/8)		
	Length	Standard	m		
		Max.	50		
	Level difference	Max.	m		
	Chargeless-pipe length		m		
Additional charging volume		g/m	40		
Rated water flow rate (at LWT 35°C)		LPM	15.8	20.1	25.9
Sound power level	Heating	Rated	dB(A)		
Sound pressure level (at 1 m)	Heating	Rated	dB(A)		
Dimensions	Unit	W x H x D	mm		
Weight	Unit		kg		
Exterior	Color / RAL code		Warm gray / RAL 7044		
	Voltage, phase, frequency	V, Ø, Hz	220-240, 1, 50		
Power supply	Rated running current	Heating	5.0	6.3	8.6
		Cooling	5.3	6.9	9.5
	Recommended circuit breaker		A	20	25
Wiring connections	Power supply cable (included earth, H07RN-F)	mm ² x cores	4.0 x 3 C		

Product specification (indoor unit)

Technical specification		Unit	HN091MR NK5
Operation range (leaving water)	Heating	Min. - Max.	15 ~ 65
	Cooling		5 ~ 27 (16 ~ 27) ¹⁾
Flow sensor	Measuring range	Min. - Max.	LPM
	Water pressure sensor	Measuring range	Min. - Max.
Expansion vessel	Volume		l
Safety valve	Pressure limit	Upper limit	bar
	Type		-
Backup heater	Number of heating coil	EA	2
	Capacity combination	kW	3.0 + 3.0
	Heating steps	Step	2
	Power supply	V, Ø, Hz	220-240, 1, 50
	Rated running current	A	25.0
	Power supply cable (included earth, H07RN-F)	mm ² x cores	4.0 x 3 C
Piping connections	Water circuit	Inlet	inch
		Outlet	inch
	Refrigerant circuit	Gas (outside diameter)	mm (inch)
		Liquid (outside diameter)	mm (inch)
Wiring connections	Power and communication cable (included earth, H07RN-F)	mm ² x cores	0.75 x 4 C
Sound power level	Heating	Rated	dB(A)
Dimensions	Unit	W x H x D	mm
Weight	Unit		kg
Exterior	Color / RAL code		-

1) When a fan coil unit is not used.
2) DHW 55 ~ 80°C operating is available only when the booster heater is operating.

- Note
- Due to our policy of innovation, some specifications may be changed without notification.
 - Wiring cable size must comply with the applicable local and national codes. Especially the power cable and circuit breaker should be selected in accordance with that.
 - Sound power level is measured on the rated condition in accordance with ISO 9614 standard. Sound pressure level is converted from sound power level based on a tonality penalty of 0 dB and installation in free-field. The directivity index (Q) is assumed as 2. Therefore, these values can be increased owing to ambient conditions during operation. Rated sound power level is in accordance with EN12102-1 under condition of EN14825.
 - Performances are in accordance with EN14511 and reflect ErP testing conditions. Above gives the declared values at rated conditions acc. ErP regulation
 - Rated running current: outdoor Temp. 7°C DB / 6°C WB, LWT 35°C
 - Interconnected pipe length is standard length and difference of elevation (outdoor - indoor unit) is 0 m.
 - This product contains fluorinated greenhouse gases.
 - All installation sites must be equipped with an earth leakage circuit breaker (ELCB).

Performance Table for Heating Operation

Maximum heating capacity (including defrost effect)

HU051MR U44 + HN091MR NK5

Outdoor temperature	LWT 30°C	LWT 35°C	LWT 40°C	LWT 45°C	LWT 50°C	LWT 55°C	LWT 60°C	LWT 65°C
	Capacity (kW)							
-25°C DB	4.02	3.90	3.78	3.66	-	-	-	-
-20°C DB	4.64	4.51	4.38	4.26	4.13	-	-	-
-15°C DB	5.26	5.12	4.99	4.85	4.72	4.58	-	-
-7°C DB	5.50	5.50	5.50	5.50	5.50	5.50	5.50	-
-4°C DB	5.50	5.50	5.50	5.50	5.50	5.50	5.50	-
-2°C DB	5.50	5.50	5.50	5.50	5.50	5.50	5.50	-
2°C DB	5.50	5.50	5.50	5.50	5.50	5.50	5.50	5.50
7°C DB	5.50	5.50	5.50	5.50	5.50	5.50	5.50	5.50
10°C DB	5.50	5.50	5.50	5.50	5.50	5.50	5.50	5.50
15°C DB	5.50	5.50	5.50	5.50	5.50	5.50	5.50	5.50
18°C DB	5.50	5.50	5.50	5.50	5.50	5.50	5.50	5.50
20°C DB	5.50	5.50	5.50	5.50	5.50	5.50	5.50	5.50
35°C DB	5.50	5.50	5.50	5.50	5.50	5.50	5.50	5.50

HU071MR U44 + HN091MR NK5

Outdoor temperature	LWT 30°C	LWT 35°C	LWT 40°C	LWT 45°C	LWT 50°C	LWT 55°C	LWT 60°C	LWT 65°C
	Capacity (kW)							
-25°C DB	5.00	4.85	4.71	4.56	-	-	-	-
-20°C DB	5.58	5.43	5.27	5.11	4.95	-	-	-
-15°C DB	6.17	6.00	5.83	5.66	5.49	5.32	-	-
-7°C DB	7.00	7.00	7.00	7.00	7.00	7.00	7.00	-
-4°C DB	7.00	7.00	7.00	7.00	7.00	7.00	7.00	-
-2°C DB	7.00	7.00	7.00	7.00	7.00	7.00	7.00	-
2°C DB	7.00	7.00	7.00	7.00	7.00	7.00	7.00	7.00
7°C DB	7.00	7.00	7.00	7.00	7.00	7.00	7.00	7.00
10°C DB	7.00	7.00	7.00	7.00	7.00	7.00	7.00	7.00
15°C DB	7.00	7.00	7.00	7.00	7.00	7.00	7.00	7.00
18°C DB	7.00	7.00	7.00	7.00	7.00	7.00	7.00	7.00
20°C DB	7.00	7.00	7.00	7.00	7.00	7.00	7.00	7.00
35°C DB	7.00	7.00	7.00	7.00	7.00	7.00	7.00	7.00

HU091MR U44 + HN091MR NK5

Outdoor temperature	LWT 30°C	LWT 35°C	LWT 40°C	LWT 45°C	LWT 50°C	LWT 55°C	LWT 60°C	LWT 65°C
	Capacity (kW)							
-25°C DB	6.40	6.20	6.00	5.80	-	-	-	-
-20°C DB	7.23	7.00	6.77	6.54	6.31	-	-	-
-15°C DB	8.06	7.80	7.54	7.28	7.02	6.76	-	-
-7°C DB	9.00	9.00	9.00	9.00	9.00	9.00	9.00	-
-4°C DB	9.00	9.00	9.00	9.00	9.00	9.00	9.00	-
-2°C DB	9.00	9.00	9.00	9.00	9.00	9.00	9.00	-
2°C DB	9.00	9.00	9.00	9.00	9.00	9.00	9.00	9.00
7°C DB	9.00	9.00	9.00	9.00	9.00	9.00	9.00	9.00
10°C DB	9.00	9.00	9.00	9.00	9.00	9.00	9.00	9.00
15°C DB	9.00	9.00	9.00	9.00	9.00	9.00	9.00	9.00
18°C DB	9.00	9.00	9.00	9.00	9.00	9.00	9.00	9.00
20°C DB	9.00	9.00	9.00	9.00	9.00	9.00	9.00	9.00
35°C DB	9.00	9.00	9.00	9.00	9.00	9.00	9.00	9.00

Note
 1. DB: Dry Bulb Temperature (°C), LWT: Leaving Water Temperature (°C)
 2. Direct interpolation is permissible. Do not extrapolate.
 3. Measuring procedure follows EN-14511.
 • Rated values are based on standard conditions and can be found on specifications.
 • Above table values may not be matched according to installation conditions. Except for rated values, the performance is not guaranteed.
 • The rating might slightly vary depending on test standards or countries.
 4. The shaded areas are not guaranteed continuous operation.

Performance Table for Cooling Operation

Maximum cooling capacity

HU051MR U44 + HN091MR NK5

Outdoor temperature	LWT 7°C	LWT 10°C	LWT 13°C	LWT 15°C	LWT 18°C	LWT 20°C	LWT 22°C
	Capacity (kW)						
10°C DB	6.42	6.95	7.49	7.85	8.39	8.75	9.11
20°C DB	6.05	6.37	6.70	6.91	7.23	7.45	7.66
30°C DB	5.68	5.79	5.90	5.97	6.08	6.15	6.22
35°C DB	5.50	5.50	5.50	5.50	5.50	5.50	5.50
40°C DB	5.32	5.34	5.35	5.37	5.38	5.40	5.41
45°C DB	5.13	5.17	5.21	5.23	5.27	5.29	5.32

HU071MR U44 + HN091MR NK5

Outdoor temperature	LWT 7°C	LWT 10°C	LWT 13°C	LWT 15°C	LWT 18°C	LWT 20°C	LWT 22°C
	Capacity (kW)						
10°C DB	8.17	8.85	9.54	9.99	10.68	11.13	11.59
20°C DB	7.70	8.11	8.52	8.80	9.21	9.48	9.75
30°C DB	7.23	7.37	7.51	7.60	7.74	7.83	7.92
35°C DB	7.00	7.00	7.00	7.00	7.00	7.00	7.00
40°C DB	6.77	6.79	6.81	6.83	6.85	6.87	6.88
45°C DB	6.53	6.58	6.63	6.66	6.70	6.74	6.77

HU091MR U44 + HN091MR NK5

Outdoor temperature	LWT 7°C	LWT 10°C	LWT 13°C	LWT 15°C	LWT 18°C	LWT 20°C	LWT 22°C
	Capacity (kW)						
10°C DB	10.50	11.38	12.26	12.85	13.73	14.31	14.90
20°C DB	9.90	10.43	10.96	11.31	11.84	12.19	12.54
30°C DB	9.30	9.48	9.65	9.77	9.95	10.06	10.18
35°C DB	9.00	9.00	9.00	9.00	9.00	9.00	9.00
40°C DB	8.70	8.73	8.76	8.78	8.81	8.83	8.85
45°C DB	8.40	8.46	8.52	8.56	8.62	8.66	8.70

Note
 1. DB: Dry Bulb Temperature (°C), LWT: Leaving Water Temperature (°C)
 2. Direct interpolation is permissible. Do not extrapolate.
 3. Measuring procedure follows EN-14511.
 • Rated values are based on standard conditions and can be found on specifications.
 • Above table values may not be matched according to installation conditions. Except for rated values, the performance is not guaranteed.
 • The rating might slightly vary depending on test standards or countries.
 4. The shaded areas are not guaranteed continuous operation.

Drawings

Category	Unit	Model name		
		Capacity (kW)		
1 Phase model 220 - 240 V, 1 Ø, 50 Hz	Outdoor unit	HU051MR U44	HU071MR U44	HU091MR U44
	Indoor unit	HN091MR NK5		

HU051MR U44 / HU071MR U44 / HU091MR U44

[Unit: mm]

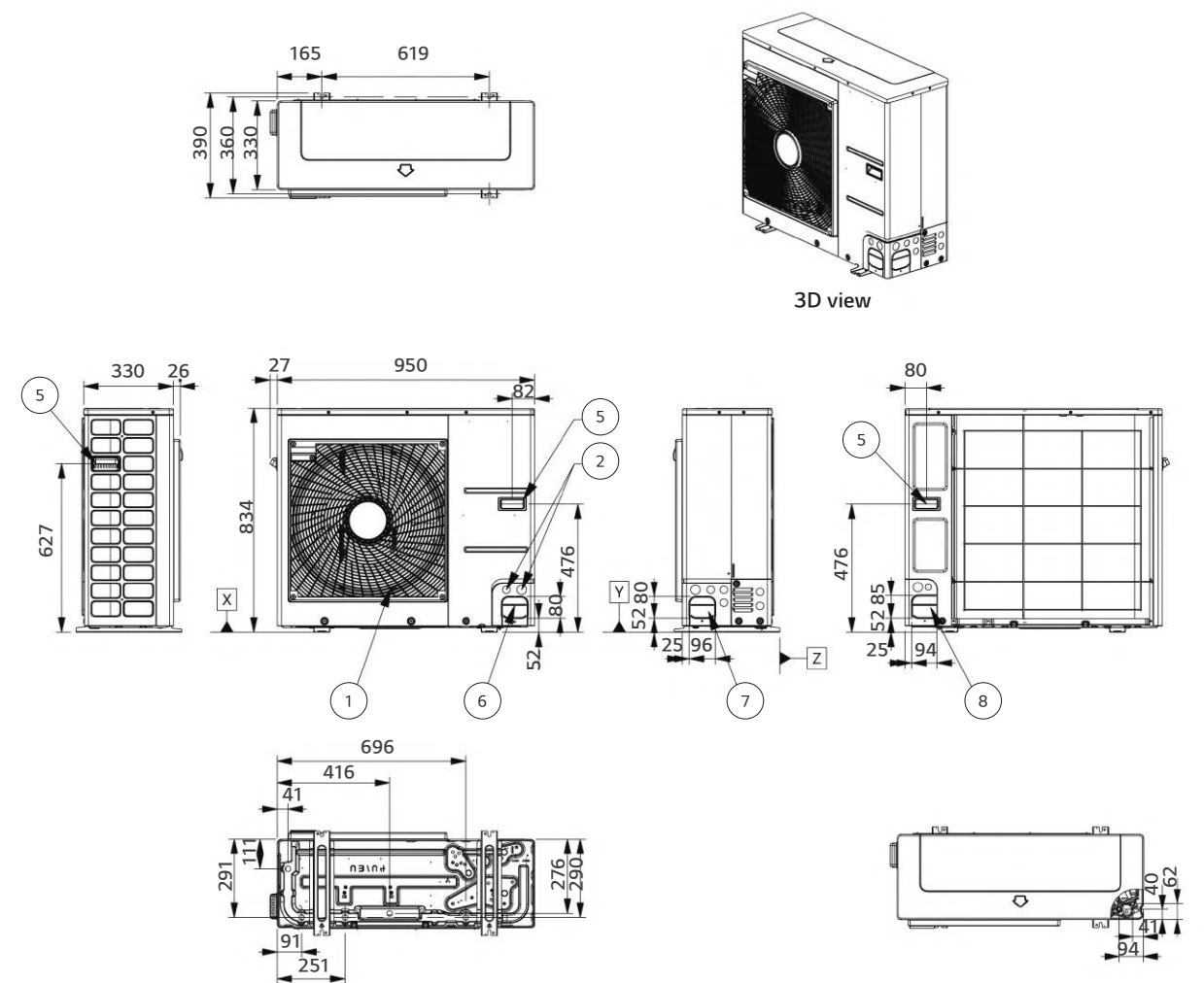

No.	Part name	Description
1	Air outlet	-
2	Power and communication cable hole	-
3	Gas pipe connection	Flare joint
4	Liquid pipe connection	Flare joint
5	Handle	-
6	Pipe routing hole (front)	-
7	Pipe routing hole (side)	-
8	Pipe routing hole (back)	-

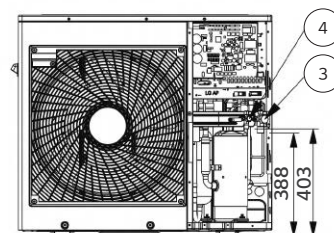

HN091MR NK5

External

[Unit: mm]

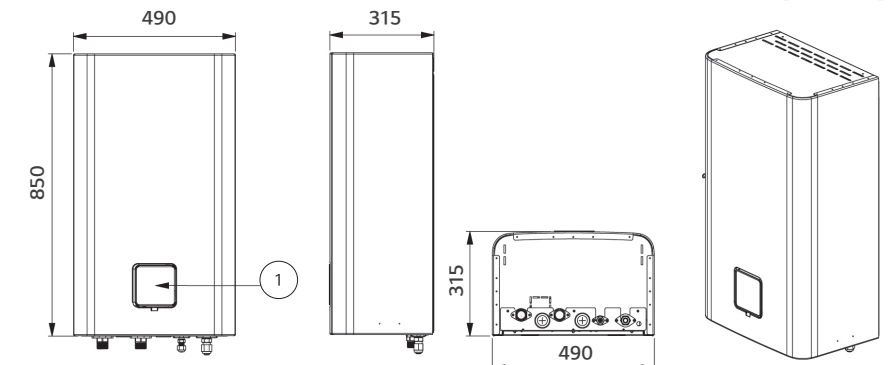

No.	Part name	Description
1	Control panel	Built-in remote controller

Internal

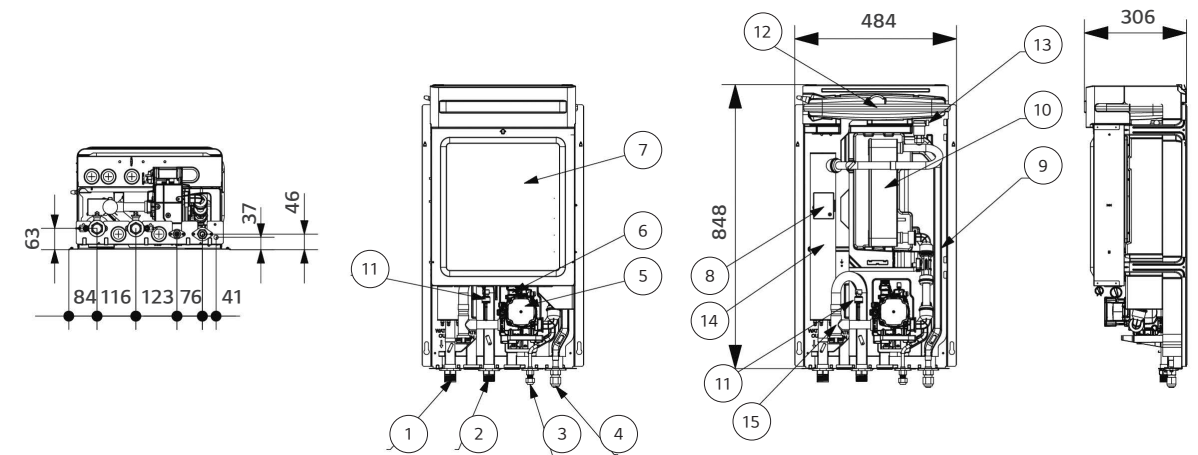

No.	Part name	Description
1	Leaving water pipe	Male PT 1" according to ISO 7-1 (tapered pipe threads)
2	Entering water pipe	Male PT 1" according to ISO 7-1 (tapered pipe threads)
3	Refrigerant pipe (liquid)	Ø 9.52 (mm)
4	Refrigerant pipe (gas)	Ø 15.88 (mm)
5	Water pump	To circulate water inside the system
6	Safety valve	Open at water pressure 3 bar
7	Control box	PCB and terminal blocks
8	Thermal switch	Cut-off power input to electric heater at 90°C
9	Flow sensor	To measure the water flow rate (5-80 LPM)
10	Plate heat exchanger	Heat exchange between refrigerant and water
11	Pressure sensor	To measure the water pressure (0-2 MPa)
12	Expansion tank	Absorbing volume change of heated water
13	Air vent	Air purging when charging water
14	Backup heater	6 kW
15	Strainer	Filtering and stacking particles inside circulating water



THERMA V™ R32

R32 SPLIT 4/6 kW IWT

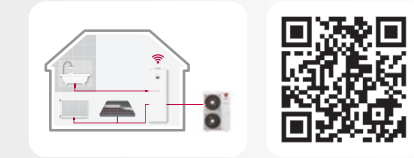

INTRODUCTION

THERMA V FEATURES

MONOBLOC

HYDROSPLIT

SPLIT

WATER HEATER

ACCESSORIES

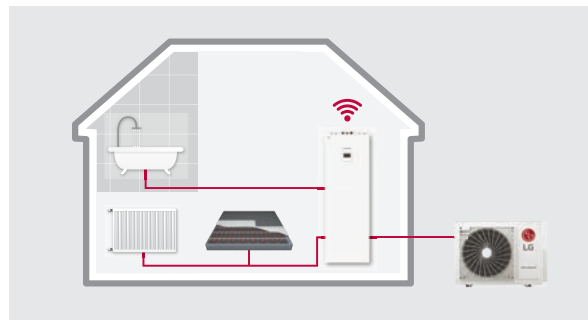

Excellent performance & efficiency

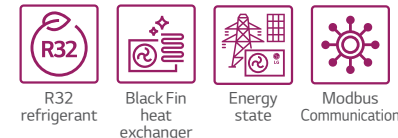

User convenience

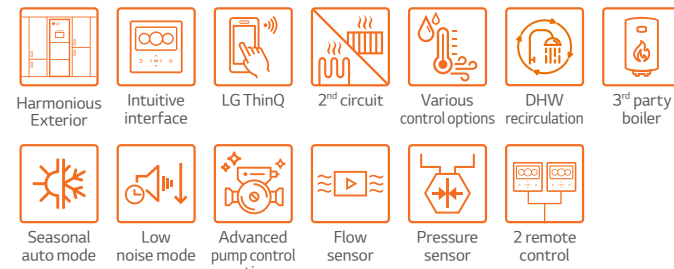

Easy installation & maintenance



* Detailed description for each function is presented on page 44 – 54.

Energy Label

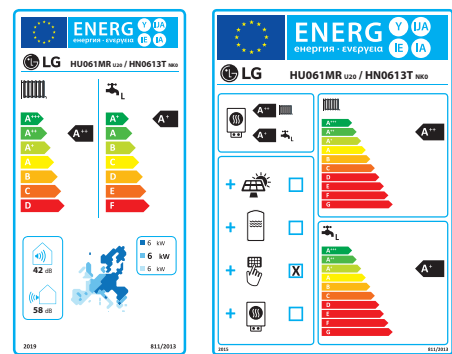

* 16 kW 3 Ø model.
* A+++ to D scale.

R32 Split IWT Introduction

LG Therma V Split IWT with an integrated indoor hot water tank – a domestic hot water supply, space heating and cooling solution – has reached a new era of innovation. A stainless steel water tank reduces the risk of corrosion, while an internal coil type heat exchanger contributes to higher efficiency. Compact and lightweight components allow quicker and easier installation, with various advanced control options providing for user convenience.

The outdoor unit is on offer in 4/6 kW and 5/7/9 kW capacity range and R32 Split 4/6 kW model is suitable for new build houses that are well insulated and require a small heating load.

Key Components

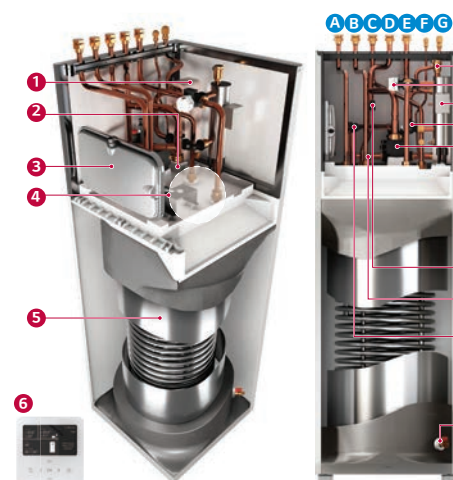

Components

- 1 Plate heat exchanger (ref. / water)
- 2 Strainer
- 3 Expansion tank for heating (8 l)
- 4 Reserved space for DHW expansion tank
- 5 DHW storage tank (stainless steel, 200 l) with internal coil type heat exchanger
- 6 Standard III remote controller (attached on front panel)
- 7 Air vent valve
- 8 3 Way diverting valve (DC)
- 9 Electric back-up heater (3 kW)
- 10 Water flow sensor
- 11 Main water pump with air vent and safety valve (water circuit, 3 bar)
- 12 Water pressure sensor
- 13 Drain valve for water circuit
- 14 Safety valve (DHW tank, 10 bar)
- 15 Drain valve for DHW tank

Connections

- A DHW recirculation pipe (female G1" *)
- B Domestic hot water outlet pipe (female G1" *)
- C Domestic cold water inlet pipe (female G1" *)
- D Heating circuit inlet pipe (female G1" *)
- E Heating circuit outlet pipe (female G1" *)
- F Refrigerant liquid pipe (SAE 1/4" with connector **)
- G Refrigerant gas pipe (SAE 1/2" with connector **)

* According to ISO 228-1 (parallel pipe threads)
** In case of Split 4/6 kW model, the adaptors provided with the outdoor unit must be separately installed on the gas/liquid connection of the indoor unit when connecting the refrigerant pipe. After installing the adaptors, the liquid and gas connection size becomes Ø 6.35 (1/4 inch) and Ø 12.7 (1/2 inch) respectively.

All-in-One Solution: Integrated Water Tank Type

Therma V R32 Split IWT is the perfect space-saving solution for residential application thanks to its fully integrated hot water tank. Unlike in the case of typical separate installation, in this all-in-one solution hydronic components and Domestic Hot Water (DHW) are pre-wired, which requires reduced installation time and saves valuable living space. Therma V R32 Split IWT is easy to set up and operate while it demonstrates outstanding reliability and efficiency.

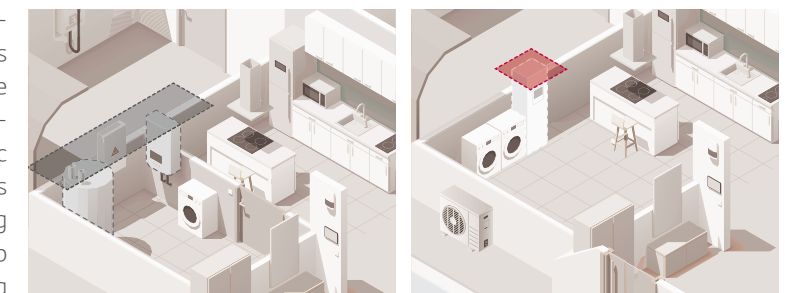

Conventional

LG Therma V R32 Split IWT
(less installation space required)

Small Refrigerant Amount - free from minimum floor area requirements due to R32 refrigerant

Minimum floor space requirements do not apply to R32 Split 4/6 kW, as the maximum refrigerant amount (including 30 m pipes) used in the product is smaller than the minimum set by regulation. As a result, there are more opportunities for flexible design and installation.

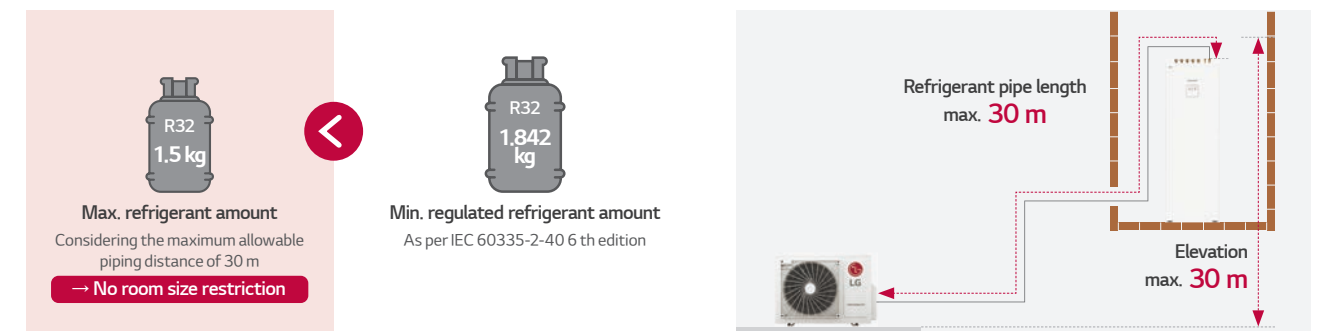

Reduced Noise Level

The R32 Split outdoor unit can be installed at the minimum of 4.5 m away¹⁾ from neighboring houses while complying with noise-related requirements in most European countries, including Germany. (based on 4 kW ODU & low noise mode)

Description	Germany	Austria	Switzerland	Netherlands
Sound pressure threshold	Day time	50 dB (A) (06:00 – 22:00)	40 dB (A) (06:00 – 19:00)	45 dB (A) (07:00 – 19:00)
	Evening	-	35 dB (A) (19:00 – 22:00)	-
	Night time	35 dB (A) (22:00 – 06:00)	30 dB (A) (22:00 – 06:00)	35 dB (A) (19:00 – 07:00)

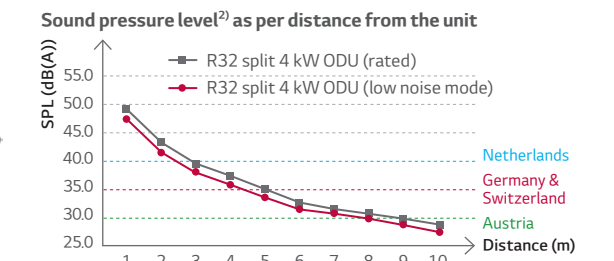
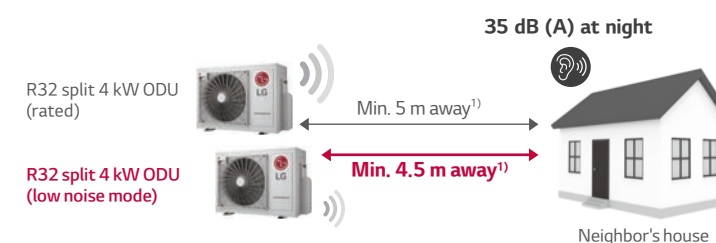

1) Minimum distance to be away from a neighboring property may vary depending on installation conditions and noise regulations in individual countries.
2) Sound pressure level is converted from sound power level of low noise mode based on a tonality penalty of 0 dB and installation in free-field. The directivity index (Q) is assumed as 2.

R32 Split 4/6 kW IWT



Indoor unit
HN0613T NK0
Outdoor unit
HU041MR U20
HU061MR U20



Black Fin ThinQ

* Keymark, Eurovent and EHPA label under development

Features

- Answers the needs of new build houses with good insulation and a small heating demand
- Demonstrates a lower noise level (sound pressure level at 3 m : 39 dB (A) for 4 kW / 40 dB (A) for 6 kW)



All-in-one integration

- Quick and easy installation
- DHW tank and hydronic component integration
- Integrated 3 kW backup heater and expansion tank for heating (8 ℓ)

Enhanced installation flexibility

- Free from minimum floor area requirements due to R32 refrigerant (max. refrigerant amount (including 30 m pipes) < 1.842 kg)
- Light weight and compact size
- Max. 30 m refrigerant piping

High efficiency & operational range

- SCOP up to 4.65 / 3.23 (low temp. / mid temp. application): 
- Water heating efficiency 133 % (4,6 kW, profile L): 
- COP up to 5.10 (outdoor air 7°C / leaving water 35°C)
- Operation range (ambient: -20 ~ 35°C / water side: 15 ~ 55°C)

Innovative design & technology

- Duplex stainless steel water tank (200 ℓ)
- Durable stainless steel: no need to install an anode and replace it on a regular basis in the case of a magnesium anode, or no electricity consumption in the case of an impressed current anode.

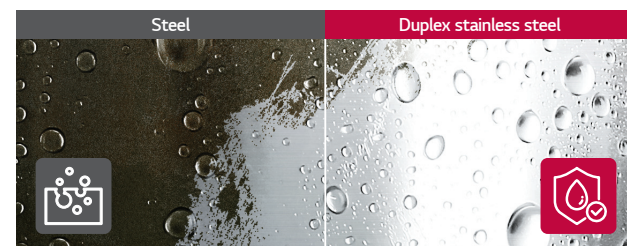

- Internal coil type heat exchanger
- Built-in water flow and pressure sensors to monitor the water circuit in real time
- PWM-pump with option to control by ΔT
- Energy monitoring of estimated power consumption

Control & connectivity

- LG ThinQ Wi-Fi control and monitoring solution
- PV / ESS or smart grid connectivity
- Modbus connectivity without a gateway
- Schedule-based control logic for DHW recirculation pump
- Enhanced 2nd circuit control logic

Model line-up

Category	Unit	Model name	
		Capacity (kW)	
		4.0	6.0
1 Phase model 220 ~ 240 V, 1 Ø, 50 Hz	Outdoor unit	HU041MR U20	HU061MR U20
	Indoor unit	HN0613T NK0	

Seasonal energy

Description		Outdoor unit	HU041MR U20	HU061MR U20
		Indoor unit	HN0613T NK0	
Space heating (according to EN14825)	Average climate water outlet 35°C	SCOP	-	4.65
		Seasonal space heating efficiency (η _s)	%	183
		Seasonal space heating eff. class	-	A+++
	Average climate water outlet 55°C	SCOP	-	3.23
		Seasonal space heating efficiency (η _s)	%	126
		Seasonal space heating eff. class	-	A++
Domestic hot water efficiency (according to EN16147)	Average climate	Declared load profile	-	L
		Water heating efficiency (η _{WH})	%	133
		COP _{DHW}	-	3.15
		Water heating eff. class	-	A+
		Declared load profile	-	L
		Water heating efficiency (η _{WH})	%	160
	Warmer climate	COP _{DHW}	-	3.69
		Water heating eff. class	-	A++
		Declared load profile	-	L
	Colder climate	Water heating efficiency (η _{WH})	%	110
		COP _{DHW}	-	2.54
		Water heating eff. class	-	A

Nominal capacity and nominal power input

Technical specification		OAT ¹⁾	LWT ²⁾	Outdoor unit	HU041MR U20	HU061MR U20
				Indoor unit	NO613T NK0	
Nominal capacity	Heating	7°C	35°C	kW	4.00	6.00
		7°C	55°C	kW	3.70	4.60
		2°C	35°C	kW	3.60	4.80
		-7°C	35°C	kW	4.00	6.00
	Cooling	35°C	18°C	kW	4.00	6.00
		35°C	7°C	kW	4.00	6.00
Nominal power input	Heating	7°C	35°C	kW	0.78	1.21
		7°C	55°C	kW	1.30	1.59
		2°C	35°C	kW	0.96	1.32
	Cooling	-7°C	35°C	kW	1.30	2.01
		35°C	18°C	kW	0.83	1.25
		35°C	7°C	kW	1.18	1.88
COP	Heating	7°C	35°C	W/W	5.10	4.95
		7°C	55°C	W/W	2.85	2.90
		2°C	35°C	W/W	3.75	3.65
		-7°C	35°C	W/W	3.08	2.98
EER	Cooling	35°C	18°C	W/W	4.80	4.80
		35°C	7°C	W/W	3.40	3.20

1) OAT: Outdoor Air Temperature
2) LWT: Leaving Water Temperature

R32 Split 4/6 kW IWT

Product specification (outdoor unit)

Technical specification			Unit	HU041MR U20	HU061MR U20
Operation range (outdoor temp.)	Heating	Min. - Max.	°C DB	-20 - 35	
	Cooling			5 - 48	
Compressor	Type		-	Hermetic sealed twin rotary	
	Type		-	R32	
Refrigerant	GWP (Global Warming Potential)		-	675	
	Precharged amount		g	1,100	
	t-CO ₂ eq		-	0,743	
Piping connections	Outer diameter	Liquid	mm (inch)	Ø 6.35 (1/4)	
		Gas	mm (inch)	Ø 12.7 (1/2)	
	Length	Standard	m	5	
		Max.	m	30	
	Level difference	Max.	m	30	
	Chargeless-pipe length		m	10	
	Additional charging volume		g/m	20	
Rated water flow rate (at LWT 35°C)			l/min	11.5	17.3
Sound power level	Heating	Rated	dB(A)	57	
	Cooling			58	
Sound pressure level (at 1 m)	Heating	Rated	dB(A)	49	
	Cooling			50	
Dimensions	Unit	W x H x D	mm	870 x 650 x 330	
	Weight			kg	44.7
Exterior	Color / RAL code		-	Warm gray / RAL 7044	
	Voltage, phase, frequency		V, Ø, Hz	220-240, 1, 50	
Power supply	Rated	Heating	A	3.5	
	running current			Cooling	A
	Recommended circuit breaker		A		
	Wiring connections	Power supply cable (included earth, H07RN-F)	mm ² x cores	2.5 x 3 C	

Product specification (indoor unit)

Technical specification			Unit	HN0613T NKO
Operation range (Leaving water temperature)	Heating	Min. - Max.	°C DB	15 - 55
	Cooling			5 - 27 (16 - 27) ¹⁾
Domestic hot water tank	DHW			15 - 80 ²⁾
	Volume		l	200
	Material		-	Duplex stainless steel
	Internal thermal protect limit		°C	85
Flow sensor	Measuring range	Min. - Max.	LPM	5 - 80
Water pressure sensor	Measuring range	Min. - Max.	bar (G)	0 - 20
Expansion vessel (heating circuit)	Volume		l	8
	Heating circuit	Upper limit	bar	3
Safety valve	DHW circuit	Upper limit	bar	10
	Refrigerant circuit	Liquid (outside diameter)	mm (inch)	Ø 6.35 (1/4) ³⁾
Piping connections	Gas (outside diameter)		mm (inch)	Ø 12.7 (1/2) ³⁾
		Water circuit	Inlet	inch
	DHW tank water circuit	Outlet	inch	
		Cold inlet	inch	
		Hot outlet	inch	Female G1" according to ISO228-1 (parallel pipe threads)
	Recirculation	inch		
	Sound power level	Heating	Rated	dB(A)
Dimensions	Unit	W x H x D	mm	600 x 1,750 x 660
Weight	Unit		kg	118
Exterior	Color / RAL code		-	Noble white / RAL 9016
	Wiring connections	Power and communication cable (included earth, H07RN-F)	mm ² x cores	0.75 x 4 C
Electric heater	Type		-	Sheath
	No. of heating coil		EA	2
	Capacity combination		kW	3
	Heating step		Step	1
	Power supply		V, Ø, Hz	220-240, 1, 50
	Wiring connections power supply cable (included earth, H07RN-F)		mm ² x cores	2.5 x 3 C
	Rated current		A	13

- 1) When a fan coil unit is not used.
- 2) DHW 50 - 80°C operating is available only when the booster heater is operating.
- 3) When connecting the refrigerant pipe, the adaptors provided with the outdoor unit must be installed on the connection of the indoor unit.

Note

1. Due to our policy of innovation, some specifications may be changed without notification.
2. Wiring cable size must comply with the applicable local and national codes. Especially the power cable and circuit breaker should be selected in accordance with that.
3. Sound power level is measured on the rated condition in accordance with ISO 9614 standard. Sound pressure level is converted from sound power level based on a tonality penalty of 0 dB and installation in free-field. The directivity index (Q) is assumed as 2. Therefore, these values can be increased owing to ambient conditions during operation. Rated sound power level is in accordance with EN12102-1 under condition of EN14825.
4. Performances are in accordance with EN14511 and reflect ErP testing conditions. Above gives the declared values at rated conditions acc. ErP regulation.
 - Rated running current: outdoor Temp. 7°C DB / 6°C WB, LWT 35°C
 - Interconnected pipe length is standard length and difference of elevation (outdoor - indoor unit) is 0 m.
5. This product contains fluorinated greenhouse gases.
6. All installation sites must be equipped with an earth leakage circuit breaker (ELCB).



Performance Table for Heating Operation

Maximum heating capacity (including defrost effect)

HU041MR U20 + HN0613T NK0

Outdoor temperature	LWT 30°C	LWT 35°C	LWT 40°C	LWT 45°C	LWT 50°C	LWT 55°C
	Capacity (kW)					
-20°C DB	4.00	4.00	4.00	4.00	-	-
-15°C DB	4.00	4.00	4.00	4.00	4.00	-
-7°C DB	4.00	4.00	4.00	4.00	4.00	4.00
-4°C DB	4.00	4.00	4.00	4.00	4.00	4.00
-2°C DB	4.00	4.00	4.00	4.00	4.00	4.00
2°C DB	4.00	4.00	4.00	4.00	4.00	4.00
7°C DB	4.00	4.00	4.00	4.00	4.00	4.00
10°C DB	4.00	4.00	4.00	4.00	4.00	4.00
15°C DB	4.00	4.00	4.00	4.00	4.00	4.00
18°C DB	4.00	4.00	4.00	4.00	4.00	4.00
20°C DB	4.00	4.00	4.00	4.00	4.00	4.00
35°C DB	4.00	4.00	4.00	4.00	4.00	4.00

HU061MR U20 + HN0613T NK0

Outdoor temperature	LWT 30°C	LWT 35°C	LWT 40°C	LWT 45°C	LWT 50°C	LWT 55°C
	Capacity (kW)					
-20°C DB	4.92	4.78	4.64	4.50	-	-
-15°C DB	5.56	5.52	5.48	5.44	5.40	-
-7°C DB	6.00	6.00	6.00	6.00	6.00	6.00
-4°C DB	6.00	6.00	6.00	6.00	6.00	6.00
-2°C DB	6.00	6.00	6.00	6.00	6.00	6.00
2°C DB	6.00	6.00	6.00	6.00	6.00	6.00
7°C DB	6.00	6.00	6.00	6.00	6.00	6.00
10°C DB	6.00	6.00	6.00	6.00	6.00	6.00
15°C DB	6.00	6.00	6.00	6.00	6.00	6.00
18°C DB	6.00	6.00	6.00	6.00	6.00	6.00
20°C DB	6.00	6.00	6.00	6.00	6.00	6.00
35°C DB	6.00	6.00	6.00	6.00	6.00	6.00

Note
 1. DB: Dry Bulb Temperature (°C), LWT: Leaving Water Temperature (°C)
 2. Direct interpolation is permissible. Do not extrapolate.
 3. Measuring procedure follows EN-14511.
 • Rated values are based on standard conditions and can be found on specifications.
 • Above table values may not be matched according to installation conditions. Except for rated values, the performance is not guaranteed.
 • The rating might slightly vary depending on test standards or countries.
 4. The shaded areas are not guaranteed continuous operation.

Performance Table for Cooling Operation

Maximum cooling capacity

HU041MR U20 + HN0613T NK0

Outdoor temperature	LWT 7°C	LWT 10°C	LWT 13°C	LWT 15°C	LWT 18°C	LWT 20°C	LWT 22°C
	Capacity (kW)						
10°C DB	4.00	4.00	4.00	4.00	4.00	4.00	4.00
20°C DB	4.00	4.00	4.00	4.00	4.00	4.00	4.00
30°C DB	4.00	4.00	4.00	4.00	4.00	4.00	4.00
35°C DB	4.00	4.00	4.00	4.00	4.00	4.00	4.00
40°C DB	4.00	4.00	4.00	4.00	4.00	4.00	4.00
45°C DB	4.00	4.00	4.00	4.00	4.00	4.00	4.00

HU061MR U20 + HN0613T NK0

Outdoor temperature	LWT 7°C	LWT 10°C	LWT 13°C	LWT 15°C	LWT 18°C	LWT 20°C	LWT 22°C
	Capacity (kW)						
10°C DB	6.00	6.00	6.00	6.00	6.00	6.00	6.00
20°C DB	6.00	6.00	6.00	6.00	6.00	6.00	6.00
30°C DB	6.00	6.00	6.00	6.00	6.00	6.00	6.00
35°C DB	6.00	6.00	6.00	6.00	6.00	6.00	6.00
40°C DB	5.74	5.81	5.87	5.91	6.00	6.00	6.00
45°C DB	5.48	5.61	5.73	5.81	5.94	6.00	6.00

Note
 1. DB: Dry Bulb Temperature (°C), LWT: Leaving Water Temperature (°C)
 2. Direct interpolation is permissible. Do not extrapolate.
 3. Measuring procedure follows EN-14511.
 • Rated values are based on standard conditions and can be found on specifications.
 • Above table values may not be matched according to installation conditions. Except for rated values, the performance is not guaranteed.
 • The rating might slightly vary depending on test standards or countries.
 4. The shaded areas are not guaranteed continuous operation.

Drawings

Category	Unit	Model name	
		Capacity (kW)	
1 Phase model 220 - 240 V, 1 Ø, 50 Hz	Outdoor unit	HU041MR U20	HU061MR U20
	Indoor unit	HN0613T NK0	

HU041MR U20 / HU061MR U20

[Unit: mm]

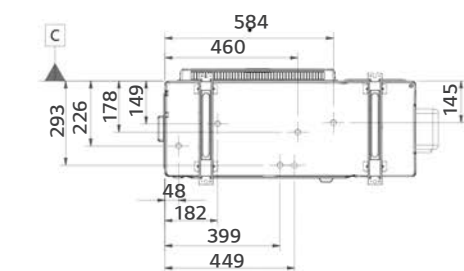
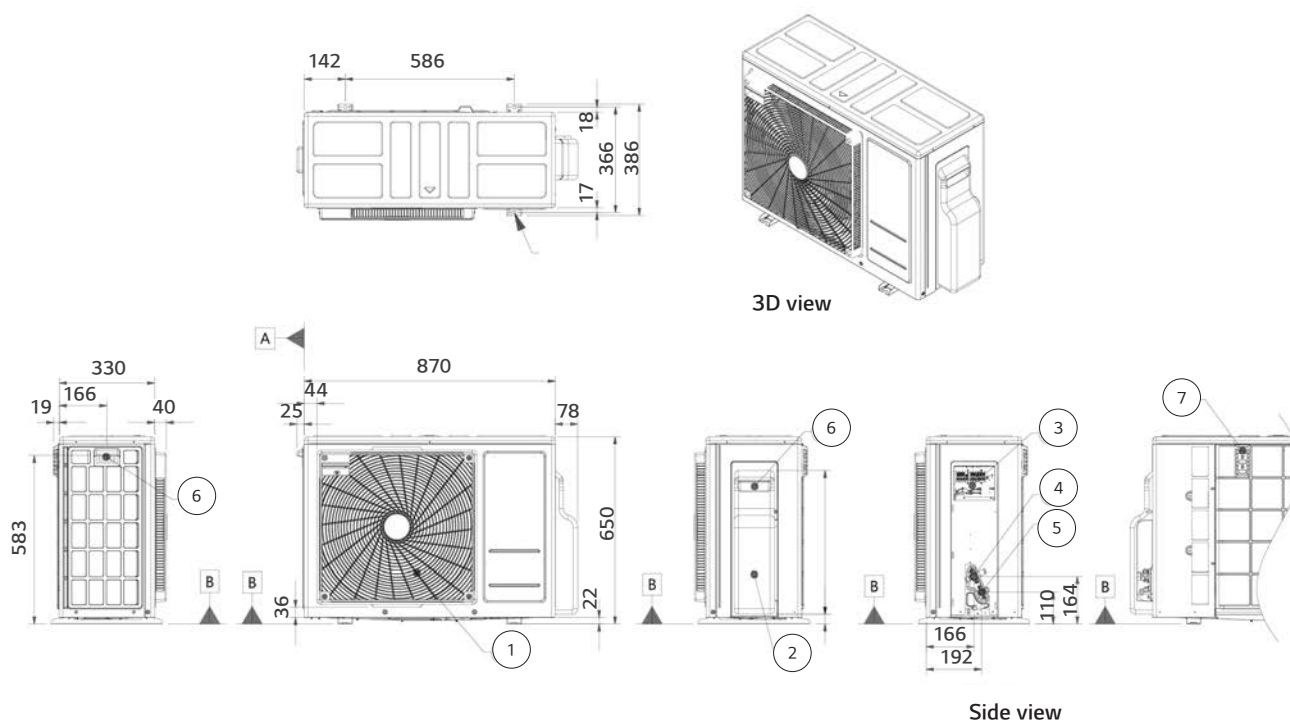

No.	Part name	Description
1	Air outlet	-
2	Control cover & SVC valve cover	-
3	Power and communication cable connection	-
4	Gas pipe connection	Flare joint
5	Liquid pipe connection	Flare joint
6	Handle	-
7	Intake air temperature sensor cover	-

HN0613T NK0

External

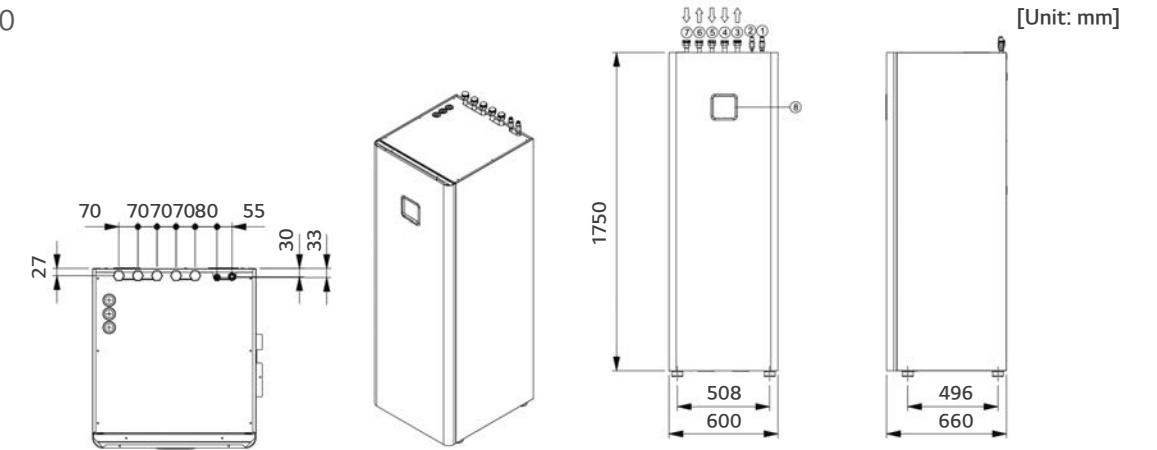

No.	Part name	Description
1	Refrigerant gas pipe	SAE 1/2" ¹⁾
2	Refrigerant liquid pipe	SAE 1/4" ¹⁾
3	Heating circuit outlet pipe	Female G1" according to ISO228-1 (parallel pipe threads)
4	Heating circuit inlet pipe	
5	Domestic cold water inlet pipe	
6	Domestic cold water outlet pipe	
7	DHW re-circulation pipe	
8	Control panel	Built-in remote controller

1) When connecting the refrigerant pipe, the adaptors provided with the outdoor unit must be installed on the connection of the indoor units.

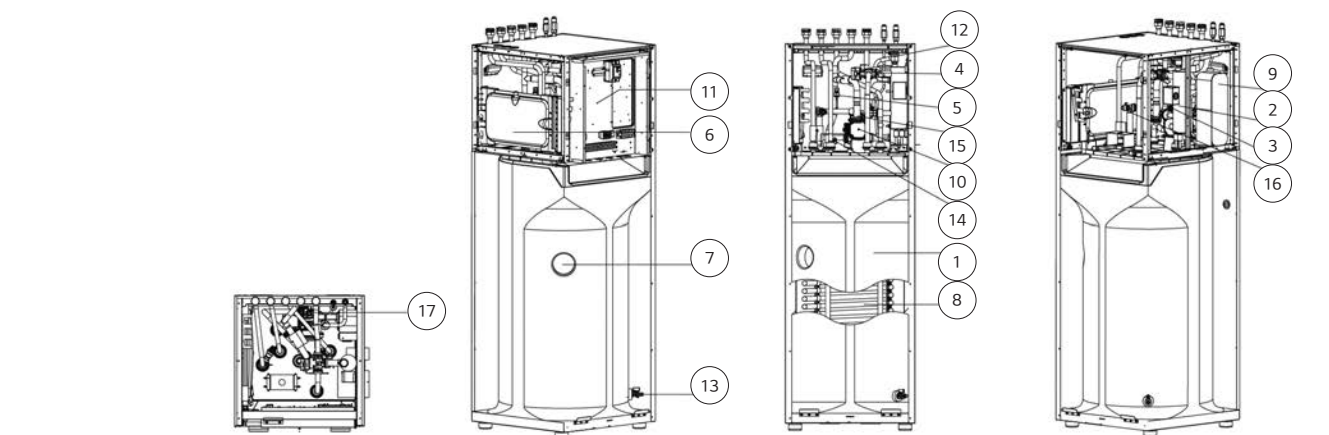

No.	Part name	Description
1	DHW tank	Domestic hot water tank (200 l)
2	Heater	Electric heater (3 kW)
3	Flow sensor	Flow metering sensor
4	3 way valve	For DHW / heating
5	Pressure sensor	Pressure sensor
6	Expansion vessel	8 l for Heating circuit
7	DHW tank sensor	Temperature sensor
8	Heat exchanger 1	Coil heat exchange (water / DHW)
9	Heat exchanger 2	Plate heat exchange (ref. / Water)

No.	Part name	Description
10	Water pump	Main circulation pump
11	Control box	PCB/A and terminal blocks
12	Air vent	For air purging
13	Drain cock 1	Valve for DHW tank drain
14	Drain cock 2	Valve for water circuit drain
15	Strainer	For water circuit
16	Safety valve	For DHW (10 bar)
17	Safety valve	For water circuit (3 bar)

THERMA V™ R32

R32 SPLIT 5/7/9 kW IWT

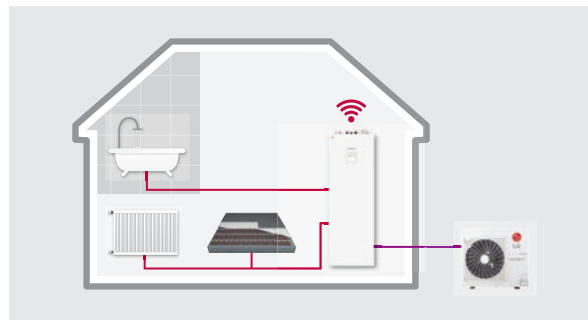
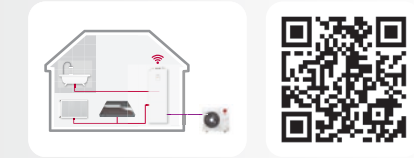

Excellent performance & efficiency

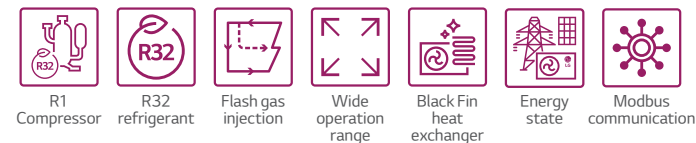

User convenience

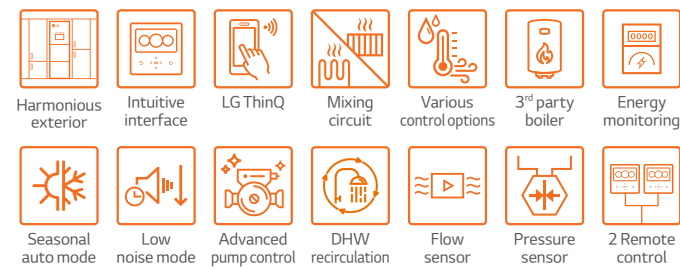

Easy Installation & Maintenance

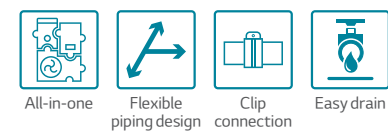

* Detailed description for each function is presented on page 44 – 54.

Energy Label

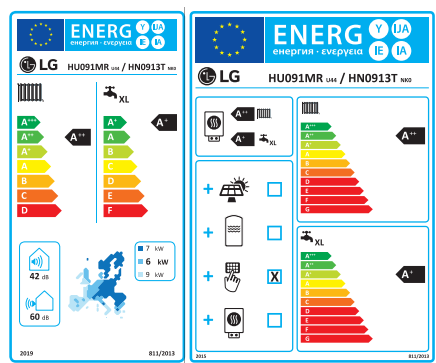

* 9 kW 1 Ø model.
* A+++ to D scale.

R32 Split IWT Introduction

LG Therma V Split IWT with an integrated indoor hot water tank – a domestic hot water supply, space heating and cooling solution – has reached a new era of innovation. A stainless steel water tank reduces the risk of corrosion, while an internal coil type heat exchanger contributes to higher efficiency. Compact and lightweight components allow quicker and easier installation, with various advanced control options providing for user convenience.

The outdoor unit is on offer in 4/6 kW and 5/7/9 kW capacity range and R32 Split 5/7/9 kW model is suitable for both new build and renovation projects.

Key Components

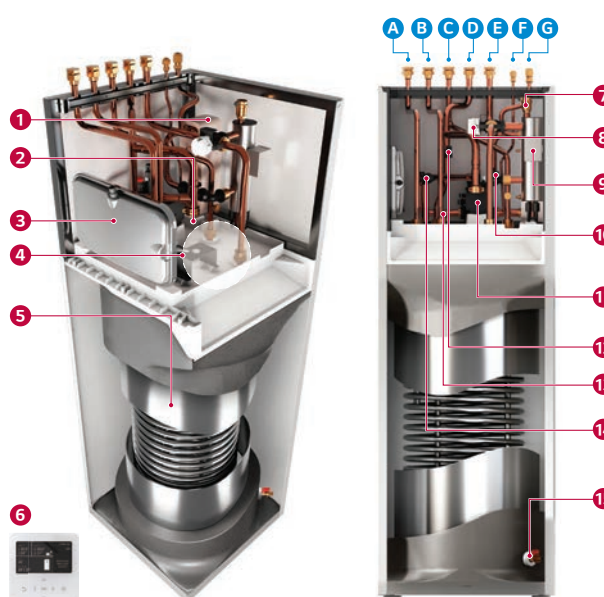

Components

- 1 Plate heat exchanger (ref. / water)
- 2 Strainer
- 3 Expansion tank for heating (8 ℓ)
- 4 Reserved space for DHW expansion tank
- 5 DHW storage tank (stainless steel, 200 ℓ) with internal coil type heat exchanger
- 6 Standard III remote controller (attached on front panel)
- 7 Air vent valve
- 8 3 way diverting valve (DC)
- 9 Electric back-up heater (3 kW)
- 10 Water flow sensor
- 11 Main water pump with air vent and safety valve (water circuit, 3 bar)
- 12 Water pressure sensor
- 13 Drain valve for water circuit
- 14 Safety valve (DHW tank, 10 bar)
- 15 Drain valve for DHW tank

Connections

- A DHW recirculation pipe (female G1" *)
- B Domestic hot water outlet pipe (female G1" *)
- C Domestic cold water inlet pipe (female G1" *)
- D Heating circuit inlet pipe (female G1" *)
- E Heating circuit outlet pipe (female G1" *)
- F Refrigerant liquid pipe (SAE 3/8")
- G Refrigerant gas pipe (SAE 5/8")

* According to ISO 228-1 (parallel pipe threads)

All-in-One Solution: Integrated Water Tank Type

Therma V R32 Split IWT is the perfect space-saving solution for residential application thanks to its fully integrated hot water tank. Unlike in the case of typical separate installation, in this all-in-one solution hydronic components and Domestic Hot Water (DHW) are pre-wired, which requires reduced installation time and saves valuable living space. Therma V R32 Split IWT is easy to set up and operate while it demonstrates outstanding reliability and efficiency.



Conventional

LG Therma V R32 Split IWT
(less installation space required)

Energy States Interlock

Therma V R32 Split IWT provides an energy state interlock function enabling customers to use their own renewable energy as much as possible. It can shift set points depending on input signal from the Energy Storage System (ESS) or any other third-party device using Modbus or Digital 230 V inputs.

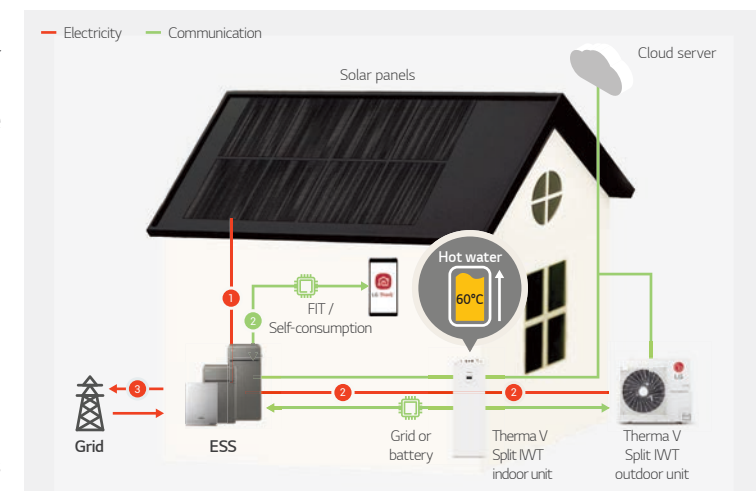

- 1) Energy is generated from solar panels and sent to your battery.
- 2) Once the battery is fully charged, the surplus energy from the ESS will heat the water tank. The user gets to monitor the status with the LG ThinQ app.
- 3) Once the water is heated, the user can choose to sell surplus energy to the grid.

Easy Draining System

It is convenient for maintenance or moving as the water inside can be easily drained through the built-in drain valve.



DHW Recirculation Pump Control

Therma V can be connected to the DHW recirculation pump, which can then be managed via the scheduling function. When a user opens the faucet, hot water is immediately accessible thanks to the DHW recirculating function. This feature also has the added advantage of preventing Legionella growth in the hot water pipe.



R32 Split IWT (Integrated Water Tank)



Indoor unit
HN0913T NK0
Outdoor unit
HU051MR U44
HU071MR U44
HU091MR U44



Features

All-in-one integration

- Quick and easy installation
- DHW tank and hydronic component integration
- Integrated 3 kW backup heater and expansion tank for heating (8 ℓ)

Enhanced installation flexibility

- Refrigerant pipes connect IDU & ODU
- Light weight and compact size indoor unit
- Max. 50 m refrigerant piping and 3-way piping connection availability

High efficiency & wide operational range

- R32 Refrigerant with low GWP
- SCOP up to 4.65 / 3.23 (low temp. / mid temp. application): **A+++ / A++**
- Water heating efficiency 133 % (5,7 kW, profile L) / 140 % (9 kW, profile XL): **A+**
- COP up to 4.90 (outdoor air 7°C / leaving water 35°C)
- Operation range (ambient: -25 ~ 35°C / water side: 15 ~ 65°C)

Innovative design & technology

- Duplex stainless steel water tank (200 ℓ)
- Durable stainless steel: no need to install an anode and replace it on a regular basis in the case of a magnesium anode, or no electricity consumption in the case of an impressed current anode.



- Internal coil type heat exchanger
- Built-in water flow and pressure sensors to monitor the water circuit in real time
- PWM-pump with option to control by ΔT
- Energy monitoring of estimated power consumption

Control & connectivity

- LG ThinQ Wi-Fi control and monitoring solution
- PV / ESS or smart grid connectivity
- Modbus connectivity without a gateway
- Schedule-based control logic for DHW recirculation pump
- Enhanced 2nd circuit control logic

Model line-up

Category	Unit	Model name		
		Capacity (kW)		
		5.0	7.0	9.0
1 Phase model 220 ~ 240 V, 1 Ø, 50 Hz	Outdoor unit	HU051MR U44	HU071MR U44	HU091MR U44
	Indoor unit	HN0913T NK0		

Seasonal energy

Description		Outdoor unit	HU051MR U44	HU071MR U44	HU091MR U44
		Indoor unit	HN0913T NK0		
Space heating (according to EN14825)	Average climate water outlet 35°C	SCOP	-	4.65	4.65
		Seasonal space heating efficiency (η _s)	%	183	183
		Seasonal space heating eff. Class	-	A+++	A+++
	Average climate water outlet 55°C	SCOP	-	3.23	3.23
		Seasonal space heating efficiency (η _s)	%	126	126
		Seasonal space heating eff. class	-	A++	A++
Domestic hot water efficiency (according to EN16147)	Average climate	Declared load profile	-	L	XL
		Water heating efficiency (η _{WH})	%	133	133
		COP _{DHW}	-	3.15	3.40
		Water heating eff. class	-	A+	A+
		Declared load profile	-	L	XL
		Water heating efficiency (η _{WH})	%	160	170
	Warmer climate	COP _{DHW}	-	3.69	4.10
		Water heating eff. class	-	A++	A++
		Declared load profile	-	L	XL
	Colder climate	Water heating efficiency (η _{WH})	%	110	115
		COP _{DHW}	-	2.54	2.65
		Water heating eff. class	-	A	A

Nominal capacity and nominal power input

Description		OAT ¹⁾ (DB)	LWT ²⁾ (DB)	Outdoor unit	HU051MR U44	HU071MR U44	HU091MR U44
				Indoor unit	HN0913T NK0		
Nominal capacity	Heating	7°C	35°C	kW	5.50	7.00	9.00
		7°C	55°C		5.50	5.50	5.50
		2°C	35°C		3.30	4.20	5.40
	Cooling	35°C	18°C		5.50	7.00	9.00
		35°C	7°C		5.50	7.00	9.00
		7°C	35°C		1.12	1.43	1.94
Nominal power input	Heating	7°C	55°C	kW	2.04	2.04	2.04
		2°C	35°C		0.94	1.20	1.54
		35°C	18°C		1.20	1.56	2.14
	Cooling	35°C	7°C		1.96	2.59	3.46
		7°C	35°C		4.90	4.90	4.65
		7°C	55°C		2.70	2.70	2.70
COP	Heating	2°C	35°C	W/W	3.52	3.51	3.50
		35°C	18°C		4.60	4.50	4.20
		35°C	7°C		2.80	2.70	2.60

1) OAT: Outdoor Air Temperature
2) LWT: Leaving Water Temperature

R32 Split 5/7/9 kW IWT (Integrated Water Tank)

Product specification (outdoor unit)

Technical specification			Unit	HU051MR U44	HU071MR U44	HU091MR U44
Operation range (outdoor temp.)	Heating	Min. - Max.	°C DB	-25 - 35		
	Cooling			5 - 48		
Compressor	Type	-				
		Hermetic sealed scroll				
Refrigerant	Type	R32				
	GWP (Global Warming Potential)	675				
	Precharged amount	g				
	t-CO ₂ , eq	1,013				
Piping connections	Outer diameter	Liquid	mm (inch)	Ø 9.52 (3/8)		
		Gas	mm (inch)	Ø 15.88 (5/8)		
	Length	Standard	m	5		
		Max.	m	50		
	Level difference	Max.	m	30		
	Chargeless-pipe length		m	10		
	Additional charging volume		g/m	40		
Rated water flow rate (at LWT 35°C)		ℓ/min	15.8	20.1	25.9	
Sound power level	Heating	Rated	dB(A)			
Sound pressure level (at 1 m)	Heating	Rated	dB(A)			
Dimensions	Unit	W x H x D	mm			
	Unit		kg			
Exterior	Color / RAL code		Warm gray / RAL 7044			
	Voltage, phase, frequency		V, Ø, Hz			
Power supply	Rated running current	Heating	A	5.0	6.3	8.6
		Cooling	A	5.3	6.9	9.5
	Recommended circuit breaker		A	20	25	30
	Wiring connections	Power supply cable (included earth, H07RN-F)	mm ² x cores	4.0 x 3 C		

Product specification (indoor unit)

Technical specification			Unit	HN0913T NK0	
Operation range (leaving water temperature)	Heating	Min. - Max.	°C DB	15 - 65	
	Cooling			5 - 27 (16 - 27) ¹⁾	
Domestic hot water tank	DHW			15 - 80 ²⁾	
	Volume		ℓ	200	
	Material			Duplex stainless steel	
	Internal thermal protect limit		°C	85	
Flow sensor	Measuring range	Min. - Max.	LPM	5 - 80	
Water pressure sensor	Measuring range	Min. - Max.	bar (G)	0 - 20	
Expansion vessel (heating circuit)	Volume		ℓ	8	
Safety valve	Heating circuit	Upper limit	bar	3	
	DHW circuit	Upper limit	bar	10	
Piping connections	Refrigerant circuit	Liquid (outside diameter)	mm (inch)	Ø 9.52 (3/8)	
		Gas (outside diameter)	mm (inch)	Ø 15.88 (5/8)	
	Water circuit	Inlet	inch	Female G1" according to ISO228-1 (parallel pipe threads)	
		Outlet	inch		
	DHW tank water circuit	Cold inlet	inch	Female G1" according to ISO228-1 (parallel pipe threads)	
Hot outlet		inch			
Recirculation		inch			
Sound power level	Heating	Rated	dB(A)	42	
Dimensions	Unit	W x H x D	mm	600 x 1,750 x 660	
Weight	Unit		kg	118	
Exterior	Color / RAL code			White / RAL 9016	
Wiring connections	Power and communication cable (included earth, H07RN-F)		mm ² x cores	0.75 x 4 C	
	Type			Sheath	
Electric heater	No. of heating coil		EA	2	
	Capacity combination		kW	3	
	Heating step		Step	1	
	Power supply		V, Ø, Hz	220-240, 1, 50	
	Wiring connections power supply cable (included earth, H07RN-F)		mm ² x cores		2.5 x 3 C
	Rated current		A		13.0

1) When a fan coil unit is not used.

2) DHW 55 - 80°C operating is available only when the electric heater is operating.

Note

1. Due to our policy of innovation, some specifications may be changed without notification.

2. Wiring cable size must comply with the applicable local and national codes.

Especially the power cable and circuit breaker should be selected in accordance with that.

3. Sound power level is measured on the rated condition in accordance with ISO 9614 standard.

Sound pressure level is converted from sound power level based on a tonality penalty of 0 dB and installation in free-field. The directivity index (Q) is assumed as 2.

Therefore, these values can be increased owing to ambient conditions during operation.

Rated sound power level is in accordance with EN12102-1 under condition of EN14825.

4. Performances are in accordance with EN14511 and reflect ErP testing conditions. Above gives the declared values at rated conditions acc. ErP regulation

• Rated running current: Outdoor Temp. 7°C DB / 6°C CWB, LWT 35°C

• Interconnected pipe length is standard length and difference of elevation (outdoor - indoor unit) is 0 m.

5. This product contains fluorinated greenhouse gases.

6. All installation sites must be equipped with an earth leakage circuit breaker (ELCB).



Performance Table for Heating Operation

Maximum heating capacity (including defrost effect)

HU051MR U44 + HN0913T NKO

Outdoor temperature	LWT 30°C	LWT 35°C	LWT 40°C	LWT 45°C	LWT 50°C	LWT 55°C	LWT 60°C	LWT 65°C
	Capacity (kW)							
-25°C DB	4.02	3.90	3.78	3.66	-	-	-	-
-20°C DB	4.64	4.51	4.38	4.26	4.13	-	-	-
-15°C DB	5.26	5.12	4.99	4.85	4.72	4.58	-	-
-7°C DB	5.50	5.50	5.50	5.50	5.50	5.50	5.50	-
-4°C DB	5.50	5.50	5.50	5.50	5.50	5.50	5.50	-
-2°C DB	5.50	5.50	5.50	5.50	5.50	5.50	5.50	-
2°C DB	5.50	5.50	5.50	5.50	5.50	5.50	5.50	5.50
7°C DB	5.50	5.50	5.50	5.50	5.50	5.50	5.50	5.50
10°C DB	5.50	5.50	5.50	5.50	5.50	5.50	5.50	5.50
15°C DB	5.50	5.50	5.50	5.50	5.50	5.50	5.50	5.50
18°C DB	5.50	5.50	5.50	5.50	5.50	5.50	5.50	5.50
20°C DB	5.50	5.50	5.50	5.50	5.50	5.50	5.50	5.50
35°C DB	5.50	5.50	5.50	5.50	5.50	5.50	5.50	5.50

HU071MR U44 + HN0913T NKO

Outdoor temperature	LWT 30°C	LWT 35°C	LWT 40°C	LWT 45°C	LWT 50°C	LWT 55°C	LWT 60°C	LWT 65°C
	Capacity (kW)							
-25°C DB	6.40	6.20	6.00	5.80	-	-	-	-
-20°C DB	7.23	7.00	6.77	6.54	6.31	-	-	-
-15°C DB	8.06	7.80	7.54	7.28	7.02	7.10	-	-
-7°C DB	9.00	9.00	9.00	9.00	9.00	9.00	8.60	-
-4°C DB	9.00	9.00	9.00	9.00	9.00	9.00	9.00	-
-2°C DB	9.00	9.00	9.00	9.00	9.00	9.00	9.00	-
2°C DB	9.00	9.00	9.00	9.00	9.00	9.00	9.00	9.00
7°C DB	9.00	9.00	9.00	9.00	9.00	9.00	9.00	9.00
10°C DB	9.00	9.00	9.00	9.00	9.00	9.00	9.00	9.00
15°C DB	9.00	9.00	9.00	9.00	9.00	9.00	9.00	9.00
18°C DB	9.00	9.00	9.00	9.00	9.00	9.00	9.00	9.00
20°C DB	9.00	9.00	9.00	9.00	9.00	9.00	9.00	9.00
35°C DB	9.00	9.00	9.00	9.00	9.00	9.00	9.00	7.95

HU091MR U44 + HN0913T NKO

Outdoor temperature	LWT 30°C	LWT 35°C	LWT 40°C	LWT 45°C	LWT 50°C	LWT 55°C	LWT 60°C	LWT 65°C
	Capacity (kW)							
-25°C DB	6.40	6.20	6.00	5.80	-	-	-	-
-20°C DB	7.23	7.00	6.77	6.54	6.31	-	-	-
-15°C DB	8.06	7.80	7.54	7.28	7.02	7.10	-	-
-7°C DB	9.00	9.00	9.00	9.00	9.00	9.00	8.60	-
-4°C DB	9.00	9.00	9.00	9.00	9.00	9.00	9.00	-
-2°C DB	9.00	9.00	9.00	9.00	9.00	9.00	9.00	-
2°C DB	9.00	9.00	9.00	9.00	9.00	9.00	9.00	9.00
7°C DB	9.00	9.00	9.00	9.00	9.00	9.00	9.00	9.00
10°C DB	9.00	9.00	9.00	9.00	9.00	9.00	9.00	9.00
15°C DB	9.00	9.00	9.00	9.00	9.00	9.00	9.00	9.00
18°C DB	9.00	9.00	9.00	9.00	9.00	9.00	9.00	9.00
20°C DB	9.00	9.00	9.00	9.00	9.00	9.00	9.00	9.00
35°C DB	9.00	9.00	9.00	9.00	9.00	9.00	9.00	7.95

Note
 1. DB: Dry Bulb Temperature (°C), LWT: Leaving Water Temperature (°C)
 2. Direct interpolation is permissible. Do not extrapolate.
 3. Measuring procedure follows EN-14511.
 • Rated values are based on standard conditions and can be found on specifications.
 • Above table values may not be matched according to installation conditions. Except for rated values, the performance is not guaranteed.
 • The rating might slightly vary depending on test standards or countries.
 4. The shaded areas are not guaranteed continuous operation.

Performance Table for Cooling Operation

Maximum cooling capacity

HU051MR U44 + HN0913T NKO

Outdoor temperature	LWT 7°C	LWT 10°C	LWT 13°C	LWT 15°C	LWT 18°C	LWT 20°C	LWT 22°C
	Capacity (kW)						
10°C DB	5.50	5.50	5.50	5.50	5.50	5.50	5.50
20°C DB	5.50	5.50	5.50	5.50	5.50	5.50	5.50
30°C DB	5.50	5.50	5.50	5.50	5.50	5.50	5.50
35°C DB	5.50	5.50	5.50	5.50	5.50	5.50	5.50
40°C DB	5.32	5.34	5.35	5.37	5.38	5.40	5.41
45°C DB	5.13	5.17	5.21	5.23	5.27	5.29	5.32

HU071MR U44 + HN0913T NKO

Outdoor temperature	LWT 7°C	LWT 10°C	LWT 13°C	LWT 15°C	LWT 18°C	LWT 20°C	LWT 22°C
	Capacity (kW)						
10°C DB	7.00	7.00	7.00	7.00	7.00	7.00	7.00
20°C DB	7.00	7.00	7.00	7.00	7.00	7.00	7.00
30°C DB	7.00	7.00	7.00	7.00	7.00	7.00	7.00
35°C DB	7.00	7.00	7.00	7.00	7.00	7.00	7.00
40°C DB	6.50	6.63	6.81	7.00	7.00	7.00	7.00
45°C DB	6.43	6.48	6.63	6.66	6.70	6.74	6.77

HU091MR U44 + HN0913T NKO

Outdoor temperature	LWT 7°C	LWT 10°C	LWT 13°C	LWT 15°C	LWT 18°C	LWT 20°C	LWT 22°C
	Capacity (kW)						
10°C DB	9.00	9.00	9.00	9.00	9.00	9.00	9.00
20°C DB	9.00	9.00	9.00	9.00	9.00	9.00	9.00
30°C DB	9.00	9.00	9.00	9.00	9.00	9.00	9.00
35°C DB	9.00	9.00	9.00	9.00	9.00	9.00	9.00
40°C DB	8.10	8.10	8.70	9.00	9.00	9.00	9.00
45°C DB	7.50	7.70	7.80	7.90	8.00	8.10	8.20

Note
 1. DB: Dry Bulb Temperature (°C), LWT: Leaving Water Temperature (°C)
 2. Direct interpolation is permissible. Do not extrapolate.
 3. Measuring procedure follows EN-14511.
 • Rated values are based on standard conditions and can be found on specifications.
 • Above table values may not be matched according to installation conditions. Except for rated values, the performance is not guaranteed.
 • The rating might slightly vary depending on test standards or countries.
 4. The shaded areas are not guaranteed continuous operation.

Drawings

Category	Unit	Model name		
		Capacity (kW)		
		5.0	7.0	9.0
1 Phase model 220 - 240 V, 1 Ø, 50 Hz	Outdoor unit	HU051MR U44	HU071MR U44	HU091MR U44
	Indoor unit	HN0913T NKO		

HU051MR U44 / HU071MR U44 / HU091MR U44

[Unit: mm]

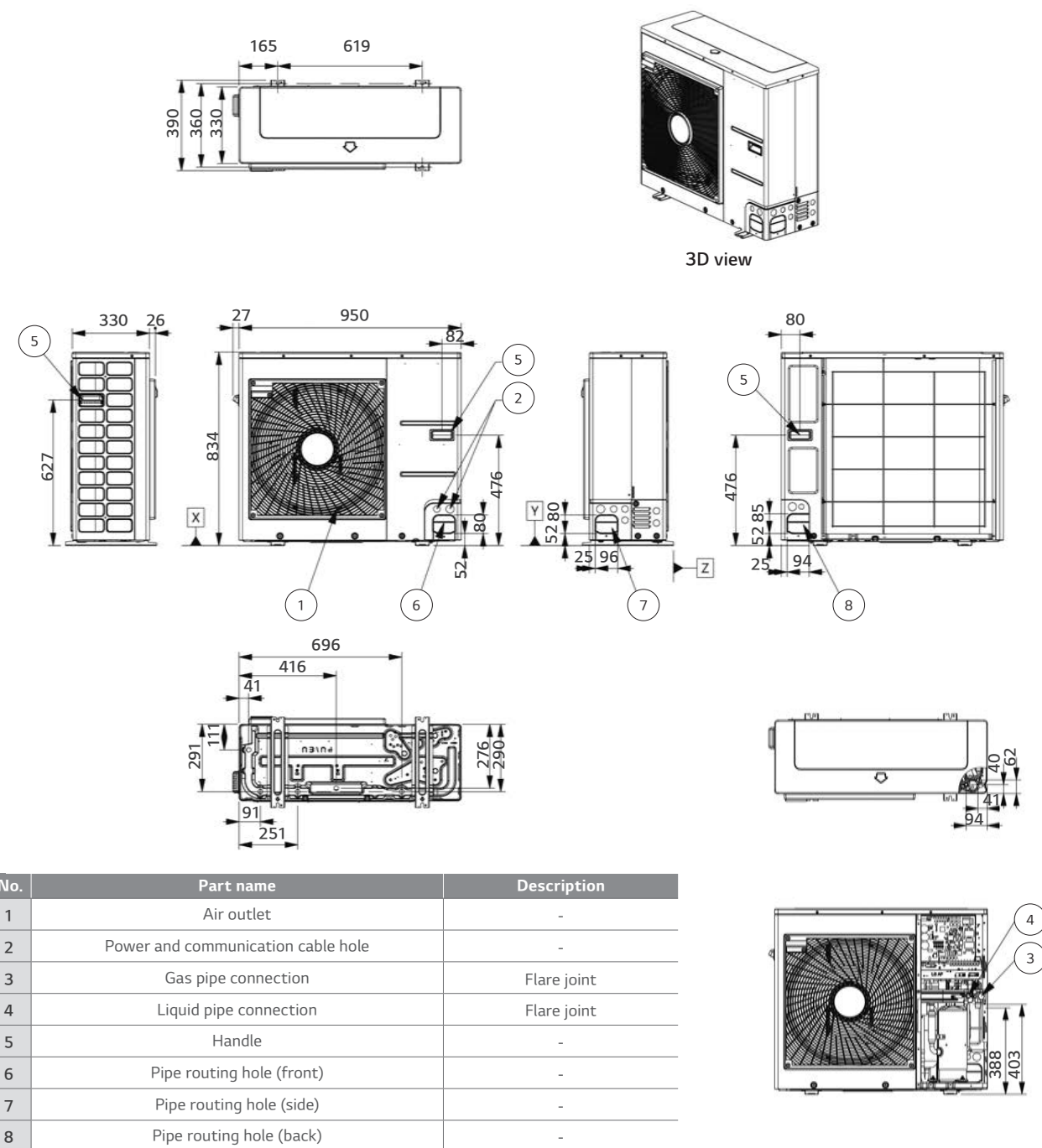

HN0913T NKO

External

[Unit: mm]

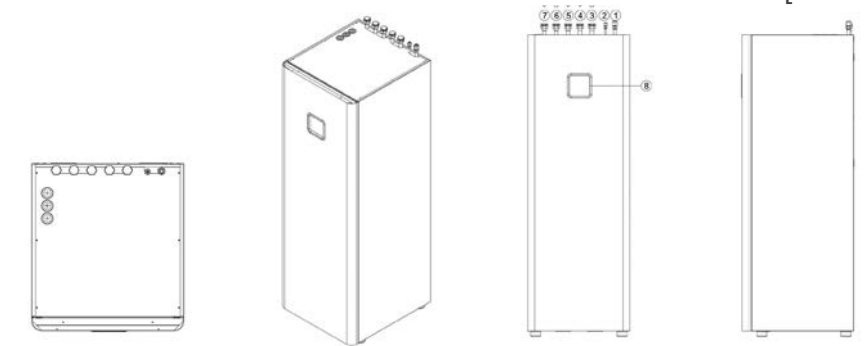

No.	Part name	Description
1	Refrigerant gas pipe	SAE 5/8"
2	Refrigerant liquid pipe	SAE 3/8"
3	Heating circuit outlet pipe	Female G1" according to ISO228-1 (parallel pipe threads)
4	Heating circuit inlet pipe	
5	Domestic cold water inlet pipe	
6	Domestic cold water outlet pipe	
7	DHW re-circulation pipe	
8	Control panel	Built-in remote controller

Internal

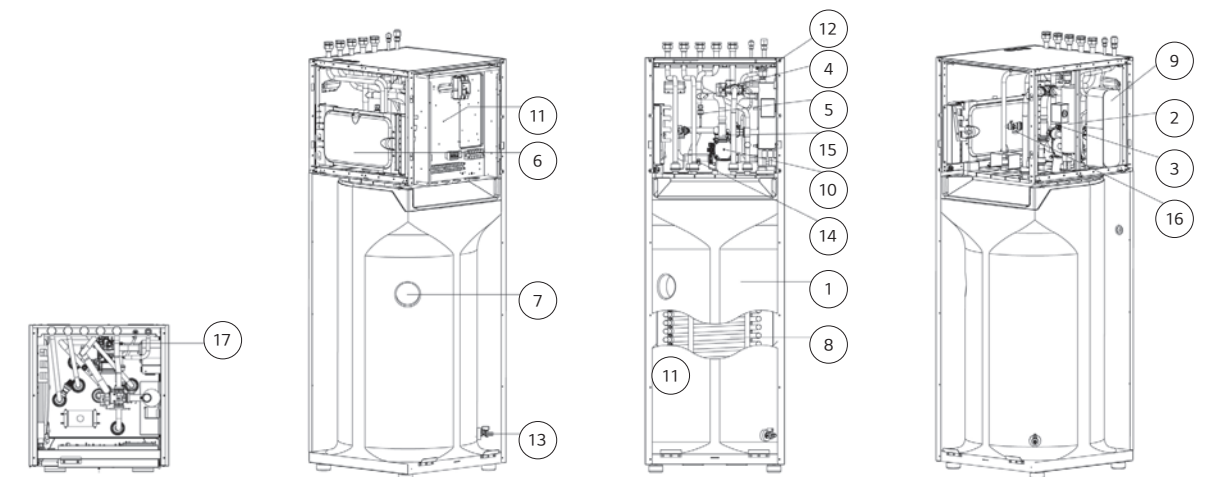

No.	Part name	Description
1	DHW tank	Domestic hot water tank (200 l)
2	Heater	Electric heater (3 kW)
3	Flow sensor	Flow metering sensor
4	3 way valve	For DHW / heating
5	Pressure sensor	Pressure sensor
6	Expansion vessel	8 l for heating circuit
7	DHW tank sensor	Temperature sensor
8	Heat exchanger 1	Coil heat exchange (water / DHW)
9	Heat exchanger 2	Plate heat exchange (ref. / water)

No.	Part name	Description
10	Water pump	Main circulation pump
11	Control box	PCB'A and terminal blocks
12	Air vent	For air purging
13	Drain cock 1	Valve for DHW tank drain
14	Drain cock 2	Valve for water circuit drain
15	Strainer	For water circuit
16	Safety valve	For DHW (10 bar)
17	Safety valve	For water circuit (3 bar)



THERMA V™ R410A SPLIT HYDRO BOX

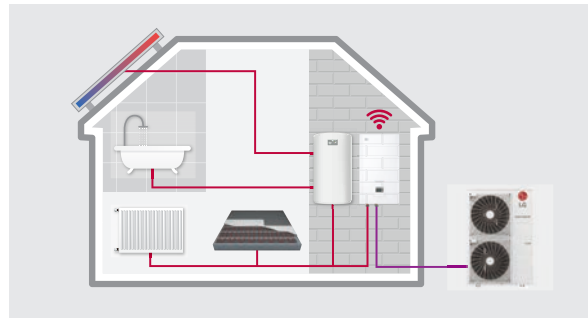
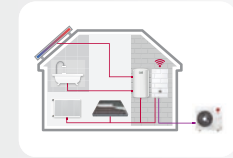

Energy Label

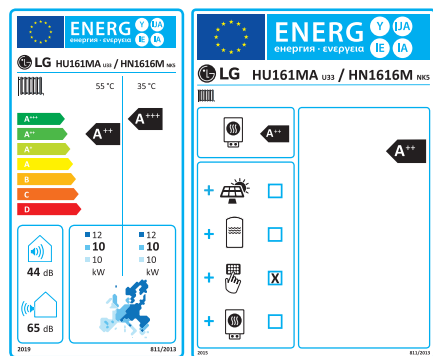

* 16 kW 1 Ø model.
* A+++ to D scale.

Excellent performance & efficiency



User convenience

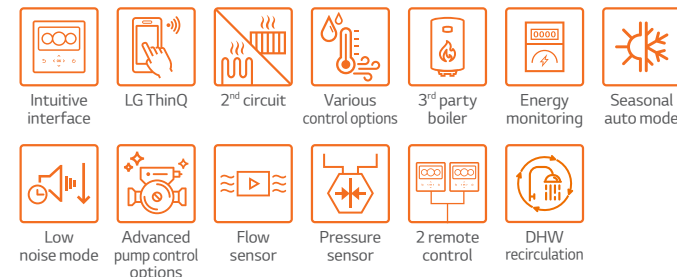

Easy installation & maintenance

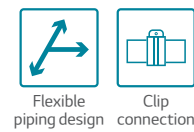

* Detailed description for each function is presented on page 44 – 54.



R410A Split Hydro Box Introduction

The LG Therma V R410A Split Hydro Box is a hydro box type comprising a separate indoor and outdoor unit, which are connected by refrigerant piping. Hydronic components such as a plate heat exchanger, an expansion tank and a water pump are located within the indoor unit, making the unit capable of withstanding freezing outside ambient temperatures.

Key Components



Flexible Refrigerant Piping Design

Installation flexibility is enabled by Therma V Split's long pipe length (up to 50 m) and the fact that the refrigerant piping can be connected in three directions: front, side and rear.

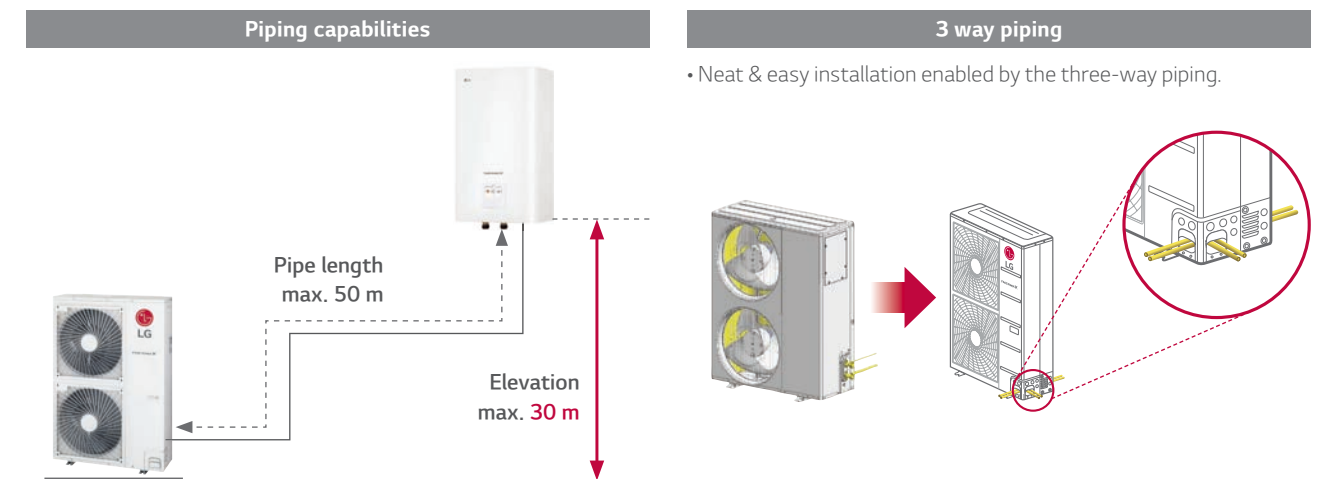

R410A Split Hydro Box



Indoor unit

HN1616M NK5
HN1636M NK5

Outdoor unit

HU121MA U33
HU141MA U33
HU161MA U33
HU123MA U33
HU143MA U33
HU163MA U33



Features

- Refrigerant pipes connect IDU & ODU
- SCOP up to 4.65 (average climate / low temp. application): **A+++**
SCOP up to 3.37 (average climate / mid temp. application): **A++**
- COP up to 4.55 (outdoor air 7°C / leaving water 35°C)
- 100% heating capacity at -7°C OAT (@ LWT 35°C)
- Wide operation range (ambient: -25 ~ 35°C / water side: 15 ~ 57°C)
- Built-in water flow & pressure sensors to monitor real-time water circuit
- R1 Compressor
- Gold Fin heat exchanger
- LG ThinQ
- Keymark / MCS / Eurovent certification

* EHPA label under development

Model line-up

Category	Unit	Model name		
		Capacity (kW)		
		12.0	14.0	16.0
1 Phase model 220 - 240 V, 1 Ø, 50 Hz	Outdoor unit	HU121MA U33	HU141MA U33	HU161MA U33
	Indoor unit	HN1616M NK5		
3 Phase model 380 - 415 V, 3 Ø, 50 Hz	Outdoor unit	HU123MA U33	HU143MA U33	HU163MA U33
	Indoor unit	HN1636M NK5		

Seasonal energy

Description		Outdoor unit	HU121MA U33 (1 Ø)	HU141MA U33 (1 Ø)	HU161MA U33 (1 Ø)	
			HU123MA U33 (3 Ø)	HU143MA U33 (3 Ø)	HU163MA U33 (3 Ø)	
			Indoor unit			
Space heating (according to EN14825)	Average climate water outlet 35°C	SCOP	-	4.65	4.61	4.56
		Seasonal space heating efficiency (η _s)	%	183	182	179
		Seasonal space heating eff. class (A+++ to D scale)	-	A+++	A+++	A+++
	Average climate water outlet 55°C	SCOP	-	3.36	3.37	3.32
		Seasonal space heating efficiency (η _s)	%	131	132	130
		Seasonal space heating eff. class (A+++ to D scale)	-	A++	A++	A++

Nominal capacity and nominal power input

Description		OAT ¹⁾ (DB)	LWT ²⁾ (DB)	Outdoor unit	HU121MA U33 (1 Ø)	HU141MA U33 (1 Ø)	HU161MA U33 (1 Ø)
					HU123MA U33 (3 Ø)	HU143MA U33 (3 Ø)	HU163MA U33 (3 Ø)
					Indoor unit		
Nominal capacity	Heating	7°C	35°C	kW	12.00	14.00	16.00
		7°C	55°C		11.00	11.50	12.00
		2°C	35°C		11.00	12.00	13.80
	Cooling	35°C	18°C		10.40	12.00	13.00
		35°C	7°C		7.94	8.50	8.92
		7°C	35°C		2.64	3.17	3.76
Nominal power input	Heating	7°C	55°C	kW	4.31	4.51	4.71
		2°C	35°C		3.04	3.32	3.83
		35°C	18°C		2.60	3.08	3.60
	Cooling	35°C	7°C		2.66	3.02	2.53
		7°C	35°C		4.55	4.41	4.26
		7°C	55°C		2.55	2.55	2.55
COP	Heating	2°C	35°C	W/W	3.62	3.61	3.60
		35°C	18°C		4.00	3.90	3.61
		35°C	7°C		2.98	2.81	3.53

1) OAT: Outdoor Air Temperature
2) LWT: Leaving Water Temperature

R410A Split Hydro Box

Product specification (outdoor unit)

Technical specification			Unit	HU121MA U33	HU141MA U33	HU161MA U33	HU123MA U33	HU143MA U33	HU163MA U33
Operation range (outdoor temp.)	Heating	Min. – Max.	°C DB	-25 – 35					
	Cooling								
Compressor	Quantity	1							
	Type	Hermetic sealed scroll							
Refrigerant	Type	R410A							
	GWP (Global Warming Potential)	2,088							
	Precharged amount	g 2,500							
	t-CO ₂ eq	5,219							
Piping connections	Outside diameter	Gas	mm (inch)	Ø 15.88 (5/8)					
		Liquid	mm (inch)	Ø 9.52 (3/8)					
	Length	Standard	m	7.5					
		Max.	m	50					
	Level difference	Max.	m	30					
	Chargeless-pipe length	m 7.5							
Additional charging volume	g/m 40								
Rated water flow rate (at LWT 35°C)			LPM	34.5	40.3	46.0	34.5	40.3	46.0
Sound power level	Heating	Rated	dB(A)	63	64	65	63	64	65
	Cooling			55	56	57	55	56	57
Sound pressure level (at 1 m)	Heating	Rated	dB(A)	55	56	57	55	56	57
Dimensions	Unit	W x H x D	mm	950 x 1,380 x 330					
Weight	Unit			84.8			85.4		
Exterior	Color / RAL code		-	Warm gray / RAL 7044					
Power supply	Voltage, phase, frequency		V, Ø, Hz	220-240, 1, 50			380-415, 3, 50		
	Rated running current	Heating	A	11.5	13.8	16.3	6.6	8.0	9.4
		Cooling	A	11.3	13.4	15.7	6.5	7.7	9.0
Recommended circuit breaker			A	40			20		
Wiring connections	Power supply cable (included earth, H07RN-F)		mm ² x cores	6.0 x 3 C			2.5 x 5 C		

Note

- Due to our policy of innovation, some specifications may be changed without notification.
- Wiring cable size must comply with the applicable local and national codes. Especially the power cable and circuit breaker should be selected in accordance with that.
- Sound power level is measured on the rated condition in accordance with ISO 9614 standard. Sound pressure level is converted from sound power level based on a tonality penalty of 0 dB and installation in free-field. The directivity index (Q) is assumed as 2. Therefore, these values can be increased owing to ambient conditions during operation. Rated sound power level is in accordance with EN12102-1 under condition of EN14825.
- Performances are in accordance with EN14511 and reflect ErP testing conditions. Above gives the declared values at rated conditions acc. ErP regulation
 - Rated running current: outdoor Temp. 7°C DB / 6°C WB, LWT 35°C
 - Interconnected pipe length is standard length and difference of elevation (outdoor – indoor unit) is 0 m.
- This product contains fluorinated greenhouse gases.
- All installation sites must be equipped with an earth leakage circuit breaker (ELCB).

Product specification (indoor unit)

Technical specification			Unit	HN1616M NK5	HN1636M NK5
Operation range (leaving water)	Heating	Min. – Max.	°C DB	15 – 57	
	Cooling			5 – 27 (16 – 27) ¹⁾	
	DHW			15 – 80 ²⁾	
Flow sensor	Measuring range	Min. – Max.	LPM	5 – 80	
Water pressure sensor	Measuring range	Min. – Max.	bar(G)	0 – 20	
Expansion vessel	Volume		ℓ	8	
Safety valve	Pressure limit	Upper limit	bar	3	
	Type			-	Sheath
Backup heater	Number of heating coil		EA	2	3
	Capacity combination		kW	3.0 + 3.0	2.0 + 2.0 + 2.0
	Heating steps		Step	2	2
	Power supply		V, Ø, Hz	220-240, 1, 50	380-415, 3, 50
	Rated running current		A	25.0	8.7
	Power supply cable (included earth, H07RN-F)		mm ² x cores	4.0 x 3 C	2.5 x 4 C
Piping connections	Water circuit	Inlet	inch	Male PT 1" according to ISO 7-1 (tapered pipe threads)	
		Outlet	inch	Male PT 1" according to ISO 7-1 (tapered pipe threads)	
	Refrigerant circuit	Gas (outside diameter)	mm (inch)	Ø 15.88 (5/8)	
		Liquid (outside diameter)	mm (inch)	Ø 9.52 (3/8)	
Wiring connections	Power and communication cable (included earth, H07RN-F)		mm ² x cores	0.75 x 4 C	
Sound power level	Heating	Rated	dB(A)	44	
Dimensions	Unit	W x H x D	mm	490 x 850 x 315	
Weight	Unit		kg	40.0	41.0
Exterior	Color / RAL code		-	Noble white / RAL 9016	

1) When a fan coil unit is not used.

2) DHW 50 – 80°C Operating is available only when the booster heater is operating.

Note

- Due to our policy of innovation, some specifications may be changed without notification.
- Wiring cable size must comply with the applicable local and national codes. Especially the power cable and circuit breaker should be selected in accordance with that.
- Sound power level is measured on the rated condition in accordance with ISO 9614 standard. Sound pressure level is converted from sound power level based on a tonality penalty of 0 dB and installation in free-field. The directivity index (Q) is assumed as 2. Therefore, these values can be increased owing to ambient conditions during operation. Rated sound power level is in accordance with EN12102-1 under condition of EN14825.
- Performances are in accordance with EN14511 and reflect ErP testing conditions. Above gives the declared values at rated conditions acc. ErP regulation
 - Rated running current: outdoor Temp. 7°C DB / 6°C WB, LWT 35°C
 - Interconnected pipe length is standard length and difference of elevation (outdoor – indoor unit) is 0 m.
- This product contains fluorinated greenhouse gases.
- All installation sites must be equipped with an earth leakage circuit breaker (ELCB).

Performance Table for Heating Operation

Maximum heating capacity (including defrost effect)

HU121MA U33 + HN1616M NK5 / HU123MA U33 + HN1636M NK5

Outdoor temperature	LWT 30°C	LWT 35°C	LWT 40°C	LWT 45°C	LWT 50°C	LWT 55°C
	Capacity (kW)					
-20°C DB	11.25	10.95	10.22	9.85	-	-
-15°C DB	12.00	11.32	10.90	10.32	-	-
-7°C DB	12.00	11.66	11.45	11.16	11.13	-
-4°C DB	12.00	12.00	12.00	12.00	12.00	11.24
-2°C DB	12.00	12.00	12.00	12.00	12.00	11.98
2°C DB	12.00	12.00	12.00	12.00	12.00	12.00
7°C DB	12.00	12.00	12.00	12.00	12.00	12.00
10°C DB	12.00	12.00	12.00	12.00	12.00	12.00
15°C DB	12.00	12.00	12.00	12.00	12.00	12.00
18°C DB	12.00	12.00	12.00	12.00	12.00	12.00
20°C DB	12.00	12.00	12.00	12.00	12.00	12.00
35°C DB	12.00	12.00	12.00	12.00	12.00	12.00

HU141MA U33 + HN1616M NK5 / HU143MA U33 + HN1636M NK5

Outdoor temperature	LWT 30°C	LWT 35°C	LWT 40°C	LWT 45°C	LWT 50°C	LWT 55°C
	Capacity (kW)					
-20°C DB	11.25	11.17	10.79	10.32	-	-
-15°C DB	12.11	11.98	11.54	10.90	-	-
-7°C DB	13.06	12.99	12.77	12.27	12.42	-
-4°C DB	14.00	14.00	14.00	13.64	13.09	11.67
-2°C DB	14.00	14.00	14.00	14.00	14.00	12.67
2°C DB	14.00	14.00	14.00	14.00	14.00	13.98
7°C DB	14.00	14.00	14.00	14.00	14.00	14.00
10°C DB	14.00	14.00	14.00	14.00	14.00	14.00
15°C DB	14.00	14.00	14.00	14.00	14.00	14.00
18°C DB	14.00	14.00	14.00	14.00	14.00	14.00
20°C DB	14.00	14.00	14.00	14.00	14.00	14.00
35°C DB	14.00	14.00	14.00	14.00	14.00	14.00

HU161MA U33 + HN1616M NK5 / HU163MA U33 + HN1636M NK5

Outdoor temperature	LWT 30°C	LWT 35°C	LWT 40°C	LWT 45°C	LWT 50°C	LWT 55°C
	Capacity (kW)					
-20°C DB	12.27	12.01	11.48	10.86	-	-
-15°C DB	13.11	12.90	12.62	12.30	-	-
-7°C DB	13.73	13.70	13.46	13.16	12.42	-
-4°C DB	14.36	14.50	14.30	14.01	13.40	12.50
-2°C DB	15.20	14.80	14.50	14.25	14.00	13.50
2°C DB	16.00	16.00	16.00	16.00	16.00	14.51
7°C DB	16.00	16.00	16.00	16.00	16.00	16.00
10°C DB	16.00	16.00	16.00	16.00	16.00	16.00
15°C DB	16.00	16.00	16.00	16.00	16.00	16.00
18°C DB	16.00	16.00	16.00	16.00	16.00	16.00
20°C DB	16.00	16.00	16.00	16.00	16.00	16.00
35°C DB	16.00	16.00	16.00	16.00	16.00	16.00

Note
 1. DB: Dry Bulb Temperature (°C), LWT: Leaving Water Temperature (°C)
 2. Direct interpolation is permissible. Do not extrapolate.
 3. Measuring procedure follows EN-14511.
 • Rated values are based on standard conditions and can be found on specifications.
 • Above table values may not be matched according to installation conditions. Except for rated values, the performance is not guaranteed.
 • The rating might slightly vary depending on test standards or countries.
 4. The shaded areas are not guaranteed continuous operation.

Performance Table for Cooling Operation

Maximum cooling capacity

HU121MA U33 + HN1616M NK5 / HU123MA U33 + HN1636M NK5

Outdoor temperature	LWT 7°C	LWT 10°C	LWT 13°C	LWT 15°C	LWT 18°C	LWT 20°C	LWT 22°C
	Capacity (kW)						
20°C DB	7.60	8.55	9.51	10.33	11.19	11.98	-
30°C DB	8.62	9.05	9.78	10.67	10.90	11.37	-
35°C DB	7.94	8.66	9.33	10.10	10.40	10.75	11.16
40°C DB	7.56	8.02	8.81	9.36	9.54	9.89	10.28
45°C DB	6.38	7.08	7.79	8.44	9.14	9.44	9.78

HU141MA U33 + HN1616M NK5 / HU143MA U33 + HN1636M NK5

Outdoor temperature	LWT 7°C	LWT 10°C	LWT 13°C	LWT 15°C	LWT 18°C	LWT 20°C	LWT 22°C
	Capacity (kW)						
20°C DB	8.13	9.87	10.97	11.92	12.91	13.82	-
30°C DB	9.24	10.44	11.29	12.31	12.58	13.12	-
35°C DB	8.50	9.99	10.76	11.65	12.00	12.40	12.88
40°C DB	8.10	9.25	10.17	10.80	11.01	11.42	11.86
45°C DB	7.17	8.17	8.99	9.73	10.55	10.89	11.23

HU161MA U33 + HN1616M NK5 / HU163MA U33 + HN1636M NK5

Outdoor temperature	LWT 7°C	LWT 10°C	LWT 13°C	LWT 15°C	LWT 18°C	LWT 20°C	LWT 22°C
	Capacity (kW)						
20°C DB	8.54	10.69	11.89	12.91	13.98	14.97	-
30°C DB	9.70	11.31	12.22	13.34	13.63	14.21	-
35°C DB	8.92	10.82	11.66	12.63	13.00	13.43	13.96
40°C DB	8.51	10.03	11.02	11.70	11.93	12.37	12.85
45°C DB	7.52	8.85	9.73	10.55	11.42	11.80	12.16

Note
 1. DB: Dry Bulb Temperature (°C), LWT: Leaving Water Temperature (°C)
 2. Direct interpolation is permissible. Do not extrapolate.
 3. Measuring procedure follows EN-14511.
 • Rated values are based on standard conditions and can be found on specifications.
 • Above table values may not be matched according to installation conditions. Except for rated values, the performance is not guaranteed.
 • The rating might slightly vary depending on test standards or countries.
 4. The shaded areas are not guaranteed continuous operation.

Drawings

Category	Unit	Model name		
		Capacity (kW)		
		12.0	14.0	16.0
1 Phase model 220 - 240 V, 1 Ø, 50 Hz	Outdoor unit	HU121MA U33	HU141MA U33	HU161MA U33
	Indoor unit		HN1616M NK5	
3 Phase model 380 - 415 V, 3 Ø, 50 Hz	Outdoor unit	HU123MA U33	HU143MA U33	HU163MA U33
	Indoor unit		HN1636M NK5	

HU121MA U33 / HU141MA U33 / HU161MA U33 /
HU123MA U33 / HU143MA U33 / HU163MA U33

[Unit: mm]

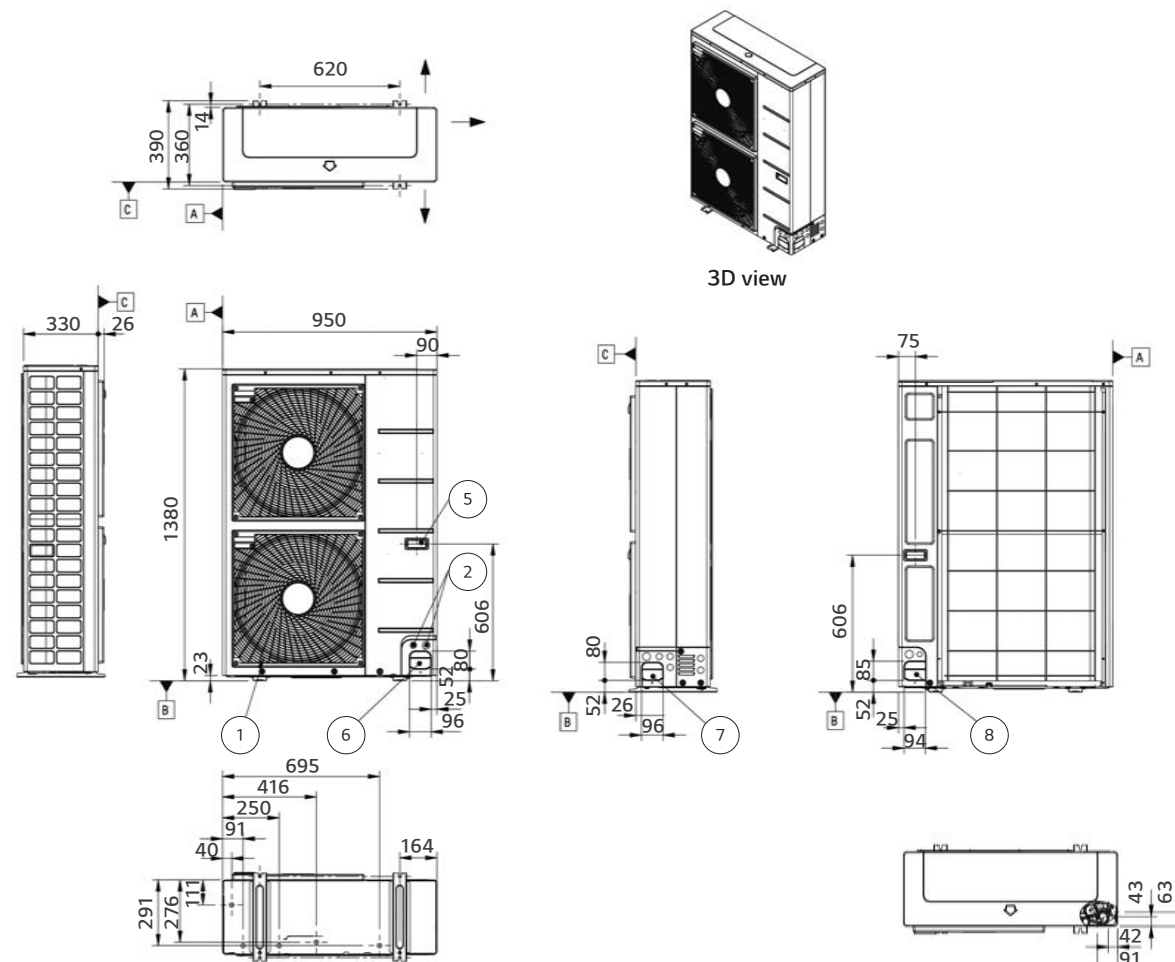

No.	Part name	Description
1	Air outlet	-
2	Power and communication cable hole	-
3	Gas pipe connection	Flare joint
4	Liquid pipe connection	Flare joint
5	Handle	-
6	Pipe routing hole (front)	-
7	Pipe routing hole (side)	-
8	Pipe routing hole (back)	-

HN1616M NK5 / HN1636M NK5

[Unit: mm]

External

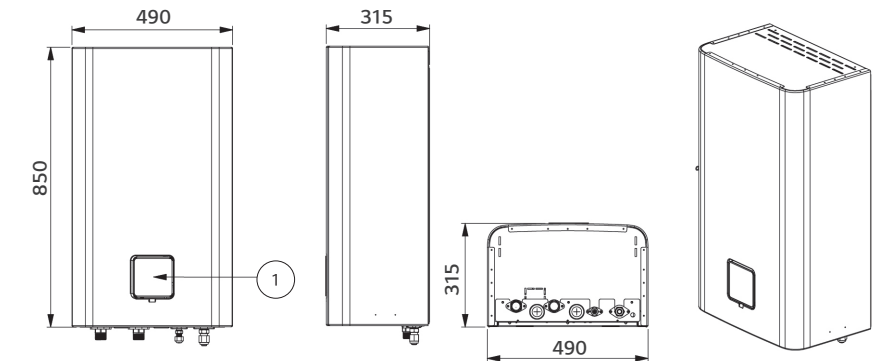

No.	Part name	Description
1	Control panel	Built-in remote controller

Internal

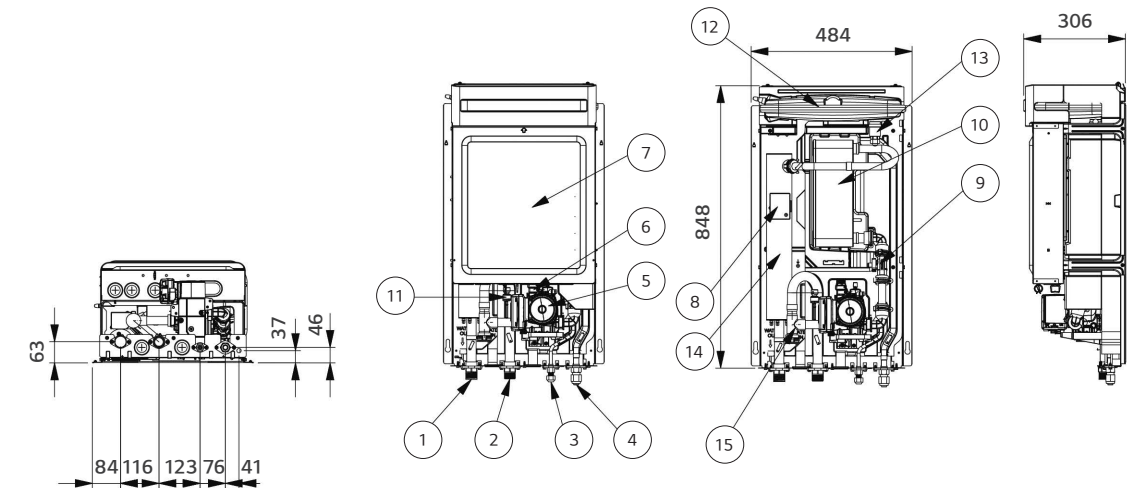

No.	Part name	Description
1	Leaving water pipe	Male PT 1" according to ISO 7-1 (tapered pipe threads)
2	Entering water pipe	Male PT 1" according to ISO 7-1 (tapered pipe threads)
3	Refrigerant pipe (liquid)	Ø 9.52 (mm)
4	Refrigerant pipe (Gas)	Ø 15.88 (mm)
5	Water pump	To circulate water inside the system
6	Safety valve	Open at water pressure 3 bar
7	Control box	PCB and terminal blocks
8	Thermal switch	Cut-off power input to electric heater at 90°C
9	Flow sensor	To measure the water flow rate (5-80 LPM)
10	Plate heat exchanger	Heat exchange between refrigerant and water
11	Pressure sensor	To measure the water pressure (0-2 MPa)
12	Expansion tank	Absorbing volume change of heated water
13	Air vent	Air purging when charging water
14	Backup heater	6 kW
15	Strainer	Filtering and stacking particles inside circulating water



THERMA V™ HIGH TEMPERATURE

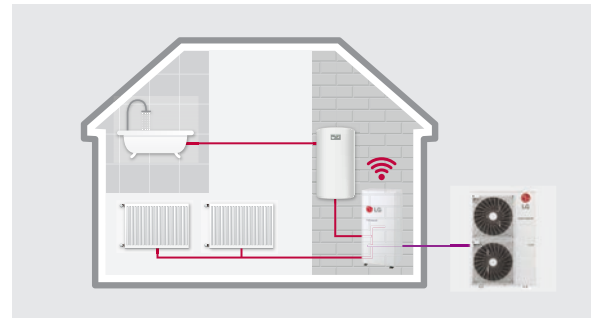
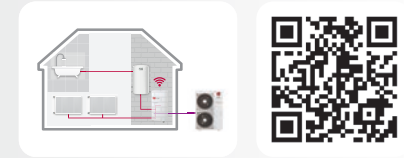

Excellent performance & efficiency

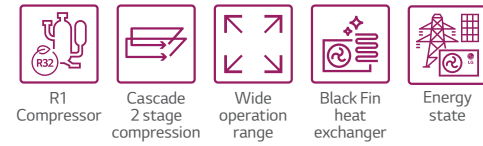

User convenience

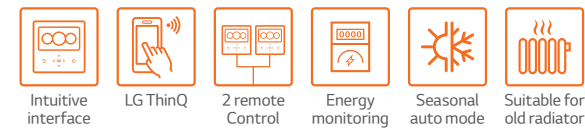

Easy installation & maintenance

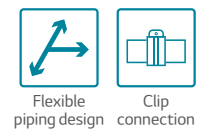

* Detailed description for each function is presented on page 44 - 54.

Energy Label

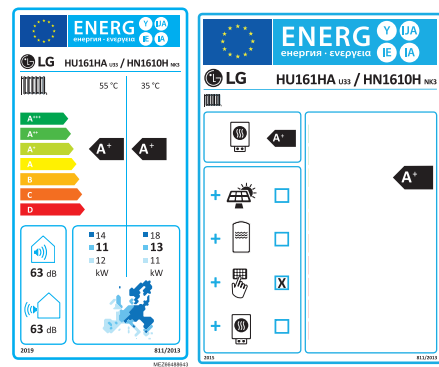

* 16 kW 1 Ø model.
* A+++ to D scale.

THERMA V High Temperature Cycle

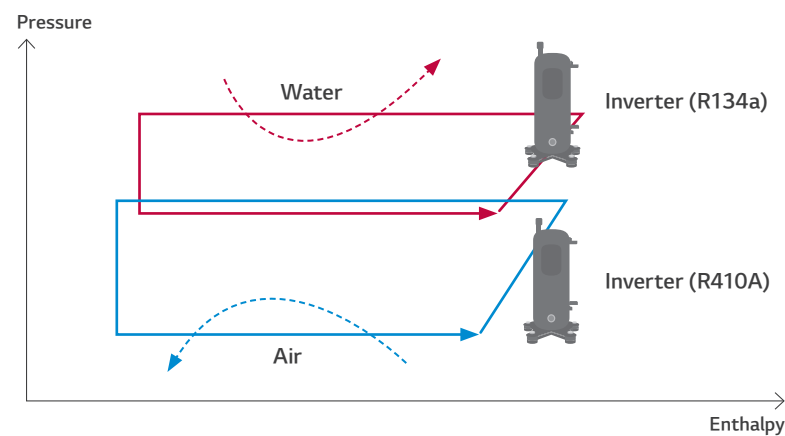

High Temperature Introduction

The LG Therma V High Temperature is a split type unit that consists of a separate indoor and outdoor unit. With cascade 2 stage compression technology, it can supply a high leaving water temperature of up to 80°C, while maintaining high energy efficiency.

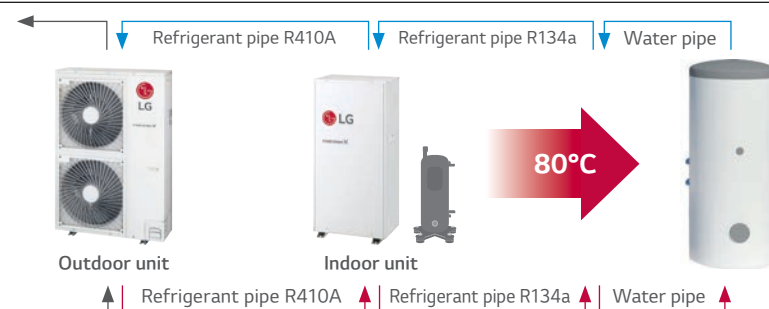

Cascade 2 Stage Compression Technology

The Therma V High Temperature unit can produce up to 80°C hot water with high efficiency through cascade 2 stage compression (from R410A to R134a) technology, making it an optimized replacement for a boiler heating system which demands hot water supply.

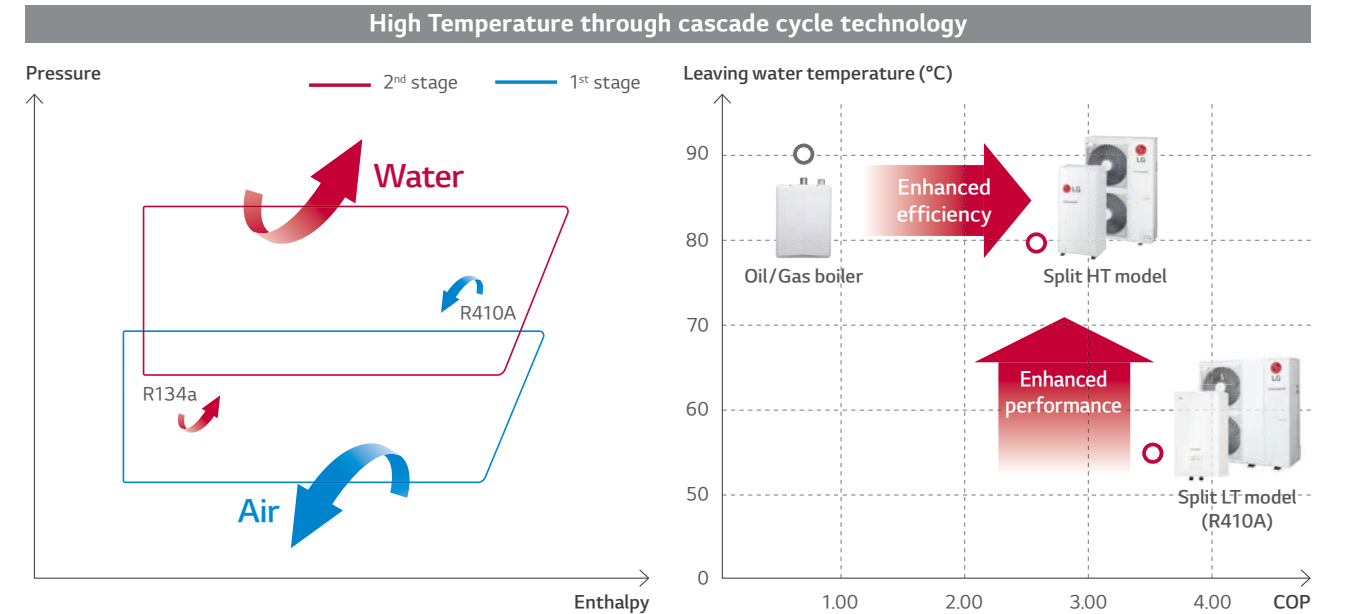

* Condition for HT model: outdoor air temp. 18°C, entering water temp. 70°C
* Condition for LT model: outdoor air temp. 18°C, entering water temp. 55°C

Note
1. OAT: Outdoor Air Temperature, EWT: Entering Water Temperature, LWT: Leaving Water Temperature

Suitable for Old Radiator

The LG Therma V High Temperature product is suitable for houses with poor insulation, an existing radiator heating system, or are required to meet sanitary water regulation needs at high temperatures.



High Temperature



Indoor unit

HN1610H NK3

Outdoor unit

HU161HA U33



RI Compressor™ Black Fin ThinQ



Features

- Maximum 80°C leaving water temperature
- Cascade 2 stage compression
- Only for heating (no cooling)
- Suitable for old radiator
- SCOP up to 3.23 (average climate / low temp. application): **A+**
- SCOP up to 3.01 (average climate / mid temp. application): **A+**
- COP up to 3.27 (outdoor air 7°C / leaving water 35°C)
- 100 % heating capacity at -7°C OAT (@ LWT 35°C)
- Wide operation range (ambient: -25 ~ 35°C / water side: 25 ~ 80°C)
- R1 Compressor (for outdoor unit)
- Black Fin heat exchanger
- LG ThinQ
- Keymark / MCS / Eurovent certification

Model line-up

Category	Unit	Model name	
		Capacity (kW)	16.0
1 Phase model 220 - 240 V, 1 Ø, 50 Hz	Outdoor unit	HU161HA U33	
	Indoor unit	HN1610H NK3	

Seasonal energy

Description	Outdoor unit		HU161HA U33	
	Indoor unit	HN1610H NK3		
Space heating (according to EN14825)	Average climate water outlet 35°C	SCOP	-	3.23
		Seasonal space heating efficiency (η_s)	%	126
	Average climate water outlet 55°C	SCOP	-	3.01
		Seasonal space heating efficiency (η_s)	%	117
		Seasonal space heating eff. class (A+++ to D scale)	-	A+

Nominal capacity and nominal power input

Description	OAT ¹⁾ (DB)	LWT ²⁾ (DB)	Outdoor unit		HU161HA U33	
			Indoor unit	HN1610H NK3		
Nominal capacity	Heating	7°C	35°C	kW	16.00	
		7°C	55°C		14.00	
		2°C	35°C		16.00	
Nominal power input	Heating	7°C	35°C	kW	4.89	
		7°C	55°C		5.00	
		2°C	35°C		4.92	
COP	Heating	7°C	35°C	W/W	3.27	
		7°C	55°C		2.78	
		2°C	35°C		3.25	

1) OAT: Outdoor Air Temperature
2) LWT: Leaving Water Temperature

Product specification (outdoor unit)

Technical specification			Unit	HU161HA U33
Operation range (outdoor temp.)	Heating	Min. - Max.	°C DB	-25 - 35
	Quantity		EA	1
Compressor	Type		-	Hermetic sealed scroll
	Type		-	R410A
Refrigerant	GWP (Global Warming Potential)		-	2,088
	Precharged amount		g	3,800
	t-CO ₂ eq		-	7,933
Piping connections	Outside diameter	Gas	mm (inch)	Ø 15.88 (5/8)
		Liquid	mm (inch)	Ø 9.52 (3/8)
	Length	Standard	m	7.5
		Max.	m	50
	Level difference	Max.	m	30
	Chargeless-pipe length		m	7.5
Additional charging volume		g/m	40	
Rated water flow rate	at LWT 35°C		LPM	46.0
Sound power level	Heating	Rated	dB(A)	63
Sound pressure level (at 1 m)	Heating	Rated	dB(A)	55
Dimensions	Unit	W x H x D	mm	950 x 1,380 x 330
Weight	Unit		kg	89.0
Exterior	Color / RAL code		-	Warm gray / RAL 7044
	Voltage, phase, frequency		V, Ø, Hz	220-240, 1, 50
Power supply	Rated running current	Heating	A	8.4
	Recommended circuit breaker		A	20
Wiring connections	Power cable (included earth)		mm ² x cores	4.0 x 3 C

Product specification (indoor unit)

Technical specification			Unit	HN1610H NK3
Operation range (leaving water temp.)	Heating	Min. - Max.	°C DB	25 - 80
	Quantity		EA	1
Compressor	Type		-	Hermetic sealed twin rotary
	Type		-	R134a
Refrigerant	GWP (Global Warming Potential)		-	1,430
	Precharged amount		g	1,800
	t-CO ₂ eq		-	2,574
Piping connections	Water circuit	Inlet	inch	Male PT 1" according to ISO 7-1 (tapered pipe threads)
		Outlet	inch	Male PT 1" according to ISO 7-1 (tapered pipe threads)
	Refrigerant circuit	Gas (outside diameter)	mm (inch)	Ø 15.88 (5/8)
		Liquid (outside diameter)	mm (inch)	Ø 9.52 (3/8)
Rated water flow rate (at LWT 35°C)			LPM	46.0
Sound power level	Heating	Rated	dB(A)	58 / 63 ¹⁾
Sound pressure level (at 1 m)	Heating	Rated	dB(A)	50
Dimensions	Unit	W x H x D	mm	520 x 1,080 x 330
Weight	Unit		kg	84.0
Exterior	Color / RAL code		-	Morning gray / RAL 7030
	Voltage, phase, frequency		V, Ø, Hz	220 - 240, 1, 50
Power supply	Rated running current	Heating	A	9.8
	Recommended circuit breaker		A	25
Wiring connections	Power cable (included earth)		mm ² x cores	4.0 x 3 C (H07RN-F)
	Communication cable (included earth)		mm ² x cores	1.0 - 1.5 x 2 C (VCTF-SB)
Accessory kit of the indoor unit			Unit	HN1610H NK3
Remote controller			-	Standard III
Water tank temperature sensor with holder	Sensor size		Ø	7
	Resistance		kΩ	5
Strainer	Mesh size / material		-	28 mesh / stainless steel

1) This sound power level (63 dB(A)) is when AC cooling fan is operated.

Note

- Due to our policy of innovation, some specifications may be changed without notification.
- Wiring cable size must comply with the applicable local and national codes. Especially the power cable and circuit breaker should be selected in accordance with that.
- Sound power level is measured on the rated condition in accordance with ISO 9614 standard. Sound pressure level is converted from sound power level based on a tonality penalty of 0 dB and installation in free-field. The directivity index (Q) is assumed as 2. Therefore, these values can be increased owing to ambient conditions during operation. Rated sound power level is in accordance with EN12102-1 under condition of EN14825.
- Performances are in accordance with EN14511 and reflect ErP testing conditions. Above gives the declared values at rated conditions acc. ErP regulation.
 - Rated running current: outdoor Temp. 7°C DB / 6°C WB, LWT 35°C
 - Interconnected pipe length is standard length and difference of elevation (outdoor - indoor unit) is 0 m.
- This product contains fluorinated greenhouse gases.
- All installation sites must be equipped with an earth leakage circuit breaker (ELCB).

Performance Table for Heating Operation

Maximum heating capacity (including defrost effect)

HU161HA U33 + HN1610H NK3

Outdoor temperature	LWT 35°C	LWT 40°C	LWT 45°C	LWT 50°C	Capacity (kW)						
	LWT 55°C	LWT 60°C	LWT 65°C	LWT 70°C	LWT 75°C	LWT 80°C					
-25°C DB	13.50	13.29	13.07	12.86	12.64	12.43	12.21	12.00	-	-	-
-20°C DB	14.19	14.04	13.88	13.73	13.58	13.42	13.27	13.11	12.96	-	-
-15°C DB	14.89	14.79	14.70	14.60	14.51	14.41	14.32	14.22	14.10	14.00	14.00
-7°C DB	16.00	16.00	16.00	16.00	16.00	16.00	16.00	16.00	16.00	16.00	16.00
-4°C DB	16.00	16.00	16.00	16.00	16.00	16.00	16.00	16.00	16.00	16.00	16.00
-2°C DB	16.00	16.00	16.00	16.00	16.00	16.00	16.00	16.00	16.00	16.00	16.00
2°C DB	16.00	16.00	16.00	16.00	16.00	16.00	16.00	16.00	16.00	16.00	16.00
7°C DB	16.00	16.00	16.00	16.00	16.00	16.00	16.00	16.00	16.00	16.00	16.00
10°C DB	16.00	16.00	16.00	16.00	16.00	16.00	16.00	16.00	16.00	16.00	16.00
15°C DB	16.00	16.00	16.00	16.00	16.00	16.00	16.00	16.00	16.00	16.00	16.00
18°C DB	16.00	16.00	16.00	16.00	16.00	16.00	16.00	16.00	16.00	16.00	16.00
20°C DB	16.00	16.00	16.00	16.00	16.00	16.00	16.00	16.00	16.00	16.00	16.00
35°C DB	16.00	16.00	16.00	16.00	16.00	16.00	16.00	16.00	16.00	16.00	16.00

Note

1. DB: Dry Bulb Temperature (°C), LWT: Leaving Water Temperature (°C)
2. Direct interpolation is permissible. Do not extrapolate.
3. Measuring procedure follows EN-14511.
 - Rated values are based on standard conditions and can be found on specifications.
 - Above table values may not be matched according to installation conditions. Except for rated values, the performance is not guaranteed.
 - The rating might slightly vary depending on test standards or countries.
4. The shaded areas are not guaranteed continuous operation.

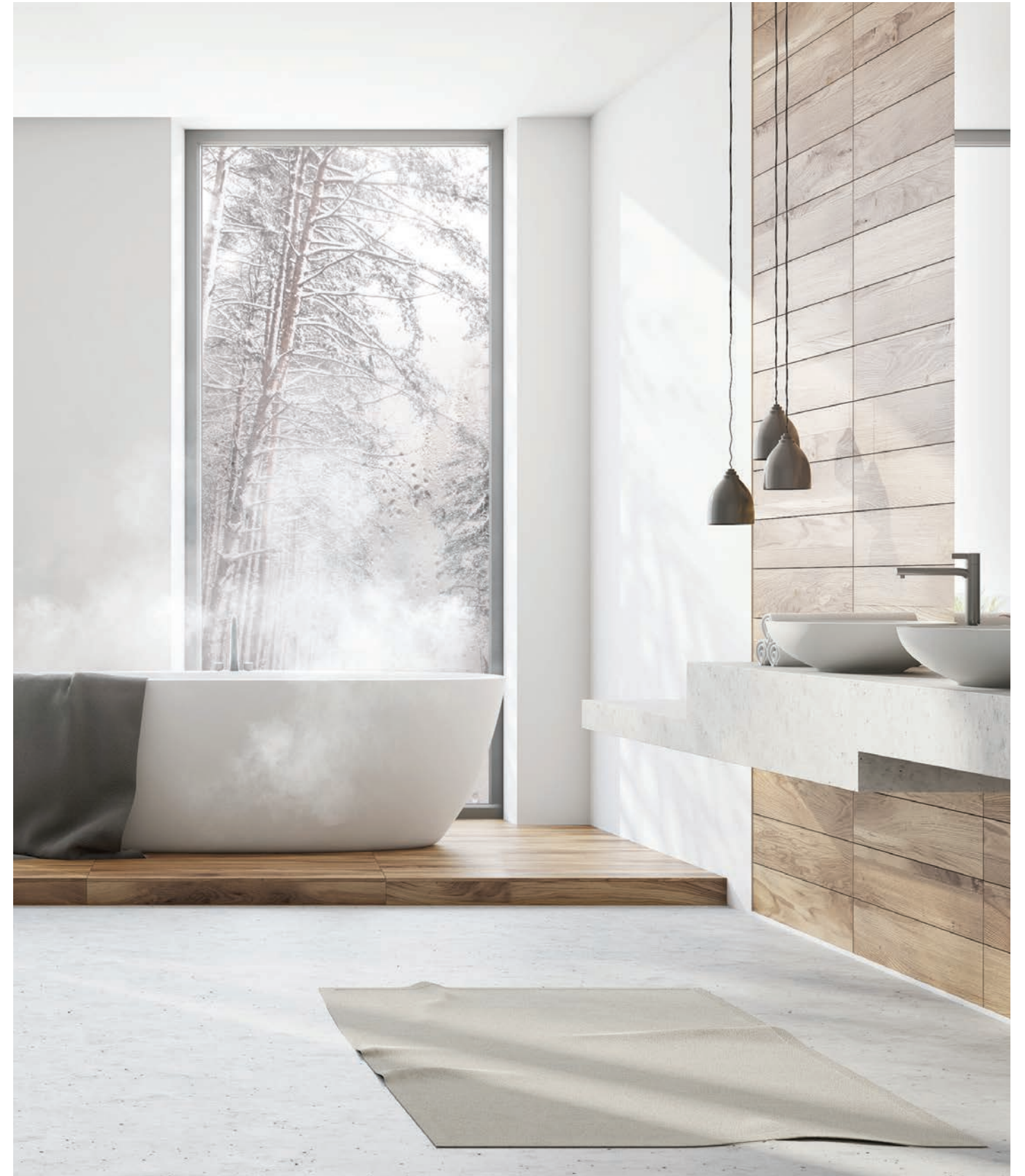

Drawings

Category	Unit	Model name
		Capacity (kW)
1 Phase model 220 - 240 V, 1 Ø, 50 Hz	Outdoor unit	HU161HA U33
	Indoor unit	HN1610H NK3

HU161HA U33

[Unit: mm]

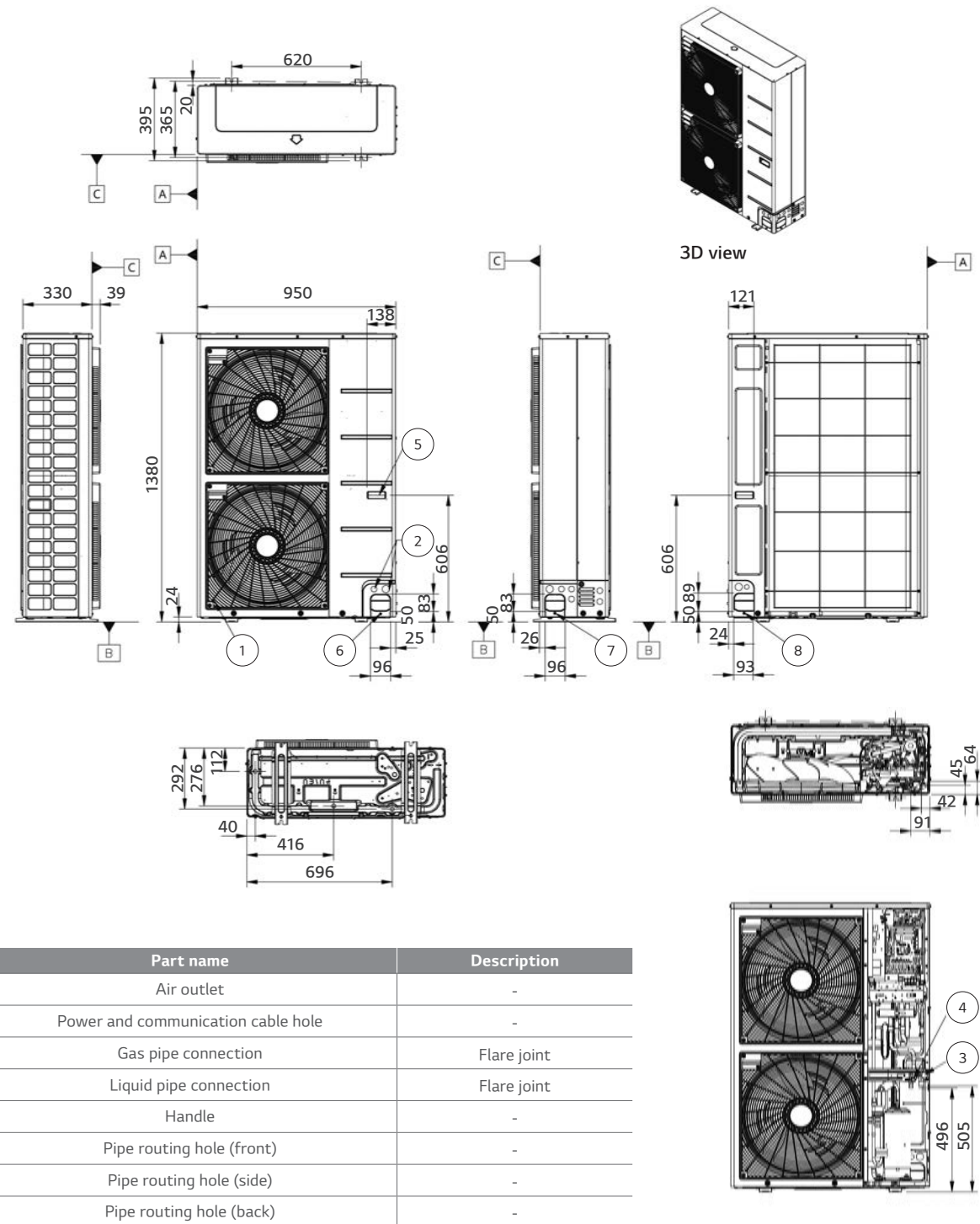

HN1610H NK3

[Unit: mm]

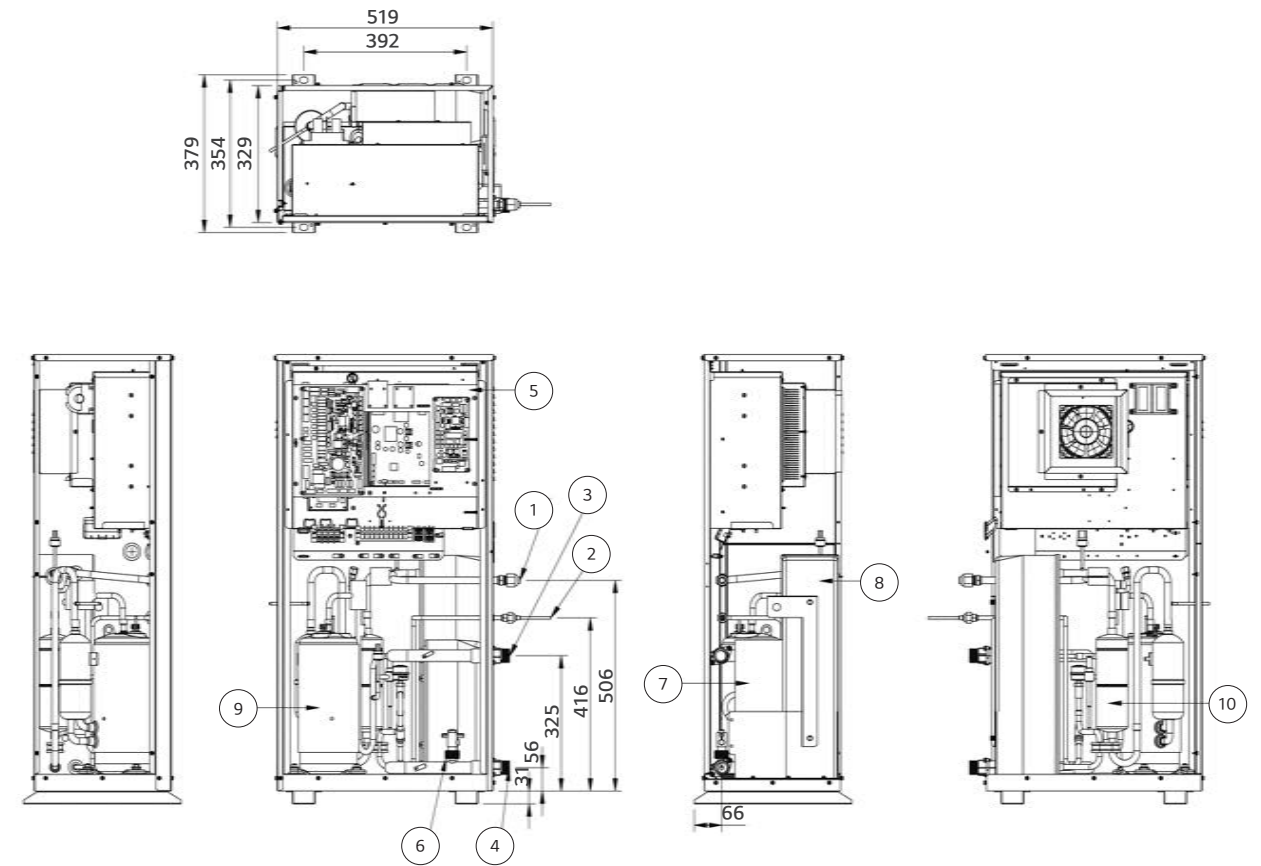



THEIRMA V™ HEAT PUMP WATER HEATER

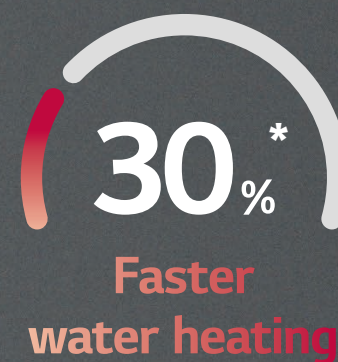
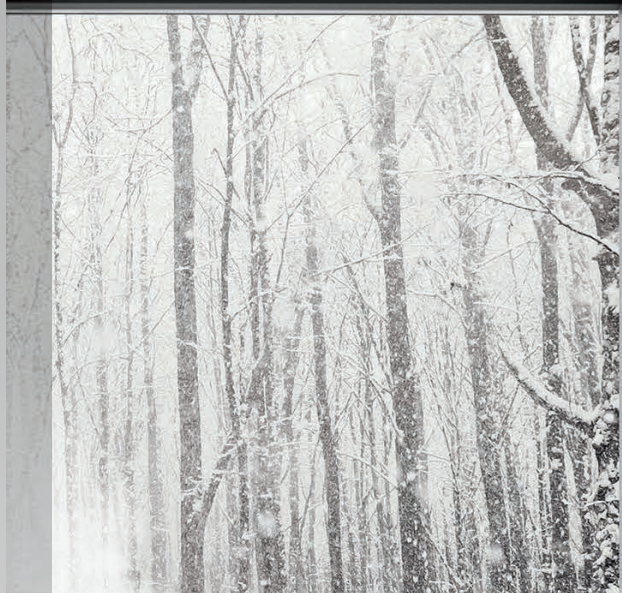
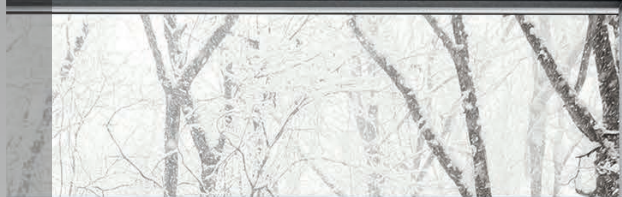

* This figure is the result of LG internal test compared to the electric heater, so it may differ from actual operation.



THERMA V™ HEAT PUMP WATER HEATER

PRODUCT FEATURES

Stylish Design

LG unit's exclusive square shape and luxury silver color make it an excellent fit for any interior design.



Perfect matching with various spaces



Top Class Energy Efficiency

LG's new Inverter Heat Pump Water Heater with the highly efficient DUAL Inverter Compressor allows for impressive energy savings of over 70 % compared to a conventional electric heater.



Energy saving

Benefiting from the market's first DUAL Inverter Compressor, LG's Heat Pump Water Heater can run at low rotational speed (up to 10 Hz), reducing energy consumption by 70 % more than an electric water heater (250 ℓ, C class).

Average estimated energy consumption savings per year

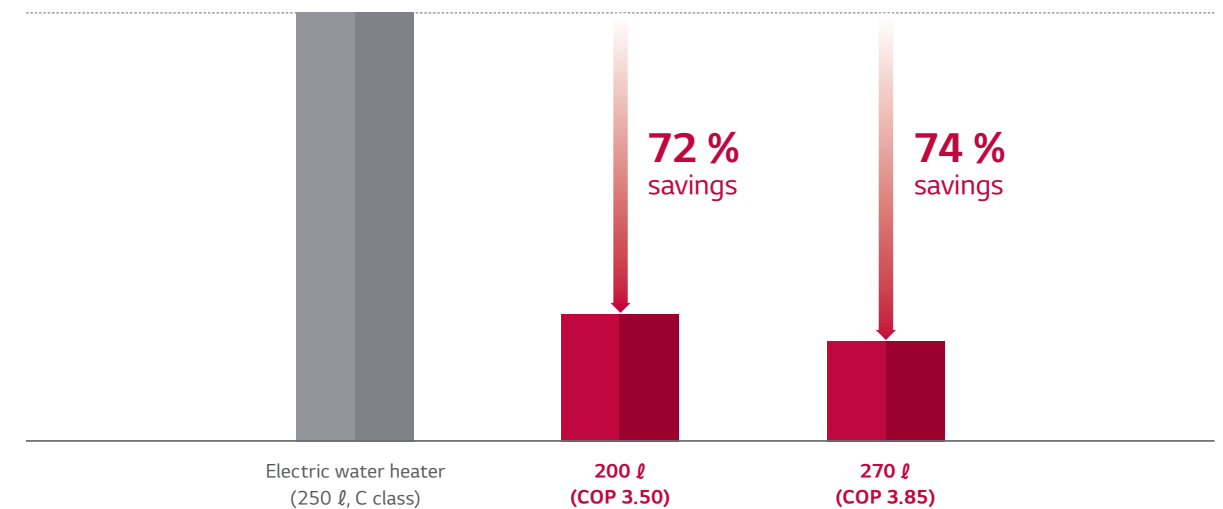

※ Simulation data on daily electricity consumption, based on EU climate conditions (average, 15°C).
 ※ The data are based on LG internal simulation.
 ※ The data are depending on the experimental conditions and is changeable according to the usage environment

Powerful Heating Performance

The DUAL Inverter Compressor maximizes the heat pump's power in turbo mode for a 30 % faster heating time for first-use water than in auto operation mode.



Fast & powerful water heating

Turbo mode can run at high speeds (up to 80 Hz) with simultaneous heating. The target water temperature in the tank will be achieved 30 % faster in turbo mode than in in use auto mode or auto mode in one hour of operation starting from an empty tank. Furthermore, turbo mode can recover the water at 25 % warmer temperatures than in use auto mode or auto mode in one hour of operation starting from an empty tank.

※ The data are based on LG internal tests and simulations.
 ※ The data depend on the experimental conditions and are changeable according to the usage environment.

Continuous operation

The two heat sources, two heaters and a heat pump complement each other perfectly. If the heat pump or one of the heaters fails, the other heat source allows alternative operation.

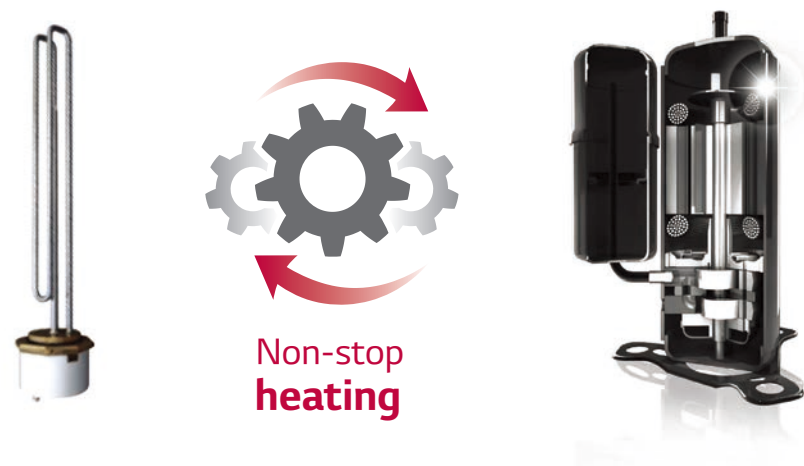

Low Noise Operation

Through BLDC motor and DUAL Inverter Compressor, noise is reduced to 53 dB(A) (sound power) and provides a comfortable environment even in indoor installation scenes.

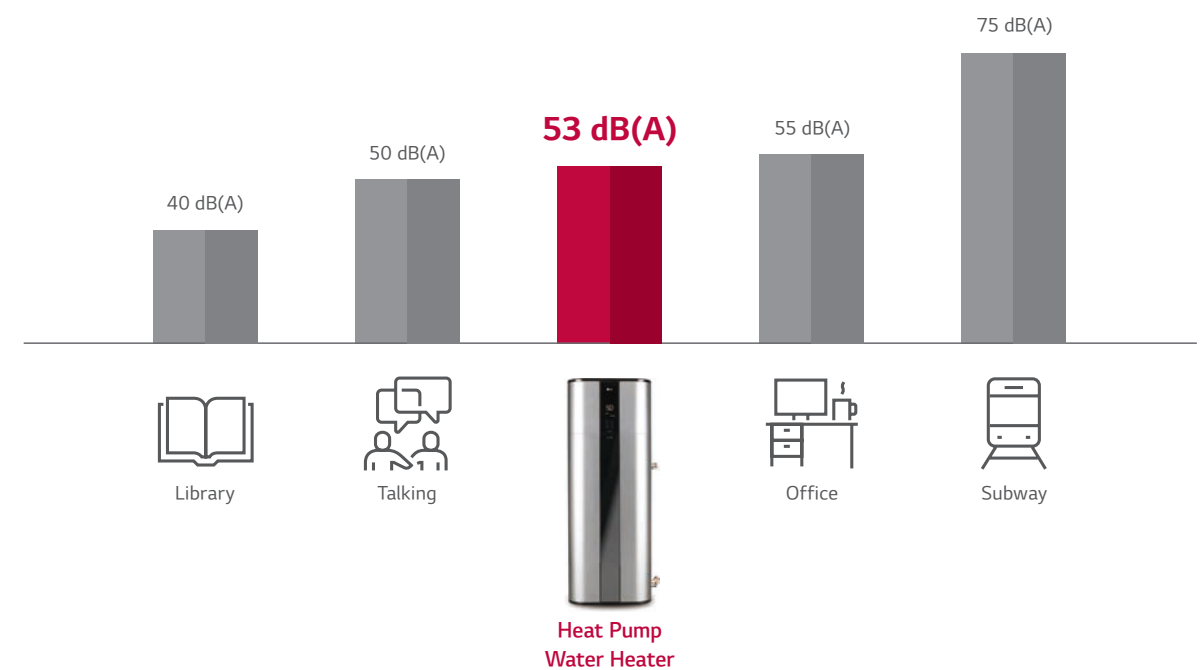

※ Sound pressure is 38 dB(A) based on LG internal test.
 ※ The data are based on LG internal test (sound power).
 ※ The data are based on LG internal tests and simulations.
 ※ The data are depending on the experimental conditions and is changeable according to the usage environment.

Various Operation Mode

LG Inverter Heat Pump Water Heater can be operated in four different modes for different conditions.

Heat pump
Heating water with the heat pump function

Turbo
Boosting the heat function to quickly heat water

Auto
Automatically controls the heat pump and heating functions for optimal performance

Vacation
Minimizing the energy loss while the heat function is not in use

Operation



Using basic control

Display screen

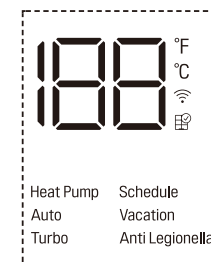

Display screen

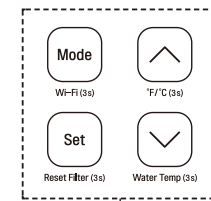

Button

Button	Display screen	Description
Mode	Heat pump	To select the heat pump mode
	Auto	To select the auto mode
	Turbo	To select the turbo mode
	Vacation	To select the vacation mode
-	Schedule	Set schedule mode only in LG ThinQ application
-	Anti legionella	To select the anti legionella mode
Set	-	To set the desired water temperature
↑ ↓	188	To adjust the desired water temperature
Wi-Fi (3s)	Wi-Fi icon	To enable the Wi-Fi pairing
Reset Filter (3s)	Filter icon	To reset the filter alarm
°F/°C (3s)	°F / °C	To change unit between °F and °C
Water Temp (3s)	188	To display the current water temperature for 5 seconds

Smart Control

With the LG ThinQ smartphone app, users can easily control and monitor the heat pump, checking for current water temperatures, setting operating schedules and more.



Embedded Wi-Fi

You can control the LG ThinQ app, checking information such as current water temperature, operating mode and more.



Smart diagnosis

Smart diagnosis allows users to conveniently check setup, installation, troubleshooting and other information directly from a smartphone.



Easy check & monitoring

Easily comprehensible error messages make detecting a solution and contacting the service center simple and convenient.



THERMA V™ HEAT PUMP WATER HEATER

powered by
DUAL Inverter Compressor™

LG's DUAL Inverter Compressor™ - exceptional in the market - saves energy with a wide power-saving operating range and produces efficient heating, performing quietly even in max operation mode. This technology allows the inverter compressor to achieve superior energy efficiency, cooling performance and comfort compared to compressors with on-off capabilities which is rare for monobloc heat pump water heaters.



Varied-speed dual rotary

A compressor motor has a wider energy efficient rotational frequency and a higher volumetric quick cooling capacity compared to a conventional non-inverter compressor.

Product reliability improvement

As twin rotaries balance each other while they are rotating with high speed, it reduces noise dramatically compared to a shaking single rotary compressor. The reduction in vibration reduces the possibility of fractures occurring in the surrounding pipework.

※ The data are based on LG internal test and simulation.
※ The data depend on the experimental conditions and are changeable according to the usage environment

Benefit & verification

Reliable air conditioner

The product safety is guaranteed with a 10-year warranty offered to customers.



Verification

TUV Rheinland, long term accelerated-reliability test & high marginal test



Twin rotary type

※ Long term accelerated-reliability test
LG's unique testing method with reinforced operating condition for a product life assurance to test and determine the product life cycle in a short period of time by accelerating the life cycle.
※ High marginal test
Test method to secure durability in various adverse conditions that may occur in the field by performing compressor reliability test against higher pressure and temperature than the designed range of pressure and temperature which the compressor operates in.
※ Verification obtained from TUV Rheinland for 10-year product life cycle.

PRODUCT FEATURES

Quick & Easy Installation

The machine's one-direction inlet and outlet piping and easy-to-connect wires in the junction box allow for quick and easy installation. Furthermore, the LG ThinQ app provides service alarm and self diagnosis programs for convenient maintenance.



10-year warranty

The core parts of heat pump water heaters such as water tank and compressor are certified for 10-year durability by TUV Rheinland. ceramic coating inside the water tank meets Germany ceramic standard DIN 4753 and guarantees 10 years of corrosion resistance.



※ Other parts warranty may vary according to after sales service condition

THERMA V™ HEAT PUMP WATER HEATER



011-1W0461

Product specification

Sales model			WH20S
Factory model			R5TT20F-SA1
Capacity	Volume (nominal)	ℓ	200
Energy efficiency ¹⁾	COP (7°C / 15°C)		3.30 / 3.50
Energy consumption	Annual energy consumption (7°C / 15°C)	kWh	756 / 709
Load profile			Large
Power input	Upper element wattage (230 V)	kW	2
	Lower element wattage (230 V)	kW	2
Energy efficiency class (7°C / 15°C)			A+ / A+
Power supply	V, Ø, Hz		230 / 1 / 50
Available voltage range	V		195 - 265
Operating mode			Turbo / Auto / Heat pump / Vacation / Anti legionella
Air flow rate	H / M	m ³ /min	6.7 / 4.4
	H / M	CFM	236.6 / 155.4
Sound pressure level	Auto	dB(A)+3	38
Sound power level		dB(A)	55
Dimensions	Net (W x H x D)	mm	580 x 1,625 x 582
Weight	Net	kg	100
Nominal insulation thickness	Min. / Max.	mm	40 / 80
Heat pump operation range	Min. / Max.	°C DB	-5 / 48
Exterior color code			Luxury silver
Compressor	Type		Inverter twin rotary
	Warranty	Year	10
	Manufacturer		LG Electronics
	Motor output	W	510
Design pressure (system)	High side		2.0 MPa / 290 PSI
	Low side		0.9 MPa / 130.5 PSI
Max. working pressure (water tank)			150 PSI (1,034 kPa)
Circuit breaker		A	15
Condensate water connection	I.D	mm	19, 12.7
V40 (Mixed water at 40°C)		ℓ	260
Refrigerant	Type		R134a
	Pre charge	kg	0.650
	GWP		1,430
	t-CO ₂ eq		0.930
Defrost method			Reverse cycle
Anode			Impressed current cathodic protection
T&P relief valve			Yes
Water connection location			side
Water connection size	inch		G ¾ M
Digital display			Yes
Wi-Fi (LG ThinQ) ²⁾			Yes
Tank warranty	Year		10

1) Water heater energy efficiency (at auto mode)

2) ThinQ main function

- Operation mode (auto, heatpump, turbo, vacation, schedule), temperature setting
- Monitoring hot water temperature
- Maintenance point alarm (filter, anode rod, etc.)

※ This product contains fluorinated greenhouse gases (R134a).

※ GWP: Global Warming Potential

※ t-CO₂eq: F-gas (kg)*GWP/1000

※ Specification, design and feature are subject to change without prior notice.

PRODUCT SPECIFICATION



011-1W0462

Product specification

Sales model			WH27S
Factory model			R5TT27F-SA0
Capacity	Volume (nominal)	ℓ	270
Energy efficiency ¹⁾	COP (7°C / 15°C)		3.45 / 3.85
Energy consumption	Annual energy consumption (7°C / 15°C)	kWh	712 / 646
Load profile			Large
Power input	Upper element wattage (230 V)	kW	2
	Lower element wattage (230 V)	kW	2
Energy efficiency class (7°C / 15°C)			A+ / A++ ²⁾
Power supply	V, Ø, Hz		230 / 1 / 50
Available voltage range	V		195 - 265
Operating mode			Turbo / Auto / Heat pump / Vacation / Anti legionella
Air flow rate	H / M	m ³ /min	6.7 / 4.4
	H / M	CFM	236.6 / 155.4
Sound pressure level	Auto	dB(A)+3	38
Sound power level		dB(A)	55
Dimensions	Net (W x H x D)	mm	580 x 2,008 x 582
Weight	Net	kg	119
Nominal insulation thickness	Min. / Max.	mm	40 / 80
Heat pump operation range	Min. / Max.	°C DB	-5 / 48
Exterior color code			Luxury silver
Compressor	Type		Inverter twin rotary
	Warranty	Year	10
	Manufacturer		LG Electronics
	Motor output	W	510
Design pressure (system)	High side		2.0 MPa / 290 PSI
	Low side		0.9 MPa / 130.5 PSI
Max. working pressure (water tank)			150 PSI (1,034 kPa)
Circuit breaker		A	15
Condensate water connection	I.D	mm	19, 12.7
V40 (Mixed water at 40°C)		ℓ	360
Refrigerant	Type		R134a
	Pre charge	kg	0.750
	GWP		1,430
	t-CO ₂ eq		1.073
Defrost method			Reverse cycle
Anode			Impressed current cathodic protection
T&P relief valve			Yes
Water connection location			side
Water connection size	inch		G ¾ M
Digital display			Yes
Wi-Fi (LG ThinQ) ²⁾			Yes
Tank warranty	Year		10

1) Water heater energy efficiency (at auto mode)

2) Energy label marked A+ and more than COP 3.75 in EU standard is A++

3) ThinQ main function

- Operation mode (auto, heatpump, turbo, vacation, schedule), temperature setting
- Monitoring hot water temperature
- Maintenance point alarm (filter, anode rod, etc.)

※ This product contains fluorinated greenhouse gases (R134a).

※ GWP: Global Warming Potential

※ t-CO₂eq: F-gas (kg)*GWP/1000

※ Specification, design and feature are subject to change without prior notice.

Drawings

Category	Model name	
	Capacity (DWH tank volume)	
	200 ℓ	270 ℓ
1 Phase model 230 V, 1 Ø, 50 Hz	WH20S	WH27S

WH20S

[Unit: mm]

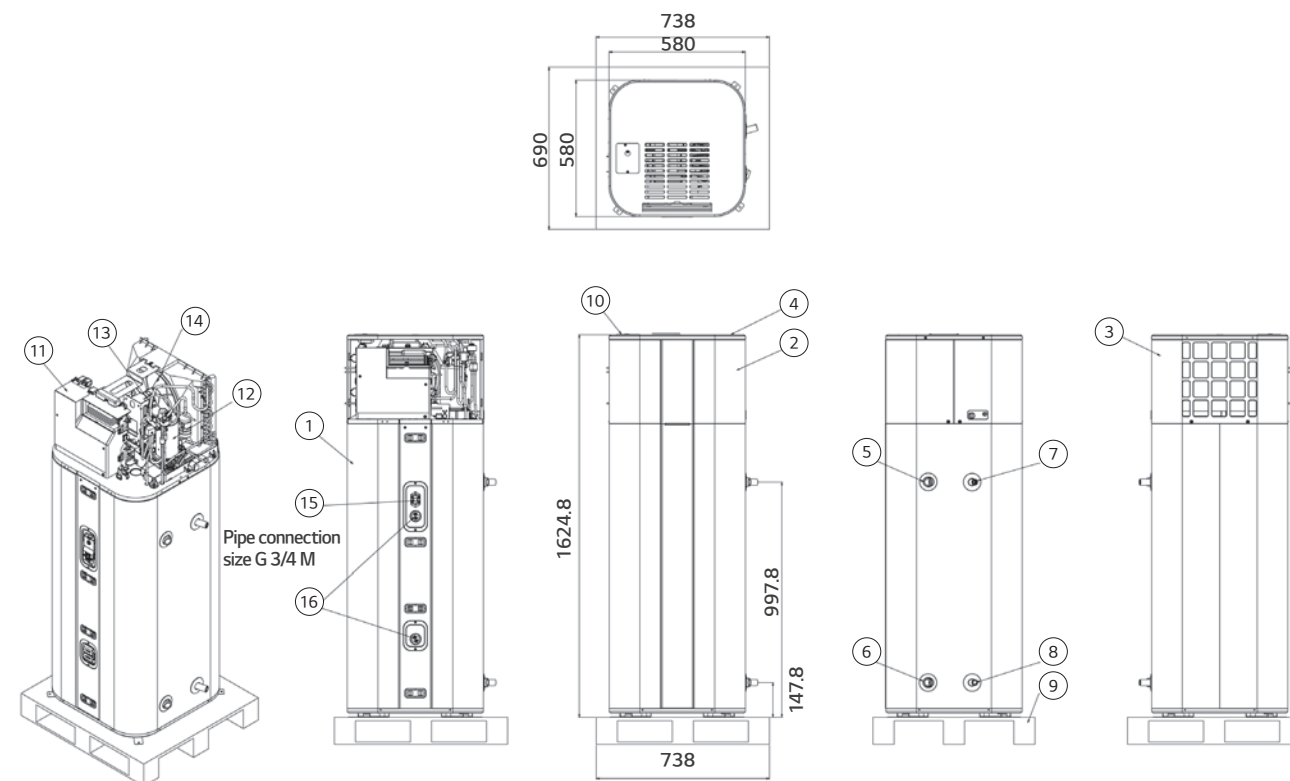

No.	Part name	Description
1	Water tank	200 ℓ
2	Front panel	-
3	Rear panel	-
4	Top cover	-
5	T/P valve	210 °F / 99 °C 3/4 NPT
6	Drain valve	3/4 NPT
7	Outlet pipe	Water out, 3/4 NPT
8	Inlet pipe	Water in, 3/4 NPT

No.	Part name	Description
9	Wooden pallet	-
10	Junction cover	Power input
11	C/B case	-
12	Compressor	EST092MBA
13	Motor	43 W
14	Fan propeller	290 Ø
15	ECO	Emergency cut off (77°C)
16	Heater	2 EA, 2000 W+2000 W, 220 ~ 240 V

WH27S

[Unit: mm]

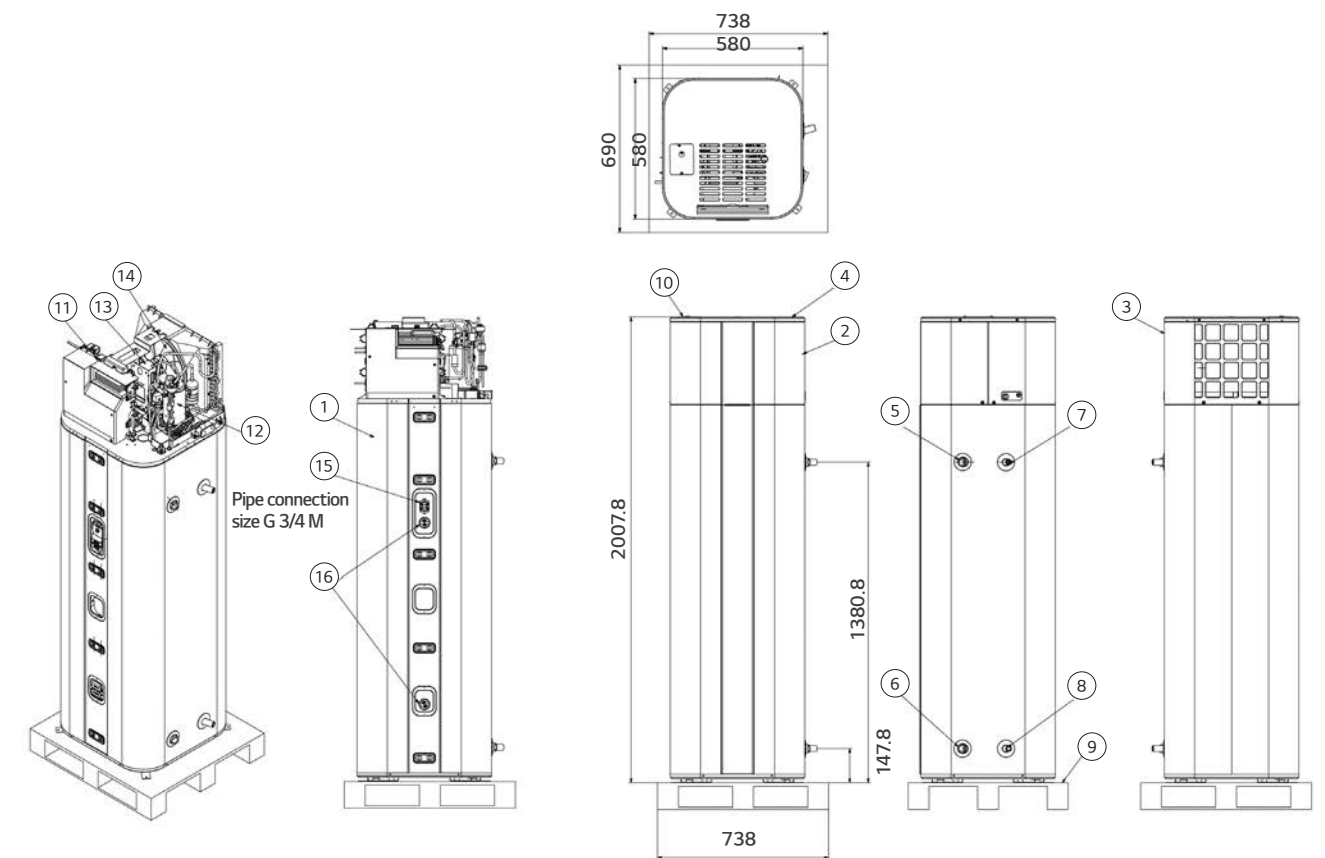

No.	Part name	Description
1	Water tank	270 ℓ
2	Front panel	-
3	Rear panel	-
4	Top cover	-
5	T/P valve	210 °F / 99 °C 3/4 NPT
6	Drain valve	3/4 NPT
7	Outlet pipe	Water out, 3/4 NPT
8	Inlet pipe	Water in, 3/4 NPT











No.	Part name	Description
9	Wooden pallet	-
10	Junction cover	Power input
11	C/B case	-
12	Compressor	EST092MBA
13	Motor	43 W
14	Fan propeller	290 Ø
15	ECO	Emergency cut off (77°C)
16	Heater	2 EA, 2000 W+2000 W, 220 ~ 240 V

THEIRMA V™ ACCESSORIES





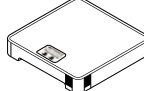

Accessories Provided by LG







Category	Model name	Model number	Figure	Applicable product	Relevant function	Purpose	Feature
Sensors	Room temperature sensor	PQRSTA0		All Therma V products	Room temperature based control	To detect room air temperature for room temperature based control	• Max. wire length: 15 m
	Thermistor for 2 nd circuit or e/heater	PRSTAT5K10		All except for High Temperature	2 nd circuit (mixing circuit)	To detect 2 nd circuit temperature when using 2 nd circuit function	• 5 kΩ thermistor, 10 m
	Domestic hot water sensor	PHRSTA0		All except for R32 Split IWT and R32 Hydrosplit IWT	Domestic hot water heating	To detect DHW tank temperature	• Included in DHW tank kit
Valves	3 way valve	OSHA-3 V		All except for R32 Split IWT and R32 Hydrosplit IWT	Domestic hot water heating	To divert water flow between space heating and DHW heating	• Size: DN 20 G 1" connection, male threaded
	Thermostatic mixing valve	OSHA-MV OSHA-MV1		Regardless of the model	Domestic hot water supply	To blend hot water with cold water for ensuring constant, safe shower and bath outlet temp.	• Size: 3/4" DN20 male threaded • Size: 1" DN25 male threaded
DHW tanks	Domestic hot water tank (single coil)	OSHW-200 F OSHW-300 F OSHW-500 F		All except for R32 Split IWT and R32 Hydrosplit IWT	Domestic hot water heating	To generate and store domestic hot water	• Storage volume: 200 ℓ, 300 ℓ, 500 ℓ • Type: internal single coil • Material: stainless steel • Capacity of booster heater: 2.4 kW
	Domestic hot water tank (double coil)	OSHW-300 FD		All except for R32 Split IWT, R32 Hydrosplit IWT and High Temperature			• Storage volume: 300 ℓ • Type: internal double coil • Material: stainless steel • Capacity of booster heater: 2.4 kW
Installation kits	Domestic hot water tank kit	PHLTA		Hydro Box for Split & Hydrosplit	Domestic hot water heating	To operate with DHW tank including the booster heater	• Parts included: DHW tank sensor (thermistor), circuit breaker, relay
		PHLTC		Old Hydro Box for R410A Split - 3 Ø (HN1639 NK3 only)			
		PHLTB	R32 Monobloc, R32 Monobloc S				
	Solar thermal kit	PHLLA		R32 Split 4/6 kW Hydro Box (HN0613M NK5), R32 Monobloc, R410A Split Hydro Box (HN1616 NK3 / HN1639 NK3)	Solar thermal heat utilization	To operate with solar thermal system	• Length of thermistor: 12 m • Size of tube connector (W x H x D): 110 x 55 x 22

Category	Model name	Model number	Figure	Applicable product	Relevant function	Purpose	Feature
Installation kits	Electric back-up heater	HA031M E1		R32 Monobloc, R32 Monobloc S	Capacity back up & emergency operation	To supplement insufficient capacity	• Heater capacity: 3 kW • Number of heating coil: 1ea (3.0 kW) • Size (W x H x D): 210 x 607 x 217 • Power: 220 - 240 V, 1 Ø
		HA061M E1					• Heater capacity: 6 kW • Number of heating coil: 2 ea (3.0 + 3.0 kW) • Size (W x H x D): 210 x 607 x 217 • Power: 220 - 240 V, 1 Ø
		HA063M E1					• Heater capacity: 6 kW • Number of heating coil: 3 ea (2.0 + 2.0 + 2.0 kW) • Size (W x H x D): 210 x 607 x 217 • Power: 380 - 415 V, 3 Ø
	R32 Hydrosplit Hydro Box (HN1600MC NK1)	HA061C E1		Capacity back Up & emergency operation	To supplement insufficient capacity	• Heater capacity: 6 kW • Number of heating coil: 2 ea (3.0 + 3.0 kW) • Power: 220-240 V, 1 Ø	
HA063C E1			Capacity back Up & emergency operation	To supplement insufficient capacity	• Heater capacity: 6 kW • Number of heating coil: 3 ea (2.0 + 2.0 + 2.0 kW) • Power: 380-415 V, 3 Ø		
Vessel	Buffer tank for space heating	OSHB-40KT		R32 Hydrosplit IWT	-	To provide the buffer volume of water to the heating circuit	• Volume: 40 ℓ • Size (W x H x D): 518 x 560 x 175
	Expansion vessel for DHW	OSHE-12KT		R32 Hydrosplit IWT	-	To absorb the volume changes by temperature of water for the DHW circuit	• Volume: 8 ℓ • Connection: 3/4" • Max. pressure: 10 bar • Size (W x H x D): 416 x 238 x 502
ETC	Extension wire for a wired remote controller	PZCWRC1		All Therma V products	-	To extend the wire between the wired remote controller and the indoor unit	• Length: 10 m
	Extension cable for Wi-Fi modem	PWYREW000		All Therma V products	Wi-Fi control via LG ThinQ	To extend a wire between the Wi-Fi modem and the indoor unit	• Length: 10 m
	2-remote control wire	PZCWRC2		All Therma V products	2 remote control	To connect two remote controllers on one indoor unit	• Length: 0.25 m
	Drain pan	PHDPB		R32 Split Hydro Box (NK4 suffix), R410A Split Hydro Box (NK3 suffix)	Cooling operation	To collect condensed water in the indoor unit during the cooling operation	-
PHDPC			R32 Hydrosplit, R32 Split Hydro Box (NK5 suffix), R410A Split Hydro Box (NK5 suffix)				
Cover plate	PDC-HK10		R32 Hydrosplit Hydro Box, R32 Hydrosplit IWT, R32 Split Hydro Box, R32 Split IWT, R410A Split Hydro Box	-	To fill the blank space of the indoor unit front panel when the remote controller is relocated indoors.	-	

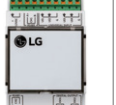
Accessories Provided by LG

Category	Model name	Model number	Figure	Applicable product	Relevant function	Purpose	Feature
Remote controller	Wired remote controller	PREMTW101		All Therma V products	2 remote control	To control the AWHP using two remote controllers (an additional remote controller)	<ul style="list-style-type: none"> New modern design 4.3 inch color LCD display Information displayed with simple graphic, icon & text Built-in temperature sensor Size (W x H x D): 120 x 120 x 16 Extension cable (PZCWRC1, 10 m) and 2 remote cable (PZCWRC2, 0.25 m) are included
Central controller	AC Ez Touch ¹⁾	PACEZA000		All Therma V products	Centralized control	To control the AWHP using LG central controller	<ul style="list-style-type: none"> 5 inch color display User-friendly control with iconographic interface (touch screen) Max. 32 unit control Total 200 schedule events (weekly / monthly / yearly / exception day) Operation history Remote controller lock (all, temp, mode) PC access supported (IPv6 supported) DI 1 ea (emergency stop only) Size (W x H x D): 137 x 121 x 25
	AC Smart 5 ¹⁾	PACSSA000 (Smart 5)					<ul style="list-style-type: none"> 10.2 inch color display User-friendly control with iconographic interface (touch screen) Max. IDU 64 Total 100 schedule events (weekly / monthly / yearly / exception day) History / operation trend Interlock with 3rd party equipment (ACS IO, ACU IO module is needed) Error alarm by e-mail Remote controller lock (all, temp, mode) Map view (visual navigation) Web access supported with HTML5 (PC, smartphone, tablet) DI 2 ea, DO 2 ea BACnet IP/modbus TCP protocol support Size (W x H x D): 253.2 x 167.7 x 28.9
	ACP 5 ¹⁾	PACPSA000 (ACPS)					<ul style="list-style-type: none"> Web access controller Max. 128 unit control Total 100 schedule events (weekly / monthly / yearly / exception day) History / operation trend Interlock with 3rd party equipment (ACS IO, ACU IO module is needed) Error alarm by e-mail Remote controller lock (all, temp, mode) Map view (visual navigation) DI 10 ea, DO 4 ea BACnet IP/modbus TCP protocol support Lonworks protocol support* (max. 64 unit control) Size (W x H x D): 270 x 155 x 65

* For using Lonworks protocol, only ACP 5 provides interface for BMS integration, and, need to U60FT module between ACP 5 and BMS system interface between Lonworks FT-10 BMS and LG HVAC unit. U60FT should be purchased separately from 3rd party supplier. Please contact regional LG office for more detailed information.

Category	Model name	Model number	Figure	Applicable product	Relevant function	Purpose	Feature
Gateway	Modbus RTU gateway	PMBUSB00A		All Therma V products	Centralized control	To communicate and control through the central controller (providing modbus RTU connection between the AWHP and BMS)	<ul style="list-style-type: none"> Modbus RTU slave (RS485) / 9,600 bps Size (W x H x D): 53.6 x 89.7 x 60.7 Max. 16 IDUs with single module / Max. 64 IDUs with 4 modules Power: DC 12 V
	PI485 gateway for Therma V	PP485A00T				To communicate and control through the central controller (converting LG protocol to RS485 protocol)	<ul style="list-style-type: none"> 1 for each outdoor unit Power: supplied by outdoor unit
Dry contact	Simple dry contact	PDRYCB000		All Therma V products		To connect between the AWHP and external devices to control various functions	<ul style="list-style-type: none"> 1 Set per 1 unit 1 Input contact for turning on/off Input power: 220 ~ 240 V 2 output contacts <ul style="list-style-type: none"> Operation status Error status
	Dry contact for thermostat	PDRYCB320					<ul style="list-style-type: none"> 1 Set per 1 unit Non voltage or 12 ~ 24 V 8 digital input contacts for thermostat <ul style="list-style-type: none"> On/off, operation mode, DHW heating Emergency mode, silent mode 2 Output contacts <ul style="list-style-type: none"> Operation status Error status
ETC	LG Wi-Fi modem	PWFMD200		All Therma V products	Wi-Fi control via LG ThinQ	To control the AWHP via a smartphone	<ul style="list-style-type: none"> Basic control function <ul style="list-style-type: none"> On/off, operation mode, set temp DHW heating and set temp Weekly on/off schedule Error status check Frequency: 2.4 GHz IEEE 802.11b/g/n supported
	Cloud gateway ¹⁾	PWFMD200		R32 Monobloc S, R32 Split IWT, New Hydro Box for Split & Hydrosplit	LG BECON cloud service	For remote control, monitoring and diagnosis	<ul style="list-style-type: none"> Max 16 indoor units RS485: 1 channel (LGAP) Wired/wireless IAN Power: 12 V DC Size (W x H x D): 120 x 120 x 29
	Meter interface	PENKTH000		All Therma V products	Energy monitoring	To measure production / consumption power	<ul style="list-style-type: none"> Energy meter interface to monitor Electricity and Heat energy <ul style="list-style-type: none"> Max. 3 watt Hour meter Max. 1 heat meter Pulse width: 40 ms ~ 100 ms Modbus RTU comm. with Therma V <ul style="list-style-type: none"> 2 wire RS485 / 9600 bps Power: DC 12 V Size (W x H x D): 54 x 90 x 61

Note

1. PI485 Gateway (PP485A00T) should be installed on outdoor unit to use the central controller and cloud gateway.

LG Wi-Fi Modem

PWFMDD200 ENCXLEU

Access LG Therma V anytime and from anywhere with a Wi-Fi equipped device. LG's exclusive home appliances control app (LG ThinQ) offers simple operation and various functions.

- On / Off
- Operation mode selection
- Current temperature
- Set temperature
- On / Off reservation scheduling
- Energy monitoring
- ESS monitoring
- Silent mode reservation
- Holiday mode
- Quick DHW heating

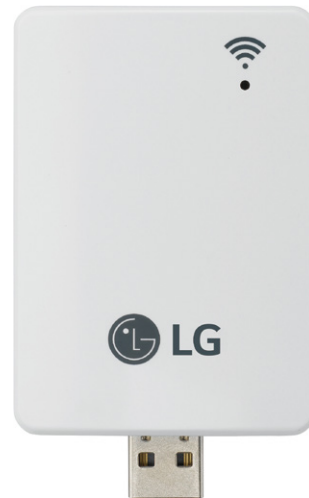

Model name	PWFMDD200
Size (mm)	46 x 68 x 14
Interfaceable products	All Therma V line-ups
Connection type	Indoor unit 1 : 1
Communication frequency	2.4 GHz
Wireless standards	IEEE 802.11b/g/n
Mobile application	LG ThinQ (Android v4.1 (Jellybean) or higher, iPhone iOS 9.0 or higher)
Optional extension cable	PWYREW000 (10 m extension)

Note

1. Functionality may be different according to each Indoor model.
2. User interface of application shall be revised for its design and contents improvement.
3. Application is optimized for smartphone use, so it may not be well functioning with tablet devices.
 - For the compatibility with indoor unit, please contact regional office.

Domestic Hot Water Tank

OSHW-200F AEU
OSHW-300F AEU
OSHW-500F AEU
OSHW-300FD AEU



Single coil

Double coil

Technical specification		Unit	OSHW-200F	OSHW-300F	OSHW-500F	OSHW-300FD
General characteristics	Water volume	ℓ	200	300	500	300
	Diameter	mm	640	640	810	640
	Height	mm	1,350	1,850	1,900	1,850
	Empty weight	kg	61	100	146	106
	Tank materials	-	STS : F18	STS : F18	STS : F18	STS : F18
	Color	-	Grey (RAL 7035)	Grey (RAL 7035)	Grey (RAL 7035)	Grey (RAL 7035)
Specification of electric back up	Additional electric heater	W	2,400	2,400	2,400	2,400
	Power supply	V, ∅, Hz	230, 1, 50 (60)	230, 1, 50 (60)	230, 1, 50 (60)	230, 1, 50 (60)
	Adjustable thermostat	°C	0 - 90	0 - 90	0 - 90	0 - 90
Specification of heat exchanger	Exchanger type	-	Internal single coil	Internal single coil	Internal single coil	Internal double coil
	Material exchanger	-	STS : F18	STS : F18	STS : F18	STS : F18
	Maximum water temp.	°C	90	90	90	90
	Coil surface	m ²	2.3	3.1	4.8	3.1 + 1
Water connections	Heat pump inlet	inch	1 BSP female	1 BSP female	1 ¼ BSP female	1 BSP female (upper coil)
	Heat pump outlet	inch	1 BSP female	1 BSP female	1 ¼ BSP female	1 BSP female (upper coil)
	Solar inlet	inch	-	-	-	¾ BSP Female (lower coil)
	Solar outlet	inch	-	-	-	¾ BSP Female (lower coil)
	City water inlet	inch	¾ BSP male	¾ BSP male	1 BSP male	¾ BSP male
	Hot water outlet	inch	¾ BSP female	1 BSP female	1 BSP female	1 BSP female
Energy efficiency class (A+ to F scale)	-	B	B	B	B	
Standing heat loss	W	61	70	83	70	

Mandatory optional accessories	
Domestic hot water tank installation kit	PHLTA (Hydro Box for Split & Hydrosplit), PHLTB (Monobloc), PHLTC (old Hydro Box for R410A Split 3 ∅ - HN1639 NK3)
Optional accessories	
Thermostatic mixing valve (3/4" DN20)	OSHA-MV
Thermostatic mixing valve (1" DN25)	OSHA-MV1
3 way valve	OSHA-3V

THERMA V™ ACCESSORIES

Combined Test with DHW Tank

LG has conducted a combination test of Therma V with DHW tanks in accordance with EN16147 and obtained an ErP label for packages in accordance with the European nZEB regulations.

• R32 Monobloc S (5 ~ 16 kW) + OSHW-200 F

- HM051MR U44
- HM071MR U44
- HM091MR U44
- HM121MR U34
- HM141MR U34
- HM161MR U34
- HM123MR U34
- HM143MR U34
- HM163MR U34



Model	Therma V line-up	R32 Monobloc S (5, 7, 9 kW)	R32 Monobloc S (12, 14, 16 kW)
	Model name	HM051MR U44 HM071MR U44 HM091MR U44	HM121MR U34 HM141MR U34 HM161MR U34 HM123MR U34 HM143MR U34 HM163MR U34
	DHW tank	OSHW-200F AEU	OSHW-200F AEU
Declared load profile		L	L
Average climate	Water heating eff. class	A+	A+
	Water heating efficiency (η_{WH})	144 %	146 %
	COP _{DHW}	3.1	3.2
	Annual energy consumption	712 kWh	701 kWh
Warmer climate	Water heating eff. class	A++	A++
	Water heating efficiency (η_{WH})	174 %	166 %
	COP _{DHW}	3.8	3.6
	Annual energy consumption	588 kWh	616 kWh
Colder climate	Water heating eff. class	A	A
	Water heating efficiency (η_{WH})	87 %	101 %
	COP _{DHW}	1.9	2.2
	Annual energy consumption	1,172 kWh	1,011 kWh
Energy label			

