

2021
AIR CONDITIONER

LG HVAC SOLUTION



2021

AIR CONDITIONER



Distributed by

LG Electronics

<http://www.lg.com>
<http://partner.lge.com>

EUROPE SALES INFRASTRUCTURE

-  Europe B2B Regional Head Office
-  National Sales Office
-  Air Conditioning Academy
-  European Distribution Center
-  Europe Energy Lab
-  Production Site

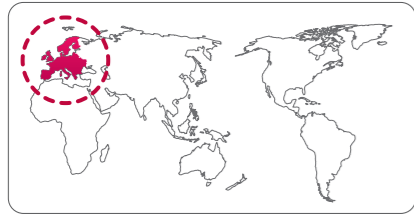

GLOBAL PRODUCTION SITE



LG Energy Labs in Europe

LG Energy Labs are driven to fulfill the commitment of meeting all the requirements regarding energy efficiency and environmental demands. Each LG Energy Lab is an innovative site dedicated to provide essential commercial and residential products in heating, ventilation and the latest energy efficient air conditioning solutions. Additionally, as a showcase, the LG Energy Lab is equipped with complete monitoring and control systems. The performance of all products are tracked and analyzed by a team of Research and Development engineers based in France, Finland and Korea, ensuring maximum efficiency and reliability during the complete products' lifecycle.



European Air Conditioning Distribution Center

LG's European Air Conditioning Distribution Center is centralised in Oosterhout, the Netherlands. Supplying and delivering products to 15 countries in Europe, this Distribution hub has contributed to quick and seamless delivery, direct shipping for smaller orders and bespoke delivery to air conditioners. The hub tries to manage inventory efficiency by complying with the LG EU's established inventory pool.

TOTAL HVAC SOLUTION PROVIDER

Since manufacturing Korea's first air conditioner exclusively designed for residential use in 1968, LG has been a pioneer of air conditioning innovation. Encouraged by LG's technological leadership in the residential air conditioning sector since the late 1990s, LG moved into the commercial air conditioning sector.

LG has established itself as an exemplary HVAC and energy solutions provider, investing in new technologies, with the addition of chiller, VRF systems and building management systems (BMS) to its comprehensive product portfolio. Alongside its wide range of innovative solutions, the LG promise is to deliver unparalleled customer service.

LG produces expert air conditioning professionals at its academic centers, of which there are nearly 80 worldwide. These academic centers provide workshops and training programs that offer excellent hands-on experience. Additionally, LG provides advanced and highly sophisticated tools for HVAC system engineers and installers, including its time saving LG Air Conditioner Technical Solution (LATS) software. LATS allows LG to support clients with draft energy estimation and energy modeling, model selection and design, lifecycle cost analysis and more to ensure a seamless process from planning to execution. LG also operates several state-of-the-art R&D facilities all across the planet.

Made Better with LG ThinQ™

With most people living lives that are more hectic than ever before, we see the enormous potential benefits new technologies will bring to the home. LG ThinQ links smart products together so that they can work in unison to make your home smarter and more connected. New levels of control and convenience simplify everyday life and free up time so that you can stay focused on what matters. Furthermore, transformative features and services with artificial intelligence will take home evolution one step further. LG ThinQ will provide more personalized and optimized solutions by learning your needs and preferences through its wide range of products. Get more done while doing less. LG ThinQ's Personalized Solution, Proactive Advice, Maximum Efficiency and Intuitive Control deliver an elevated, more intelligent lifestyle. LG ensures its intelligent offerings, AI-powered products and services unlock new roles for homes that can play an important role for truly smart living. Think Wise. Be Free.

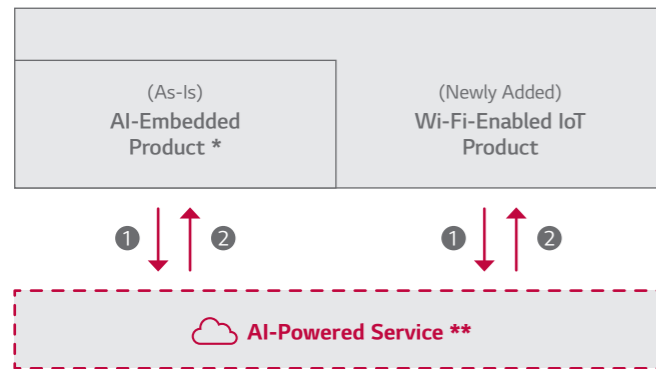

- 1 Understanding users via data collection
- 2 Providing tips & solutions through AI data analytics

* Previous LG ThinQ products-Requirement : evolving products with vocal/visual/product intelligence
 ** Examples of AI-Powered Service : -Usage guide/tips, Predictive maintenance, Auto/semi-auto setting (TBD)

Consumer Benefits

Intuitive Control
 LG ThinQ adds convenience to your daily life by simplifying daily tasks. The LG ThinQ experience is reliable, flexible and effortless from setup to control and beyond. LG ThinQ products can be controlled from anywhere and at any time with simple voice-commands and a tap of the innovative ThinQ smartphone application. Meaning anywhere can be your home.

Maximum Efficiency
 LG ThinQ minimizes energy consumption and can even track your energy usage and expenditure. Beyond mechanical advancements, LG ThinQ provides unrivaled energy efficiency by utilizing a combination of analytics, sensors and usage data.

Personalized Solution
 LG ThinQ provides tailored recommendations and optimal settings, with your needs and preferences taken into account. Thanks to the power of AI, the same products can offer different experiences depending on your unique tastes and specific situations.

“
LG ThinQ:
A Brand for Products and
Services Incorporating
Advanced AI Technologies
 ”



010

010 - 143

RESIDENTIAL

- WALL MOUNTED 022
- PORTABLE AIR CONDITIONER 060
- HEAT PUMP WATER HEATER 068
- MULTI SPLIT 082

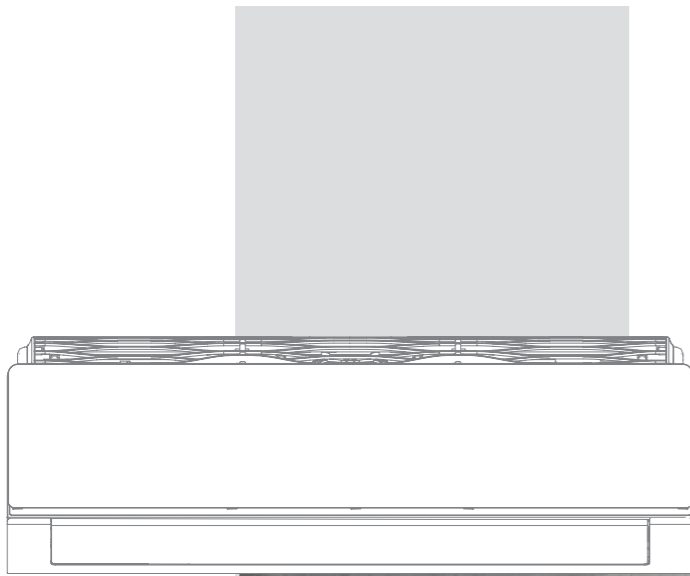

144

144 - 275

COMMERCIAL

- SINGLE SPLIT 148

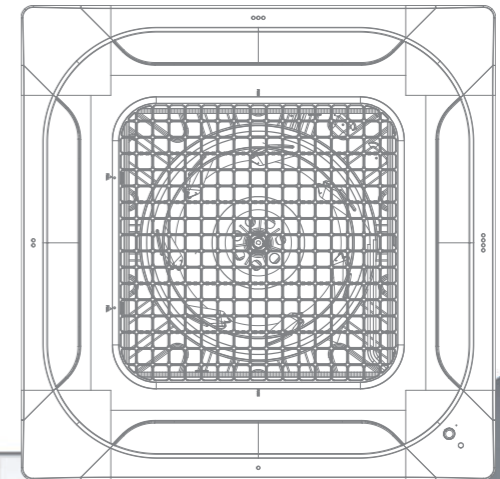

ADVANTAGE OF AIR CONDITIONER

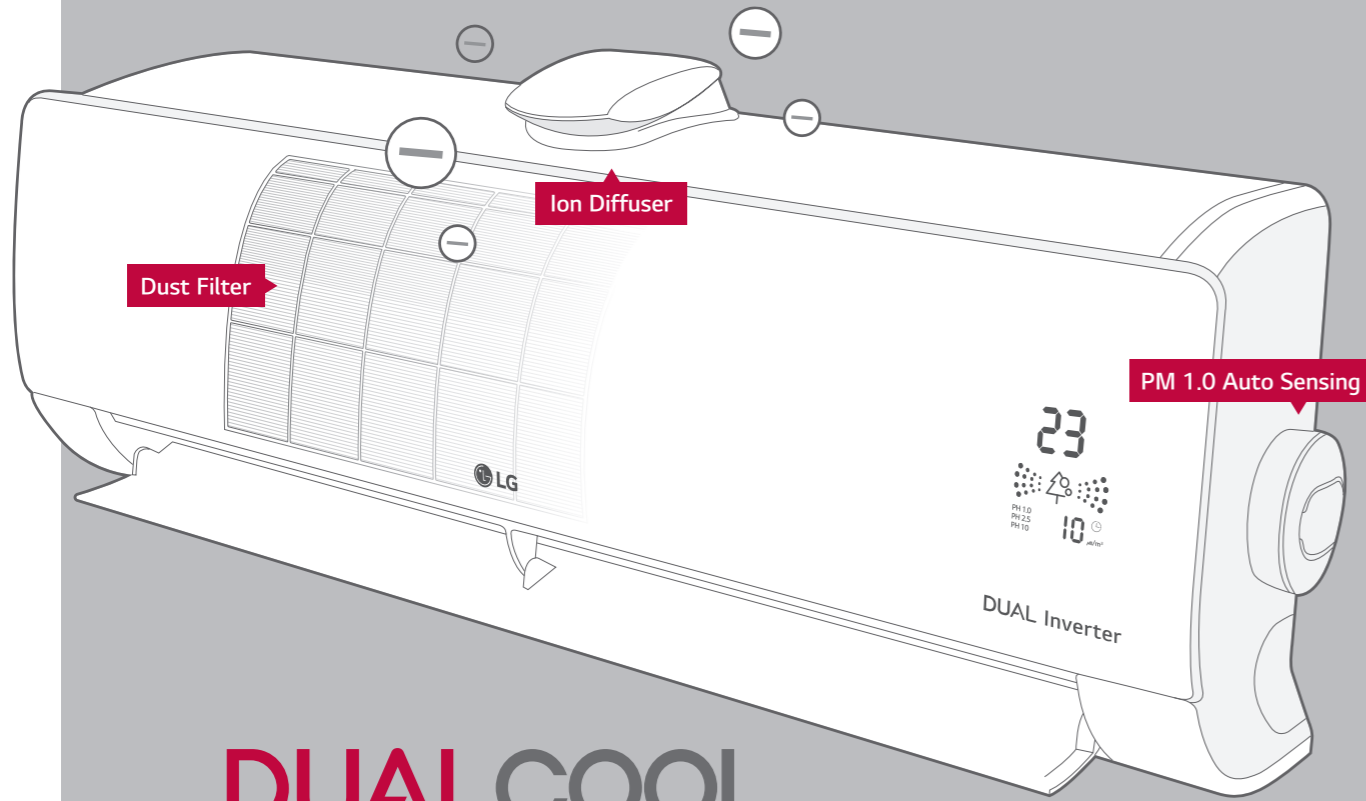

DUALCOOL
with Air Purification

SPACE ART DESIGN

Unique designs that enhance your interior's effects

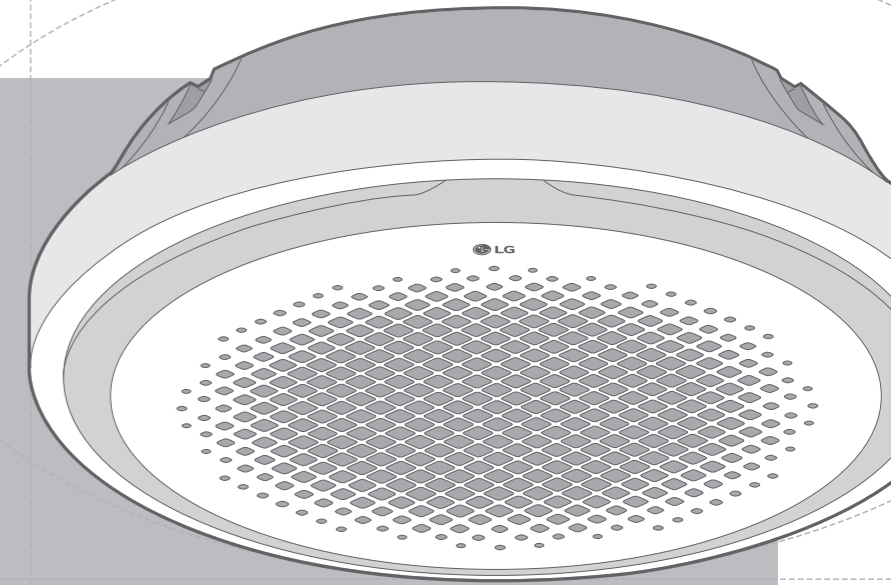

EASY AND SIMPLE VOICE CONTROL

Easier and more convenient!

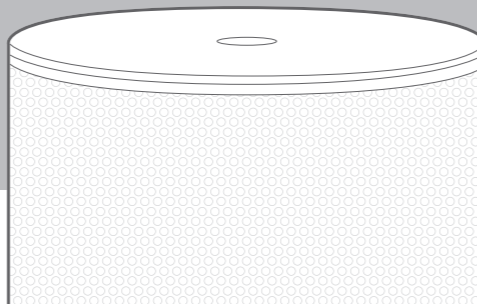

ADVANCED TECHNOLOGIES R1 COMPRESSOR

Revolutionary Scroll Compressor is applied for high-efficiency and reliability

HiPOR™

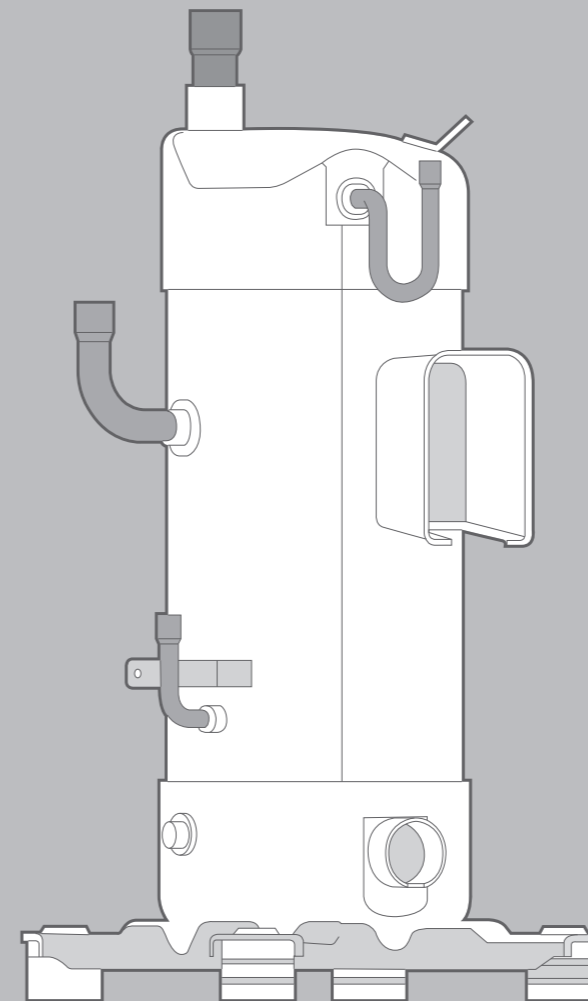
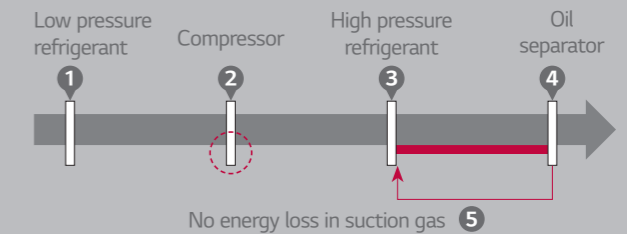

10 YEAR WARRANTY EXTREME DURABILITY

Reliable Air Conditioner



010-145

RESIDENTIAL

WALL MOUNTED / PORTABLE AIR CONDITIONER / HEAT PUMP WATER HEATER / MULTI SPLIT

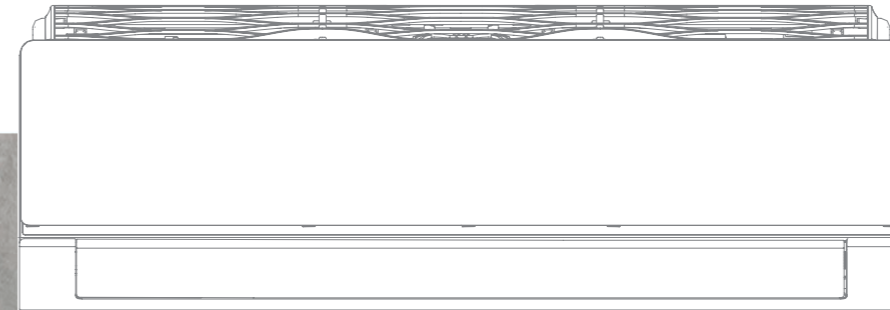

Enjoy A New Level Of Fresh Air

AirCare Complete System™

Today's air conditioners, as well as fast cooling & energy saving are now basic, and all brand communicate each benefit of filtering bacteria, dust and mold and purifying contaminated air. However, it's not differentiating to consumer. LG's AirCare Complete System™ refers to a technology that combines UVnano™ on top of filtering system to appeal for differentiation.



What is **AirCare Complete System™** ?

Filtering System

+

UVNano™

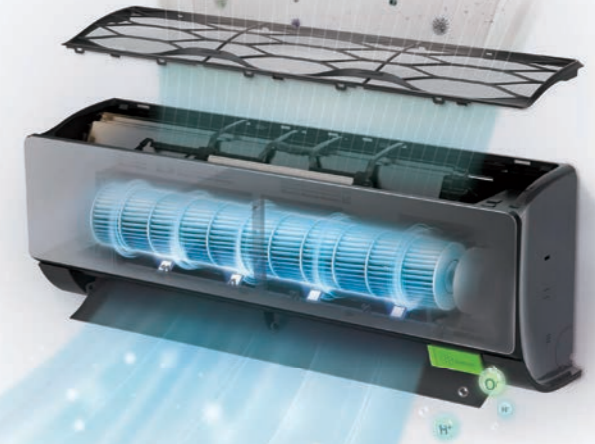

Total Care Even inside

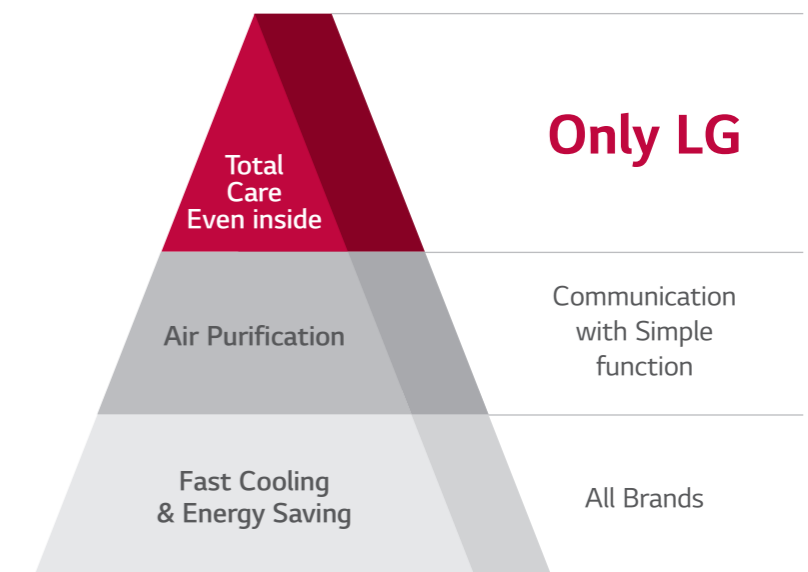

Enjoy A New Level Of Fresh Air

AirCare Complete System™

LG DUALCOOL, LG ARTCOOL brings the freshness of nature to your home. The all-new AirCare Complete System uses a filtration process with UVnano™ and Ionizer that removes fine dust and even bacteria, ensuring the breeze around you is always fresh. ensuring the air you breathe is always fresh. Breathe in the nature - right at home.

ART COOL™ MIRROR

Auto Cleaning

Automatically dries out any moisture collected in the unit to prevent the formation of dirty and harmful scraps.

Pre-Filter™

Traps big dust particles from the start.

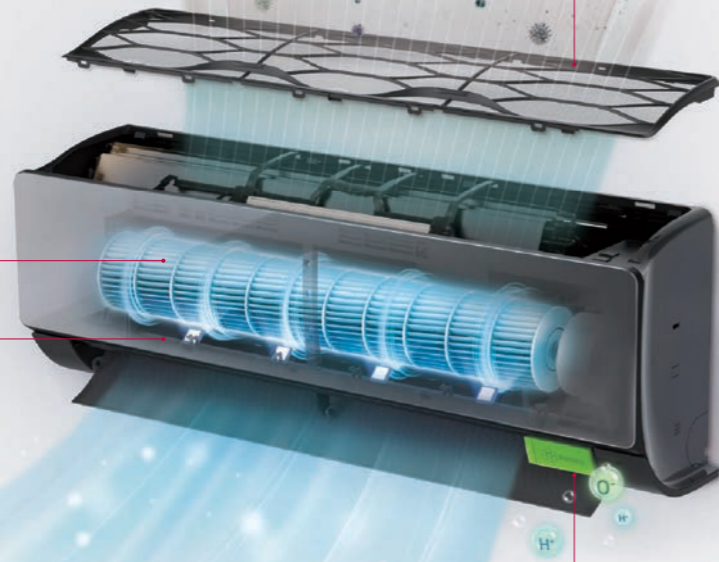

UVnano™

Keeps your fan 99.99% bacteria-clean with UV LED light to ensure fresh and clean air is delivered.

Plasmaster™ Ionizer⁺

Stay cool and keep the air healthy by removing 99.9%* of adhering bacteria and deodorizing.

DUALCOOL™ DELUXE

Auto Cleaning

Automatically dries out any moisture collected in the unit to prevent the formation of dirty and harmful scraps.

Pre-Filter™

Traps big dust particles from the start.

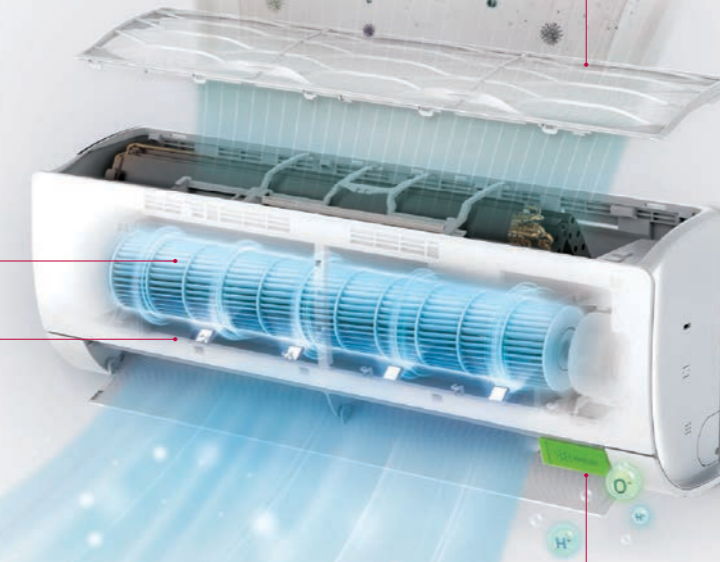

UVnano™

Keeps your fan 99.99% bacteria-clean with UV LED light to ensure fresh and clean air is delivered.

Plasmaster™ Ionizer⁺

Stay cool and keep the air healthy by removing 99.9%* of adhering bacteria and deodorizing.

Anytime, Anywhere!

DUALCOOL ThinQ™

with Voice Control



OK Google,
turn on the air conditioner.



Sure, turning on



Key Feature

Enhance your daily life with LG ThinQ

Cool home when you arrive
"It would be wonderful if my place is already cool when I arrive."

Check electricity bills throughout the month
"How much have I been using the AC lately?"

Switch off AC after you've left
"Oh no! Did I remember to turn off the AC?"

No need to search for the remote control your AC with your phone
"Where's the remote control? I don't want to move a inch from my bed"

LG ThinQ™

Voice control for a better life

- Very intuitive : It has never been that simple to control a device.
- Accessible to everyone : Young to elder people. Increase your comfort by asking so.
- Time saving : Don't look for the remote control anymore, just say it with your voice instead.

Simple voice control, time saving & accessible to everyone

No need to wander around searching for your AC's remote control. DUALCOOL™ models are also compatible with AI speakers such as LG ThinQ with Google Assistant, Google Home and more. From now on, don't bother pressing any buttons. Use your voice instead.

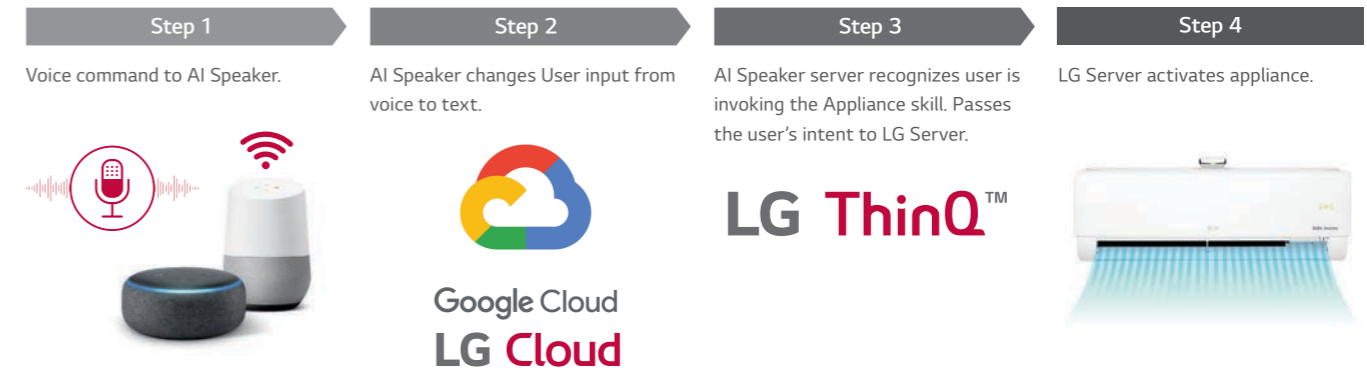

※ LG ThinQ is now renamed to LG ThinQ.
 ※ Smart features and voice assistant product may vary by country and model Check with your local retailer or LG for service availability.

Don't Worry! Now, Breathe Healthily

DUALCOOL

with Air Purification



Cooling + Heating + Air purification
Comfort 365 days

Removes Ultrafine dust
Ion Diffuser & Micro Dust filtering system

Real-time control & monitoring
LG ThinQ APP

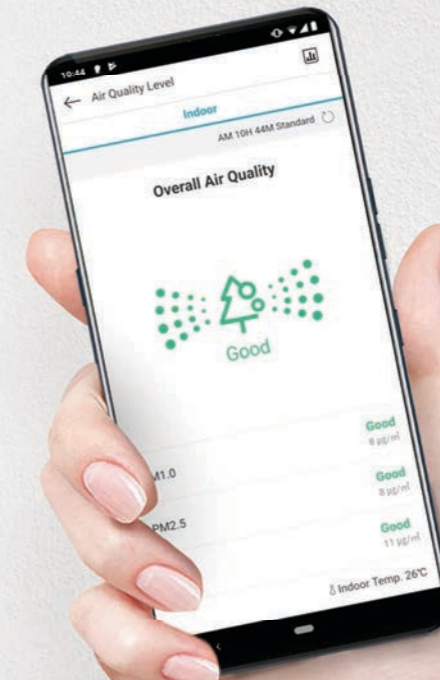

Key Feature

Air Conditioner and Air Purifier in One

PM1.0 sensor is automatically activated and filtration system uses 5 million ions to capture and remove microscopic dust particles.



※ Formerly branded LG ThinQ is now LG ThinQ.
※ Smart features and voice assistant product may vary by country and model. Check with your local retailer or LG for service availability.

Reduction of 0.1 μ m (1/500 of hair) Micro Dust Up to 99.9%

Micro dust 0.1 μ m (100nm) can be removed up to 99.9% within 109 minutes.

Test Result

0.1 μ m (100nm) Air Purifying Performance Test

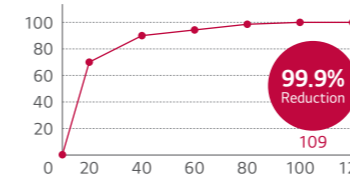

※ Test Condition
- Test Room size (W x H x D) : 4,000 x 3,000 x 2,500 (mm), Test model S3NM12JA1YB

Air Purification with Coverage Up to 29m²

Feel the difference in the air with coverage up to 29m².

Test Result

PM 2.5 Air Purifying Capability Test



※ Coverage vary depending on the product capacity.
Testing by TUV Verification, SJ : 27.4m², SK : 29.3m²

Four Seasons of Breeze

Enjoy comfort in all four seasons with cooling, heating, and air purification.

Comfort 365 days

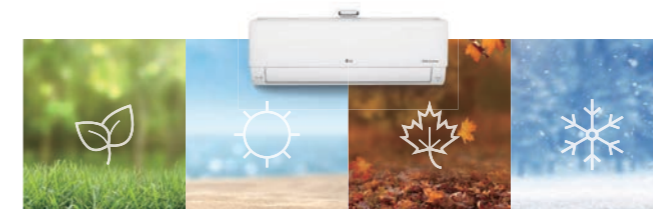









Conveniently Manage Air Quality with LG ThinQ App

Let's check now! History of your air quality by LG ThinQ.



INDOOR UNITS LINE-UP



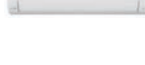
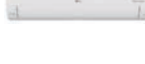

○ Single Split Only ● Compatible ● Multi Split Only

MODEL	kBTu kW	5	7	9	12	15	18	24	
		1.5	2.1	2.6	3.5	4.2	5.3	7.0	
ARTCOOL	Gallery				○ A09FT NSF	○ A12FT NSF			
	Mirror			● AM07BH NSJ	○ AC09BH NSJ	○ AC12BH NSJ	○ AC18BH NSK	○ AC24BH NSK	
DUALCOOL	Prestige				○ F09MT NSM	○ F12MT NSM			
	Air Purification				○ AP09RT NSJ	○ AP12RT NSJ			
	Deluxe			● DM07RH NSJ	○ DC09RH NSJ	○ DC12RH NSJ	○ DC18RH NSK	○ DC24RH NSK	
	Deluxe 2				○ DC09RT NSJ	○ DC12RT NSJ			
	Standard Plus		● PM05SP NSJ	● PM07SP NSJ	○ PC09SQ NSJ	○ PC12SQ NSJ	● PM15SP NSJ	○ PC18SQ NSK	○ PC24SQ NSK
	Standard 2			● MS07ET NSA	○ S09ET NSJ	○ S12ET NSJ	○ S18ET NSK	○ S24ET NSK	
	Standard				○ S09EQ NSJ	○ S12EQ NSJ	○ S18EQ NSK	○ S24EQ NSK	
	Standard 3				○ S09EH NSA	○ S12EW NSJ			

※ Refer to multi split line up for 5, 7, 15 kBTu indoor unit connection.

OUTDOOR UNITS LINE-UP

○ Single Split Only ● Compatible ● Multi Split Only

MODEL	kBTu kW	9	12	14	16	18	21	24	27	30
		2.6	3.5	4.1	4.7	5.3	6.2	7.0	7.9	8.8
ARTCOOL	Gallery		○ A09FT UL2	○ A12FT UL2						
	Mirror		○ AC09BH UA3	○ AC12BH UA3		○ AC18BH UL2		○ AC24BH U24		
DUALCOOL	Prestige		○ F09MT U24	○ F12MT U24						
	Air Purification		○ AP09RT UA3	○ AP12RT UA3						
	Deluxe		○ DC09RH UL2	○ DC12RH UL2		○ DC18RH UL2		○ DC24RH U24		
	Deluxe 2		○ DC09RT UA3	○ DC12RT UA3						
	Standard Plus		○ PC09SQ UA3	○ PC12SQ UA3		○ PC18SQ UL2		○ PC24SQ U24		
	Standard 2		○ S09ET UA3	○ S12ET UA3		○ S18ET UL2		○ S24ET U24		
	Standard		○ S09EQ U	○ S12EQ UA3		○ S18EQ UL2		○ S24EQ U24		
	Standard 3		○ S09EH UA3	○ S12EW UA3						

WALL MOUNTED

ARTCOOL / PRESTIGE / DUALCOOL with Air Purification / DELUXE / STANDARD PLUS / STANDARD



				CORE TECH	PERFECT HEALTHCARE					SMART
				Dual Inverter Compressor	UV nano™	Ultrafine Dust Sensing (PM 1.0)	Plasmaster Ionizer PLUS	Auto Cleaning	Voice Control	
		Cooling	Heating							
ARTCOOL	Gallery	9k	12k							
	Mirror	9k	12k	18k	24k	7k ⁴⁾	Only for Multi			
DUALCOOL	Prestige	9k	12k							
	Air Purification	9k	12k							
	Deluxe	9k	12k	18k	24k	7k ⁴⁾	Only for Multi			
	Deluxe 2	9k	12k			7k ⁴⁾	Only for Multi			
	Standard Plus	9k	12k	18k	24k	5k / 7k / 15k ⁴⁾	Only for Multi			
	Standard 2	9k	12k	18k	24k	7k ⁴⁾	Only for Multi			
	Standard	9k	12k	18k	24k					
	Standard 3	9k	12k							

SMART		ENERGY EFFICIENCY		COMFORT				EXTREME DURABILITY	FAST COOLING & HEATING		MULTI
Embedded Wi-Fi	Smart Diagnosis	Active Energy Control	Energy Display	Comfort Air (Indirect Air)	4 Way Swing	Low Noise 19dB	Silent Mode 3dB	Gold Fin™	Jet Cool	Fast Heating	Compatible
					3 way						
								Black Fin			
								Black Fin			
								Black Fin			
					(18/24k Only)						

Feature may vary for each model.
 1. When connected to Multi Outdoor unit, Silent Mode 3dB is working by simply setting the dip switch on the PCB of the outdoor unit.
 2. When combines with 40kBtu, Cooling A+, Heating A
 3. Wi-Fi Ready : can be connected by using Wi-Fi controller (PWFMD200)
 4. Please refer to the specifications of Multi outdoor units.

powered by
DUAL Inverter Compressor™

What is the Dual Inverter Compressor?

A compressor is the heart of an air conditioner, and monitoring whether it works properly, effectively, or noisily can cause stress as well as cost money. LG's Dual Inverter Compressor provides an effective solution, resulting in an air conditioner that cools faster, lasts longer, and operates quieter than conventional models.



Product Reliability Improvement

The Dual Inverter Compressor reduces the vibration and with it the sound pressure levels. The reduction in vibration reduces the possibility of fractures occurring in the the surrounding pipework.

How it Works

Varied-Speed Dual Rotary

A compressor motor with a wider rotational frequency that is energy efficient and has a higher volumetric quick cooling capacity than any conventional compressors.

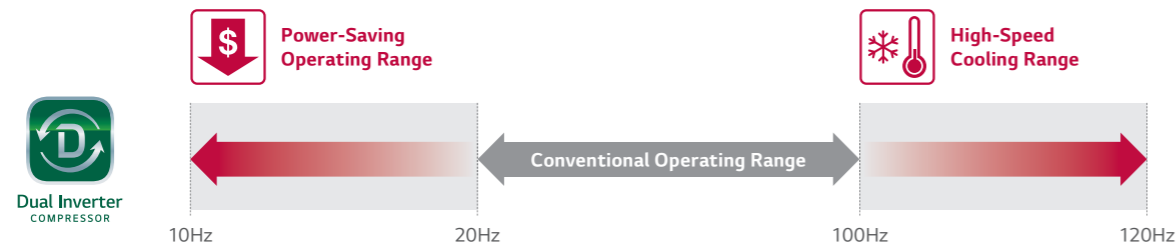

R32 Refrigerant

R32 refrigerant is a more eco-conscious refrigerant than the previous generation of refrigerants.

Pain Point

Due to accelerated global warming and the destruction of the ozone layer, various international conventions and meetings are held to enhance restrictions to the use of refrigerant or enforce the use of eco-conscious refrigerants. In order to reduce environmental destruction, refrigerant R32 is internationally acclaimed for being eco-friendly. This low volume refrigerant is more efficient than conventional refrigerants and boasts a 68% reduced global warming potential.



Benefit

Eco-conscious refrigerants reduce environmental pollution.

How it Works

Utilizing a small amount of the R32 refrigerant also qualifies it to be a highly green efficient system.

Alleviate Global Warming & Ozone Layer Destruction

R32 efficiently works even in small volume compared to existing R410A refrigerant, which decreases potential hazard of global warming.

	R410A	R32
Composition	Blend of R32 50% + R125 50%	Pure R32 (No blend)
GWP (Global Warming Potential)	2087.5	675

High Compressibility

R32's high compressibility rate gives more powerful cooling performance and efficiency compared to existing refrigerant R22 and R410A.

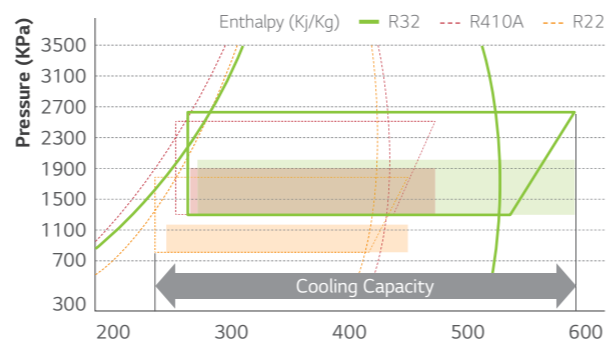

UVnano™

New UV LED technology "UVnano" is applied to LG DUALCOOL, and it keeps the fan (inside of indoor unit) 99.99% bacteria-clean with ultraviolet light to ensure that the air passing through is clean too.

※ UVnano is an integrated marketing name that applies LG Electronics' entire home appliances and it is a compound of the words UV(ultraviolet) and nanometer (unit of length).

What is UVnano and How It Works?

- Emit Ultraviolet rays of UVC wavelength directly damage the DNA of microorganisms (bacterial/MOLD/virus), making it impossible to multiply.
- High absorption into DNA at 260 to 270 nm wavelengths

DNA Absorption Efficiency by Wavelength

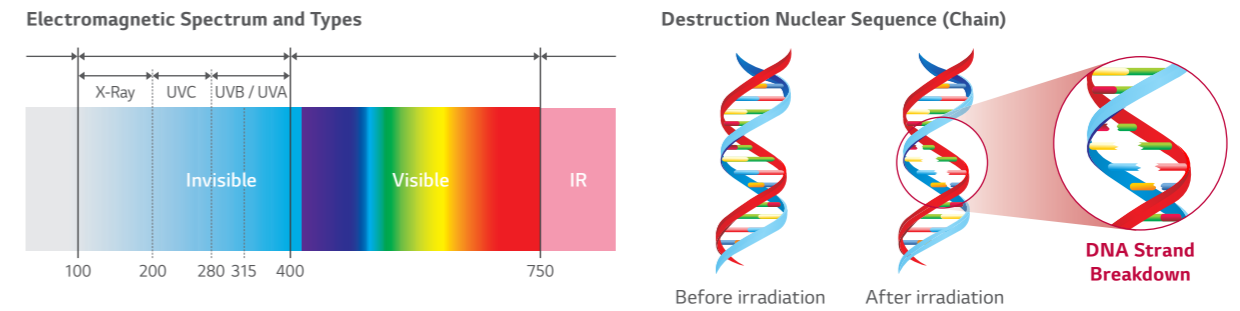

Ultraviolet light is a form of radiation which is not visible to the human eye. It's in an invisible part of the "electromagnetic spectrum". Radiated energy, or radiation, is given off by many objects: a light bulb, a crackling fire, and stars are some examples of objects which emit radiation.

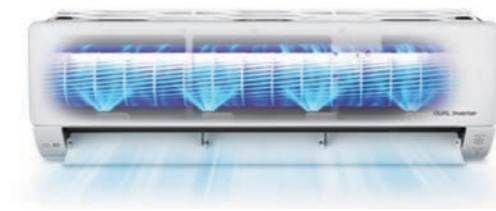

UVC Applied Product

LG Product



Various Product Lines

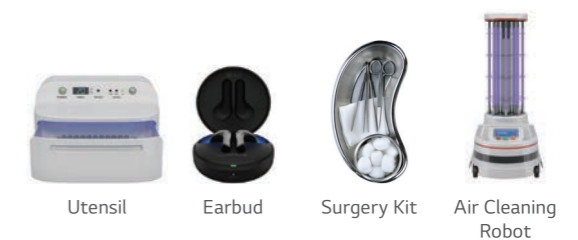

Benefit & Verification

Keep the fan 99.99% bacteria-clean for a cleaner breeze.

Test Result



Remove up to **99.99%** of bacteria-clean from the fan.



- ※ Test Condition
- Test Model : S3NM12JL1GA(SJ), S3NM24K21GA(SK)
- Test Standard : LG test method with referenced to ISO 20743:2007
- Bacteria : Staphylococcus aureus, Staphylococcus epidermidis, Klebsiella pneumoniae

Plasmaster™ Ionizer⁺

The powerful Plasmaster Ionizer⁺ protects you from bad odors and Escherichia coli and Staphylococcus in the surface with over 3 million ions to Reduce to make a safer, and cleaner environment.

※ Specifications may vary for each model.
 ※ Depending on the experimental conditions.

How It Works

Reduction and Deodorization (Utilizes Over 3 Million Ions)

Plasmaster Ionizer⁺ reduces E.coli and Staphylococcus in the surface with over 3 million ions.

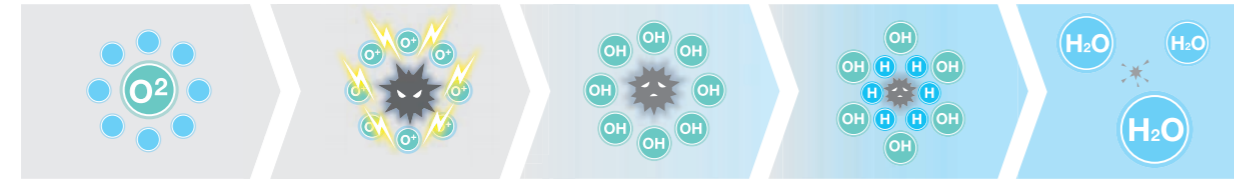

Ion Cluster Generation	Surrounding Harmful Substances	OH Radical Production	Chemical Reaction	Sterilization
Ions are released into air	H- and O- bond to harmful particles	OH radicles inactivate harmful substances	OH radicles bond with H particles	H ₂ O molecules are produced

Test Result

Reduction Performance Evaluations

Reduce Bacteria E.coli over 99.9% in 30 min.

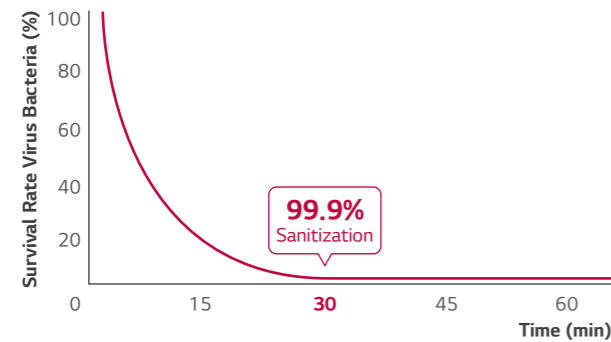

※ Test Conditions :
 Space : 52m³ Chamber (measuring with the specimen in the center of test chamber)
 Temperature & Humidity : Normal
 Bacteria : E coil colon bacillus
 Tested by Intertek

Sterilize staphylococcus over 99.6% in 60 min

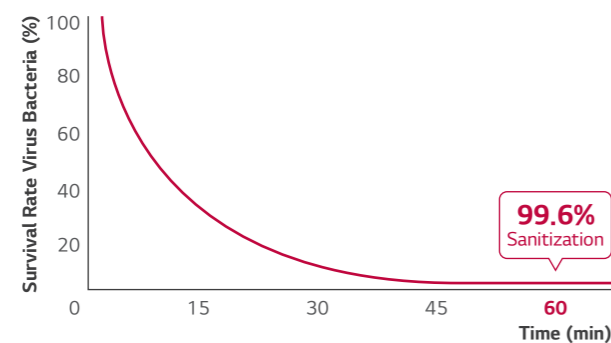

※ Test Conditions :
 Space : 52m³ Chamber (Measuring with the specimen in the center of test chamber)
 Temperature & Humidity : Normal
 Bacteria : Staphylococcus Aureus
 Tested by Intertek

Odor strength decrease in 60 minutes

An odor of measured as 2 European odor units (ouE/m³) or less indicates that the level of odor falls within permissible limits.

Odor strength level	Offensive odor substance sensitivity
4. Very Strong	Food waste smell (3.6)
3. Strong	Bathroom smell
2. Moderate	Indoor life smell
1. Light	Mountain smell (1.5)

Odor strength reduces from 3.6 to 1.5, to include airborne odor as well as that on the curtains, clothes and other similar materials.

※ Test conditions : Space : 8m³ Chamber
 Temperature & Humidity : Normal
 Tested by Intertek

PM 1.0 Auto Sensor

As AC turns on, PM 1.0 sensor automatically operates to capture and remove microscopic dust particles including ultra fine dust.

※ Specifications may vary for each model. ※ Depending on the experimental conditions.

- AQI (Air Quality Index) is displayed in unit of 1 within 8-999 µg/m³.
- AQI (Air Quality Index) may continuously change according to changes in the indoor environment.
- Overall cleanliness color is displayed based on the highest contamination level among fine dust (PM10), ultra fine dust (PM2.5), and super ultrafine dust (PM1.0).
- Overall cleanliness color is displayed in 4 levels according to the indoor contamination level.
- If dust concentration is high, the difference between the displayed dust concentration and the actual dust concentration may increase.



During the operation, if you press PM SENSOR button, you can check the indoor cleanliness in each level.

Color	Level	Display standard (µg/m ³)		
		Super ultra fine dust (PM 1.0)	Ultra fine dust (PM 2.5)	Fine dust (PM 10)
Green	Good	12 or less	12 or less	54 or less
Yellow	Normal	13 - 35	13 - 35	55 - 154
Orange	Bad	36 - 55	36 - 55	155 - 254
Red	Very Bad	56 or more	56 or more	255 or more

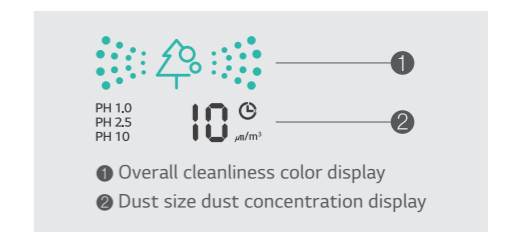

Guide to dust particles' size

- Finedust : Dust with particle size of 10µm or less (Generated from workplace combustion, vehicle exhaust, etc.)
- Ultrafine Dust : Dust with particle size of 2.5µm or less (Composed of ion component, carbon compound, and metal compound)
- Super Ultrafine dust* : Dust with particle size of 1.0µm or less (Cigarette smoke, etc.)

AQI (Air Quality Index) evaluation is carried out with LG standard test dust.

* Minimum capturing size of particle : 0.02µm

※ PM : Particulate matter is the sum of all solid and liquid particles suspended in air many of which are hazardous. This complex mixture includes both organic and inorganic particles, such as dust, pollen, soot, smoke, and liquid droplets.

Auto Cleaning

The interior of the air conditioner is maintained clean by drying off the heat exchanger, then cleaning the interior once more.

※ Specifications may vary for each model.

Pain Point

The main cause of odor within air conditioners is mold and bacteria growing on the heat exchanger. These germs can spread when the heat exchanger is wet.



How It Works

Cleans Filter with Regular Air Flow

The comprehensive auto cleaning function prevents the formation of bacteria and mold on the heat exchanger, providing an enhanced environment.

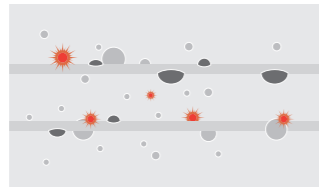

By dehumidifying, the auto cleaning function prevents potentially harmful substances from forming on the surface of the heat exchanger.

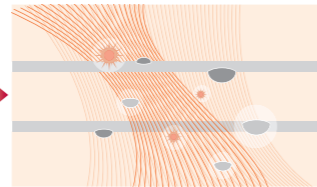

The indoor environment remains odorless with the advanced deodorizing function.



By preventing polluting of the heat exchanger caused by various germs and bacteria.

Benefit

Removes Harmful Particles

Auto Cleaning provides clean air by preventing bacteria, mold and odors that can otherwise accumulate in an indoor unit.

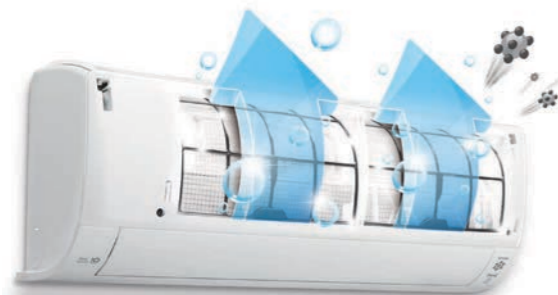

Bacteria Prevention



Odor Prevention



Mold Prevention

Embedded Wi-Fi

Control your air conditioners by using Android or iOS based smartphones.

LG ThinQ



LG ThinQ

Download the LG ThinQ app from Google or Apple app stores.



How it Works

Embedded Wi-Fi modem

Enable "LG ThinQ" on your air conditioner.



By using the embedded Wi-Fi modem, get ready for innovation without boundaries.



Wi-Fi Connectivity

Each individual member of your family can customize the air conditioner temperature and fan speed accordingly and then save the settings in their app to run it later. These settings can be saved for each air conditioner too.

Multiple Devices



※ Can be controlled by multiple users, but not simultaneously.

Multi-Control



Easy Registration and Log-in

Follow the interactive set-up LG Account steps that will activate LG ThinQ's impressive features.

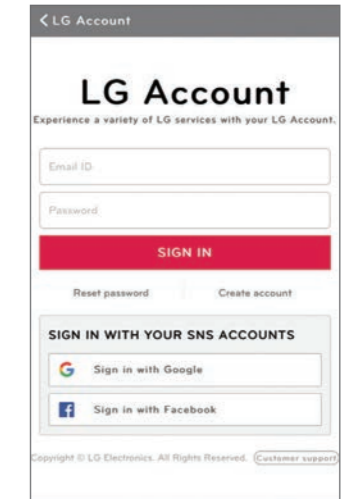

Benefit

Simple operation for various functions



Energy Monitoring



Smart Diagnosis



Filter Management

Integrated Home Appliances Control

Monitor and control your LG appliances from one place.



Straight-forward management

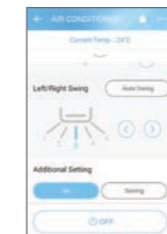

Reservation



Energy Monitoring



Smart Diagnosis

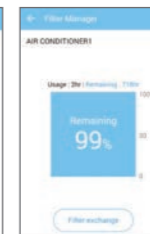

Filter Management

Access your air conditioner anytime and from anywhere

with a Wi-Fi equipped device and LG's exclusive control app, LG ThinQ.



Smart Diagnosis

Smart Diagnosis allows you to monitor the health of your air conditioner directly from your smartphone.

- ※ Specifications may vary for each model.
- ※ When connected to Multi ODU, Smart Diagnosis function may not be supported.

What is Smart Diagnosis?

Smart Diagnosis allows users to conveniently check setup, installation, troubleshooting and other information directly from a smartphone.

- ※ Builds upon widespread smartphone use and offers greater USP diversification
- ※ Perfect for consumers who are unable to view information about their air conditioner via a display or remote control.

How it Works

Embedded Wi-Fi Model

By using "LG ThinQ" App and clicking "Start Smart Diagnosis", monitor and check diagnosis results conveniently via Wi-Fi.

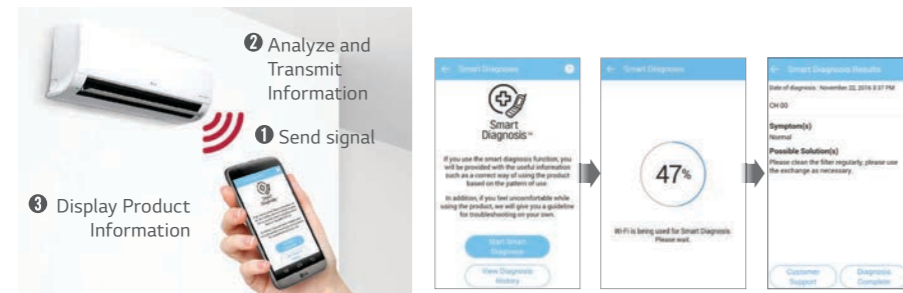

Non Embedded Wi-Fi Model



Benefit

Easily comprehensible error messages make detecting a solution and contacting the service center simple and convenient.

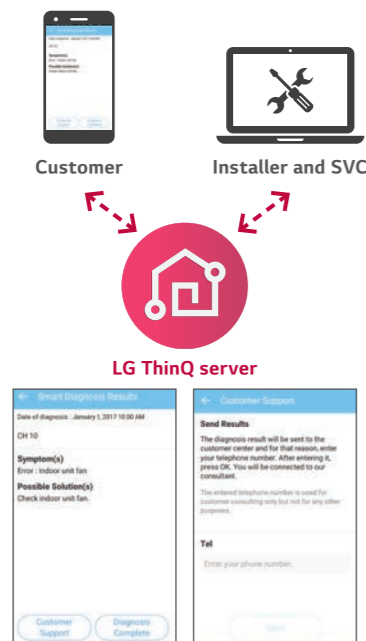

For Consumer



- Easily check operational status of a product without a display or one that provides limited information.
- Save energy by monitoring key operational information and power consumption.
- Using the Maintenance Guide helps to improve device performance and increase product life-span.

For Installer and SVC

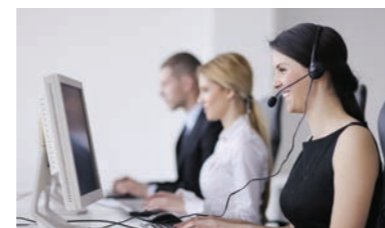

- Understand the product better by easily confirming operational status and information.
- Intuitively diagnose problems by comparing current and past usage data.
- Maintain installation capabilities and reduce installation errors by quickly confirming device operational status.

SIMs

By connecting SIMs chip, you can check the status of your air conditioner and diagnose problems from your smartphone.

- ※ Specifications may vary for each model. ※ When connected to Multi ODU, SIMs function may not be supported.

What is the LG SIMs?

Monitor the status of your air conditioner and accurately diagnose problems by connecting it to a smartphone via a SIMs* chip.



* SIMs : Smart Inverter Monitoring System

Benefit

Easy Monitoring

Diagnose problems anytime, anywhere with a SIMs chip.

How It Works



SIMs App

1. Use a SIMs chip to connect a smartphone to an air conditioner.
2. Monitor and diagnose problems in real time using the SIMs app.

Main

- Current outdoor temperature
- Indoor temperature
- Inverter compressor frequency
- Operating opening
- Error code
- Frequency limits Indoor.
- Outdoor fan speed

Indoor Unit

- Indoor Unit capacity
- Operation mode
- THM mode
- REM mode
- FAN operating condition
- EEV opening
- Room temperature
- Suction Temperature
- Intermediate temperature
- Exit temperature

Outdoor Unit

- Frequency
- Fan RPM
- DC Link
- Input current
- Input voltage
- EEV operation mode
- Restart timer
- Compressor mode
- EEV opening

Chart

- Room temperature
- Heat exchanger pipe temperature
- Compressor discharge temperature
- Frequency
- Outdoor temperature
- Compressor suction temperature
- Electric current
- Voltage

Certificate



※ Smartphone Requirements (iOS : 6.1 or later, Android : 2.3 or later)

Low Refrigerant Detection

Early notification of low refrigerant protects your air conditioner from the risk of damage.

※ Specifications may vary for each model. ※ Depending on the experimental conditions.
 ※ When connected to Multi ODU, Low Refrigerant Detection function may not be supported.

How It Works

Early Detection of Low Refrigerant Levels

The Air Conditioner is automatically shut down when low refrigerant level is detected.

3 Checkpoints for Low Refrigerant Level :

- 1) The heat exchanger temperature is comparatively cool
- 2) The outdoor unit is working properly
- 3) The energy consumption is working under a standard pattern

If any of the above conditions are not met, for a maximum of 4 times, after 15 minutes of Air Conditioner operation, a low refrigerant level is detected and the Air Conditioner is shut down.

Capacity and Effectiveness of the Refrigerant Levels

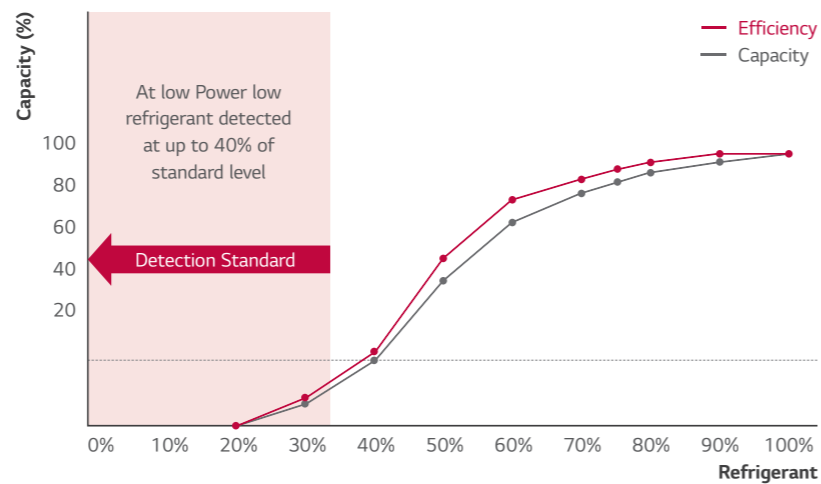

※ This function only works under the following conditions
 - Indoor/Outdoor temperature is up to 20 degrees Celsius
 - Cooling and dehumidification mode

Benefit

Longer Lifespan for Air Conditioner



When low refrigerant Level is detected, it alternately shows CH and 36 on the display.

※ Some models show CH and 38 alternately on the display.

Supreme Energy Efficiency

LG's revolutionary Inverter technology boasts powerful yet quiet performance while minimizing energy consumption. With world-class energy efficiency, enjoy comfort as well as energy savings.

※ Based on F09MT Model. ※ Specifications may vary for each model.

High Efficient Compressor and Reversing Valve

Rotary Compressor and Motor Efficiency

The number of suction connections has been reduced from two to one to increase the efficiency of the refrigerant compression during low speed conditions. The DC motor in LG air conditioners remains unsurpassable incomparable to in the world's top class efficiencies.

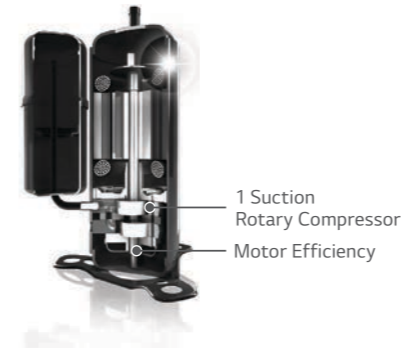

Bi-Stable Reversing Valve

The Input power of 4 way valve has been reduced to 0W by using a Bi-Stable type.

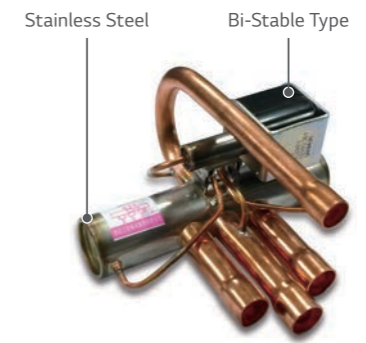

Improved Inverter Drive Efficiency

Used to optimize the time of current flow by controlling the number of converter switching according to energy consumption status. Displays comparatively higher performance and advanced energy efficiency than conventional Inverter air conditioner by reducing power loss with an advanced material component called SiC.



Energy Display

LG's Energy Display panel monitors the amount of energy levels used. Reduce energy consumption while enjoying a comfortable indoor environment by checking your energy level directly on the AC panel.

※ Specifications may vary for each model. ※ When connected to Multi ODU, Energy Display function may not be supported.

How it Works

Magic Display & Remote Control

With the push of a button on the remote control, indoor unit's LCD display shows the current and total energy use, thus making the users aware of reducing energy consumption.



Benefit

Normal Mode

Current Setting Temp.

Electric Power

Displays Current Energy Use



Active Energy Control 4 - Step

LG's Active Energy Control adjusts the energy consumption level and cooling capacity by controlling maximum frequency of the compressor motor.

※ Specifications may vary for each model. ※ Depending on the experimental conditions.
 ※ When connected to Multi ODU, Active Energy Control function may not be supported. ※ Active Energy Control works only cooling mode.

Concept & Benefit

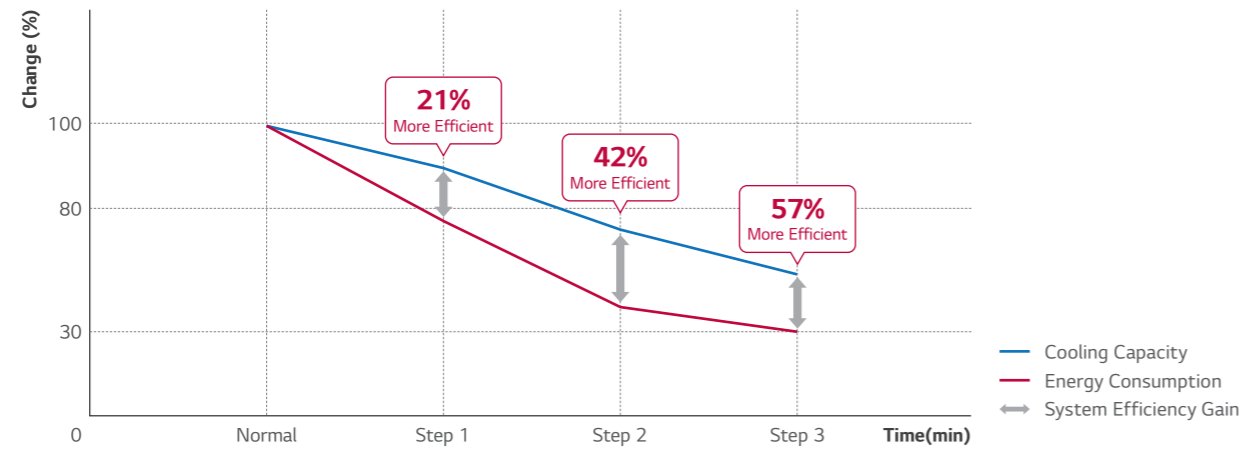

※ Test Conditions : Normal Temperature (Indoor Temperature at the Cooling Mode : 28°C, Outdoor Temperature : 32°C)
 ※ Test Model : DC12RH

How It Works

NORMAL 100% energy usage

Many people and high-activity level.



STEP 1 80% energy usage

Few people and moderate-activity levels.



STEP 2 60% energy usage

Fewer people and low-activity levels.



STEP 3 40% energy usage

Fewest people with no activity.



Comfort Air (Indirect Air)

LG provides pure hygienic and temperature regulated atmosphere surrounding your living space. An automatic vane angle adjustment sets perfect vane angle and air volume.

※ Specifications may vary for each model.

Concept

Comfort Air changes the air flow angle to ensure that air is directed away from occupants to promote more comfortable environments optimized for sleeping and more.

How It Works

Control Panel



Comfort Vane

This option conveniently sets an AC's louvers to a preset position so that outflowing air is directed away from a room's occupants.



Scene 1: Inclines to a maximum 80° angle.
 Sets vane angle to highest position :
 Optimized for gentle airflow cooling.

Indoor Unit Display



Remote Controller Display



Scene 2: Declines to a maximum 10° angle.
 Sets vane angle to lowest position :
 Optimized for gentle airflow heating.

Indoor Unit Display



Remote Controller Display



4 Way Swing

Cool air reaches out to the entire room regardless of where the air conditioner is installed.

※ Specifications may vary for each model.

How It Works

6-Step Vane, Control up to 70°

The vertical vane, which moves up and down, has 6 different settings including full-auto swing.



5-Step Louver, Control up to 110°

The louver, which sways left and right, has 5 different settings including full auto-swing.

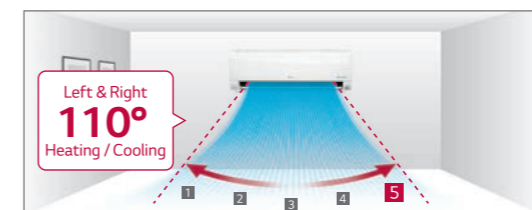

※ Angle can be different from each model and working mode.

Easy and Simple Control

Airflow direction can be changed by LG ThinQ Wi-Fi app.

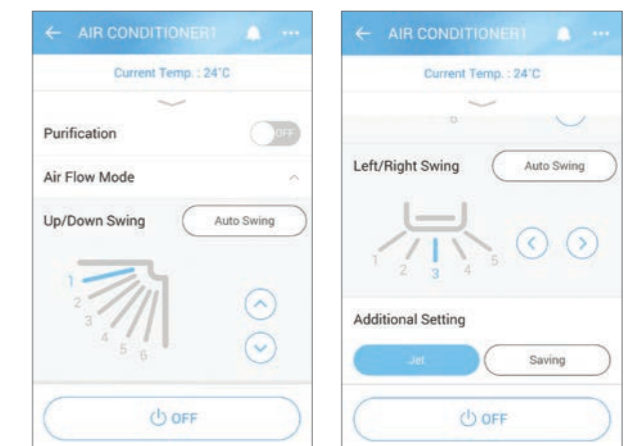

Up/Down Swing

Left/Right Swing

Low Noise

LG Air conditioners operate at 19dB low noise level.

※ Specifications may vary for each model.

How It Works

LG's Unique Skew Fan

By minimizing the surface pressure of the fan blade when in contact with the air, the noise produced by the air conditioning unit is reduced to a remarkably low level.



ALVC (Active Low Vibration Control)

A speed-error component estimates the load to compensate for imbalances, which are the primary causes of vibration and noise, enabling the rotation of the motor without vibration at low Hz levels.

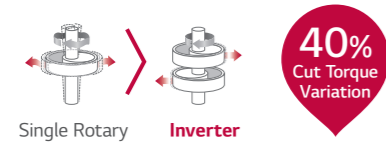

BLDC Fan Motor

With strong torque and powerful ND magnetism as well as precise speed control of 13 different steps for smooth operation, the BLDC motor provides substantial air volume and high static pressure, while keeping electrical and mechanical noise lower, and making high-speed operation available.

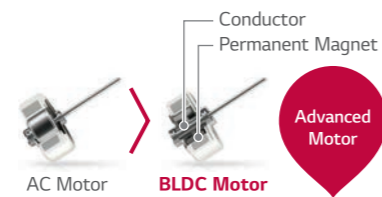

AC Motor

- Low efficiency.
- Heat problem during overhauling.
- Difficult precise speed control.

BLDC Motor

- Low electric and mechanical noise.
- Precise speed control durable.

Benefit

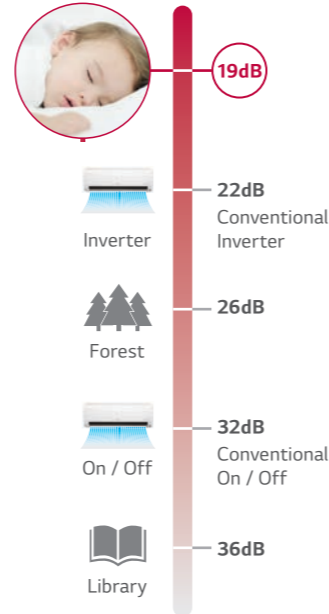

Silent Mode

Silent mode ensures a tranquil and serene experience for the user by reducing noise disturbances while you are resting.

※ Specifications may vary for each model.

※ Depending on the experimental conditions.

※ When connected to Multi Outdoor unit, Silent Mode is working by simply setting the dip switch on the PCB of the outdoor unit.

How It Works

In Silent Mode, the overall sound level of the outdoor unit drops by up to 3dB and the sound level of the indoor unit also decreases.

Press the Silent Button

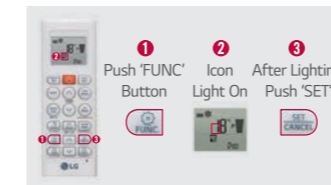

Controls the Outdoor Compressor



Test Result

Noise Comparison Graph

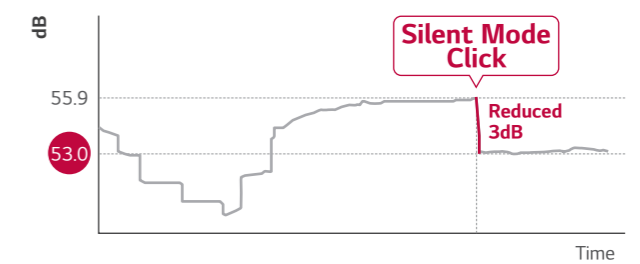

※ Test Conditions

Spec : Selecting Silent Mode reduces the noise of an outdoor fan unit by 3dB.
Assessment : 36.2 dB emitted from center/side of unit at a distance of 1m.

10-Year Inverter Compressor Warranty

With confidence in product quality and a desire to enhance the lives of customers, LG provides a 10-year warranty on the Residential Air Conditioners' Inverter Compressor.

※ Specifications may vary for each model.

What is the 10 Year Warranty?

With the 10-year warranty on the compressor, users can be assured of the functionality of our product for a longer period of time.

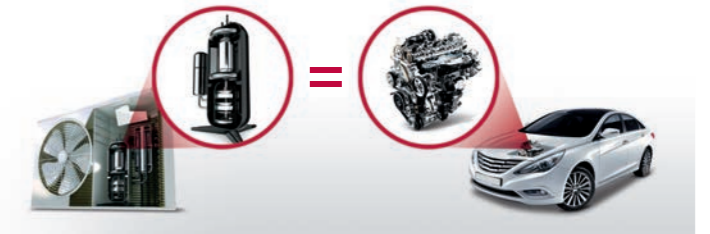

Benefit & Verification

Reliable Air Conditioner

Product safety is emphasized by offering a 10-year warranty on the compressor to reassure customers about product durability.

Verification

TUV Rheinland, Long Term Accelerated-reliability Test & High Marginal Test



Single Rotary Type Twin Rotary Type

※ Long Term Accelerated-Reliability test

LG's unique testing method with reinforced operating condition for a product life assurance to test and determine the product life cycle in a short period of time by accelerating the life cycle.

※ High Marginal Test

Test method to secure durability in various adverse conditions that may occur in the field by performing comp reliability test against higher pressure and temperature than the designed range of pressure and temperature which the comp operates in.

※ Verification obtained from TUV Rheinland for 10-year product life cycle.

**DUAL
INVERTER
COMPRESSOR** | **10
YEAR
WARRANTY**

Quick & Easy Installation

LG air conditioner is designed for an easy and efficient installation, making it possible to install several units in a short period of time.

※ Specifications may vary for each model.

Concept

By reducing the manpower and time required for installation, it is now possible to install more units in less time.

How It Works

One Simple Packing Box

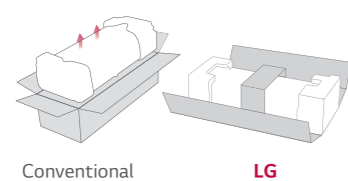

Wider Tubing Space

The space provided for tubing facilitates the whole installation process and hides the unorganized parts, making it appear clean and tidy.



Installation Plate Improvement

LG's installation plate is larger and customized to reduce installation time.

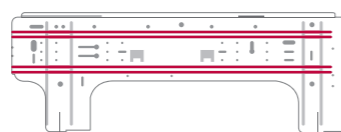

Detachable Bottom Cover

The air conditioner's bottom cover is detachable for easier installation and access.

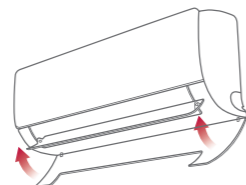

Installation Support Clip

A support clip creates adequate space between the wall and the unit for easier installation.

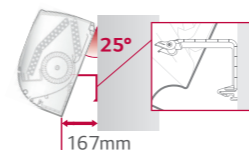

Quick button for running test

The test button is conveniently located and easy to find.

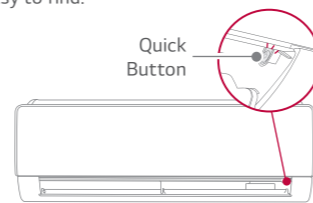

Gold Fin™

The Gold Fin™ coating protects the surface of the heat exchanger from unnecessary wear and corrosion.

※ Specifications may vary for each model. ※ Depending on the experimental conditions.

How It Works

Corrosion-resistant protective layer

The gold-colored special coating on the fin of the heat exchanger prevents corrosion, extending the life of the unit.

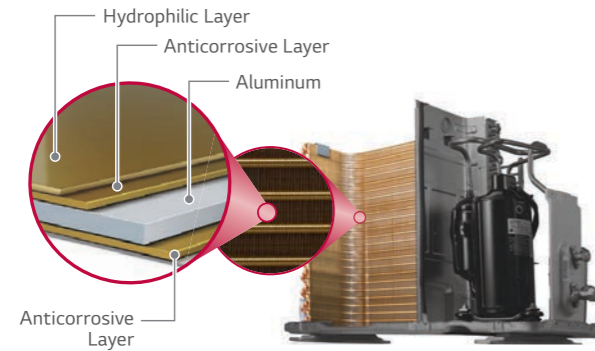

Test Result

Conventional Fin



Gold Fin™



* Test result 360 hrs. after being exposed to sodium chloride.

Fast Cooling

The cool airflow reaches all the corners of the room, keeping the space cool and comfortable.

※ Specifications may vary for each model. ※ Depending on the experimental conditions.

Pain Point

Bigger Skew Fan

A 25% larger skew fan emanates highly powerful blasts of air.

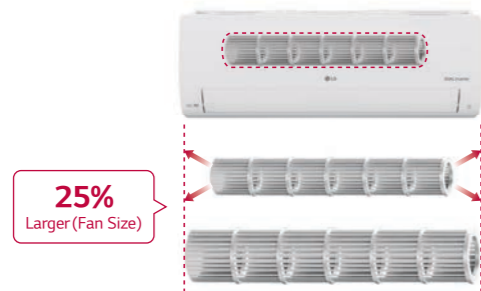

Cooling Outlet

A larger, optimally designed cooling outlet emanates to large areas and cools spaces faster.

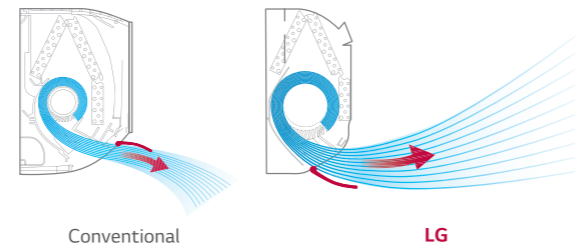

Test Result

Test Result

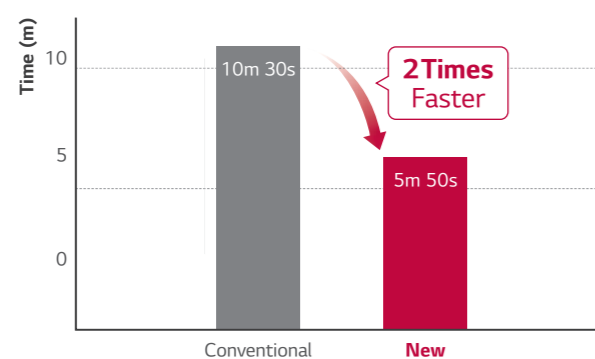

※ Test Conditions :
Indoor temperature 33°C, Outdoor temperature 35°C,
Relative humidity 60%, Setting temperature 26°C
Test room size : 4.3 m * 7.0 m * 2.3 m

Changes in Temperature Over 30 Minutes

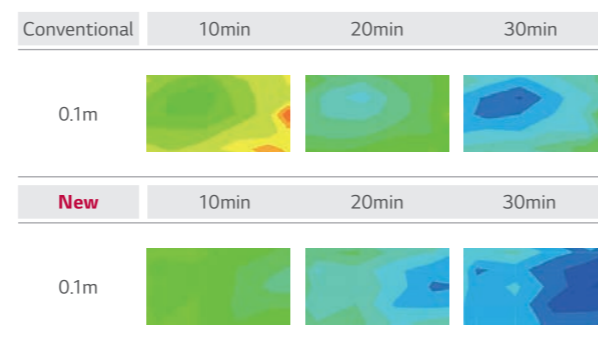

※ Test Conditions :
Outdoor temperature : 35°C, Indoor temperature : 33°C,
Humidity : 60%, Remote control : 26°C High
Test room size : 4.3 m * 7.0 m * 2.3 m

Jet Cool

The cool airflow reaches all the corners of the room, keeping the space cool and comfortable.

※ Specifications may vary for each model. ※ Depending on the experimental conditions.

How It Works

One Click "Jet Mode"

Reduces the temperature of outflowing air to 18°C for 30 minutes with just one click.



More Powerful Performance

By reducing the second vortex, which decreases airflow within the air outlet, and enlarging the fan size, the amount of airflow is increased to 13.0 CMM.

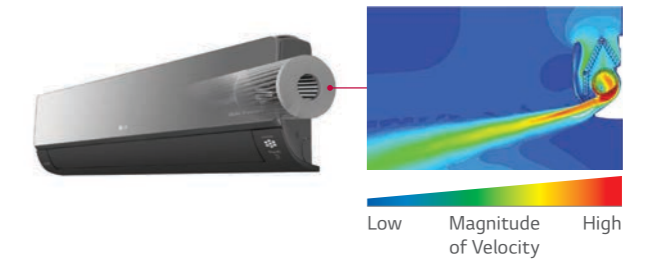

Fast Heating

LG Residential Air Conditioners satisfy your heating needs while consuming less energy, by heating a wider space in a shorter period of time to create a warm and comfortable living environment.

※ Specifications may vary for each model. ※ Depending on the experimental conditions.

How It Works

4 Way Auto Swing (Easy Airflow Control)

4 Way Auto Swing adjusts airflow based on the surrounding environment, allowing for optimal distribution of warm air to living areas and enabling quick heating.

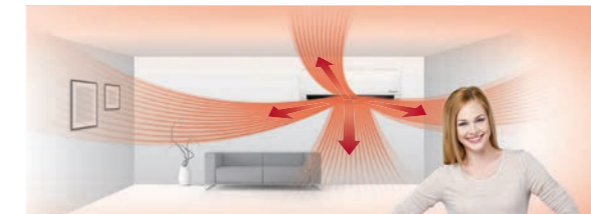

Benefit & Test Result

22% Quick Heating

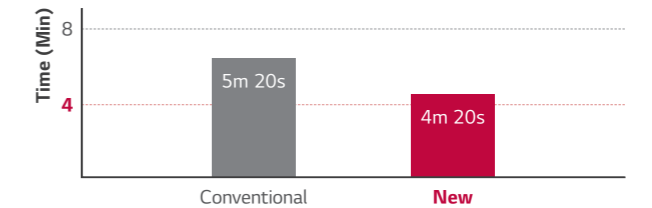

※ Test Conditions :
Outdoor temperature : 7°C, Indoor temperature : 12°C,
Humidity : 87%, Remote control : 30°C Power

Changes in Temperature Over 20 Minutes

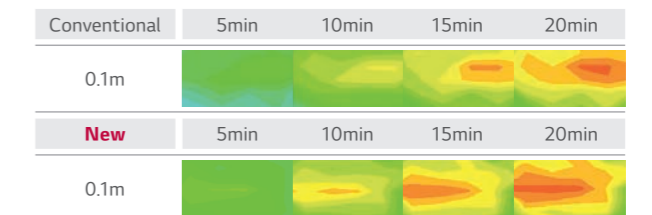

※ Test Conditions :
Outdoor temperature : 7°C, Indoor temperature : 12°C,
Humidity : 87%, Remote control : 30°C Power

Vertical Airflow

When heating, the vane sends heated air downwards to maintain a pleasant and balanced room temperature.

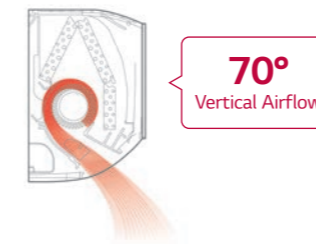



LG participates in the ECP programme for EUROVENT VRF program. Check ongoing validity of certification : www.eurovent-certification.com

Single Combination

UNIT				9K	12K
INDOOR				A09FT NSF	A12FT NSF
Capacity	Cooling	Min. / Rated / Max.	kW	0.89 / 2.50 / 3.70	0.89 / 3.50 / 4.04
	Heating	Min. / Rated / Max.	kW	0.89 / 3.30 / 4.10	0.89 / 4.00 / 5.10
Power Input	Heating -7°C	Rated	kW	3.20	3.50
	Cooling / Heating	Rated	W	658 / 831	1,050 / 1,108
EER			W/W	3.80	3.33
S.E.E.R.				6.80	6.60
P design C			kW	2.50	3.50
COP			W/W	3.97	3.61
S.C.O.P		(Average / Warmer)		4.00 / 4.60	4.00 / 4.60
P design H (Average / Warmer)			kW	2.70 / 1.50	2.70 / 1.50
Energy Label (A+++ to D Scale)	Cooling		A++	A++	A++
Annual Energy Consumption	Heating	(Average / Warmer)	kWh	129	186
	Cooling	(Average / Warmer)	kWh	945 / 457	945 / 457
Sound Pressure	Cooling	S / L / M / H	dB(A)	27 / 35 / 39 / 45	27 / 35 / 39 / 45
	Heating	L / M / H	dB(A)	35 / 39 / 45	35 / 39 / 45
Sound Power	Cooling		dB(A)	60	60
Air Flow Rate	Cooling	S / L / M / H / Max. (Power)	m³/min	6.0 / 7.6 / 9.0 / 10.0	6.0 / 7.6 / 9.0 / 10.0
	Heating	L / M / H	m³/min	6.1 / 7.8 / 9.3	6.1 / 7.8 / 9.3
Dehumidification Rate			l/h	1.1	1.3
Running Current	Cooling	Min. / Rated / Max.	A	1.10 / 3.20 / 6.00	1.10 / 4.90 / 6.00
	Heating	Min. / Rated / Max.	A	1.10 / 4.10 / 7.00	1.10 / 5.10 / 7.00
Starting Current	Cooling / Heating	Rated	A	3.20 / 4.10	4.90 / 5.10
Power Supply			Ø / V / Hz	1 / 220-240 / 50	1 / 220-240 / 50
Circuit Breaker			A	15	15
Power Supply Cable			N x mm²	3 x 1.0	3 x 1.0
Power & Transmission Cable			N x mm²	4 x 1.0 (Including Earth)	4 x 1.0 (Including Earth)
Dimension			mm	600 x 600 x 146	600 x 600 x 146
Net Weight			kg	14.4	14.4
Fan Motor Output			W	16.7	16.7
OUTDOOR				A09FT UL2	A12FT UL2
Operation Range	Cooling	Min. / Max.	°C DB	-15 / 48	-15 / 48
	Heating	Min. / Max.	°C DB	-10 / 24	-10 / 24
Sound Pressure	Cooling / Heating	High	dB(A)	51 / 51	51 / 51
Sound Power	Cooling	High	dB(A)	65	65
Air Flow Rate		High	m³/min	35	35
Piping	Liquid (ODU / IDU)	Min. / Max.	m	3 / 20	3 / 20
	Elevation (ODU / IDU)	Min. / Max.	m	10	10
Piping Connection	Liquid	OD (Outside)	mm (inch)	6.35 (1/4)	6.35 (1/4)
	Gas	OD (Outside)	mm (inch)	9.52 (3/8)	9.52 (3/8)
Drain Hose Size		OD (Outside)	mm (inch)	21.5 (27/32)	21.5 (27/32)
Refrigerant	Type			R32	R32
	Charge at 7.5m		kg	0.800	0.800
	Additional Charge		t-CO ₂ eq	0.540	0.540
	GWP		g/m	20	20
Fan Motor Output			W	675	675
Compressor Type				Inverter Twin Rotary	Inverter Twin Rotary
Net Weight			kg	43	43
Dimension			mm	34.4	34.4
			mm	770 x 545 x 288	770 x 545 x 288
ACCESSORIES & OTHERS					
Multi Compatible				-	-
PI 485				Y	Y
Dry Contact				Y	Y
Wired Remote Controller				-	-

※ This product contains Fluorinated greenhouse gases (R32).
 ※ S : Sleep / L : Low / M : Medium / H : High
 ※ GWP : Global warming potential
 ※ t-CO₂eq : F-gas(kg)*GWP/1000
 ※ Specification, design and feature are subject to change without prior notice.

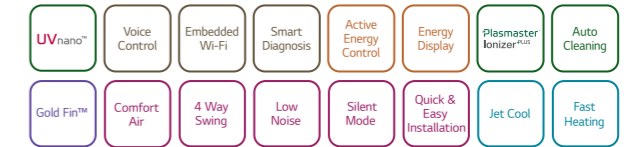

LG participates in the ECP programme for EUROVENT VRF program. Check ongoing validity of certification : www.eurovent-certification.com

Single Combination

UNIT				9K	12K	18K	24K
INDOOR				AC09BH NSJ	AC12BH NSJ	AC18BH NSK	AC24BH NSK
Capacity	Cooling	Min. / Rated / Max.	kW	0.89 / 2.50 / 3.70	0.89 / 3.50 / 4.04	0.90 / 5.00 / 5.50	0.90 / 6.60 / 7.42
	Heating	Min. / Rated / Max.	kW	0.89 / 3.30 / 4.10	0.89 / 4.00 / 5.10	0.90 / 5.80 / 6.40	0.90 / 7.50 / 8.64
Power Input	Heating -7°C	Rated	kW	2.60	3.00	4.20	6.00
	Cooling / Heating	Rated	W	656 / 800	1,080 / 1,050	1,562 / 1,611	2,164 / 2,238
EER			W/W	3.81	3.24	3.20	3.25
S.E.E.R.				7.00	6.60	7.00	6.90
P design C			kW	2.50	3.50	5.00	6.60
COP			W/W	4.13	3.81	3.60	3.35
S.C.O.P		(Average / Warmer)		4.00 / 4.90	4.00 / 4.90	4.30 / 5.30	4.30 / 5.30
P design H (Average / Warmer)			kW	2.50 / 1.30	2.50 / 1.30	3.90 / 2.10	5.00 / 2.70
Energy Label (A+++ to D Scale)	Cooling		A++	A++	A++	A++	A++
Annual Energy Consumption	Heating	(Average / Warmer)	kWh	A+ / A++	A+ / A++	A+ / A+++	A+ / A+++
	Cooling	(Average / Warmer)	kWh	125	186	250	335
Sound Pressure	Heating	(Average / Warmer)	kWh	875 / 371	875 / 371	1,270 / 555	1,628 / 713
	Cooling	S / L / M / H	dB(A)	19 / 27 / 35 / 41	19 / 27 / 35 / 41	31 / 34 / 39 / 44	31 / 34 / 42 / 47
Sound Power	Heating	L / M / H	dB(A)	27 / 35 / 41	27 / 35 / 41	34 / 39 / 44	34 / 42 / 47
	Cooling		dB(A)	59	59	60	65
Air Flow Rate	Cooling	S / L / M / H / Max. (Power)	m³/min	3.0 / 4.2 / 7.5 / 10.0 / 12.5	3.0 / 4.2 / 7.5 / 10.0 / 12.5	8.0 / 10.5 / 13.0 / 14.5 / 15.5	8.0 / 10.5 / 13.1 / 16.1 / 18.3
	Heating	L / M / H	m³/min	5.6 / 7.2 / 10.0	5.6 / 7.2 / 10.0	11.0 / 13.5 / 16.0	11.0 / 14.3 / 17.6
Dehumidification Rate			l/h	1.1	1.3	1.8	2.5
Running Current	Cooling	Min. / Rated / Max.	A	1.10 / 3.30 / 6.00	1.10 / 4.70 / 6.00	1.20 / 6.90 / 9.00	1.20 / 9.80 / 14.00
	Heating	Min. / Rated / Max.	A	1.10 / 4.00 / 7.00	1.10 / 4.70 / 7.00	1.20 / 7.10 / 9.50	1.20 / 10.00 / 14.00
Starting Current	Cooling / Heating	Rated	A	3.30 / 4.00	4.70 / 4.70	6.90 / 7.10	9.80 / 10.00
Power Supply			Ø / V / Hz	1 / 220-240 / 50	1 / 220-240 / 50	1 / 220-240 / 50	1 / 220-240 / 50
Circuit Breaker			A	15	15	20	25
Power Supply Cable			N x mm²	3 x 1.0	3 x 1.0	3 x 1.5	3 x 2.5
Power & Transmission Cable			N x mm²	4 x 1.0 (Including Earth)	4 x 1.0 (Including Earth)	4 x 1.0 (Including Earth)	4 x 1.0 (Including Earth)
Dimension			mm	837 x 308 x 192	837 x 308 x 192	998 x 345 x 212	998 x 345 x 212
Net Weight			kg	9.9	9.9	12.8	13.5
Fan Motor Output			W	30	30	30	58
OUTDOOR				AC09BH UA3	AC12BH UA3	AC18BH UL2	AC24BH U24
Operation Range	Cooling	Min. / Max.	°C DB	-10 / 48	-10 / 48	-15 / 48	-15 / 48
	Heating	Min. / Max.	°C DB	-10 / 24	-10 / 24	-10 / 24	-10 / 24
Sound Pressure	Cooling / Heating	High	dB(A)	48 / 50	48 / 50	53 / 55	54 / 57
Sound Power	Cooling	High	dB(A)	65	65	65	70
Air Flow Rate		High	m³/min	27	27	35	49
Piping	Liquid (ODU / IDU)	Min. / Max.	m	3 / 15	3 / 15	3 / 20	3 / 30
	Elevation (ODU / IDU)	Min. / Max.	m	7	7	10	15
Piping Connection	Liquid	OD (Outside)	mm (inch)	6.35 (1/4)	6.35 (1/4)	6.35 (1/4)	6.35 (1/4)
	Gas	OD (Outside)	mm (inch)	9.52 (3/8)	9.52 (3/8)	12.7 (1/2)	15.88 (5/8)
Drain Hose Size		OD (Outside)	mm (inch)	21.5 (27/32)	21.5 (27/32)	21.5 (27/32)	21.5 (27/32)
Refrigerant	Type			R32	R32	R32	R32
	Charge at 7.5m		kg	0.700	0.700	1.000	1.100
	Additional Charge		t-CO ₂ eq	0.473	0.473	0.675	0.743
	GWP		g/m	20	20	20	20
Fan Motor Output			W	675	675	675	675
Compressor Type				Inverter Twin Rotary	Inverter Twin Rotary	Inverter Twin Rotary	Inverter Twin Rotary
Net Weight			kg	43	43	43	85
Dimension			mm	26.0	26.0	35.2	46.4
			mm	717 X 495 X 230	717 X 495 X 230	770 X 545 X 288	870 X 650 X 330
ACCESSORIES & OTHERS							
Multi Compatible				Y	Y	Y	Y
PI 485				-	-	-	-
Dry Contact				Y	Y	Y	Y
Wired Remote Controller				Y	Y	Y	Y

※ This product contains Fluorinated greenhouse gases (R32).
 ※ S : Sleep / L : Low / M : Medium / H : High
 ※ GWP : Global warming potential
 ※ t-CO₂eq : F-gas(kg)*GWP/1000
 ※ Specification, design and feature are subject to change without prior notice.

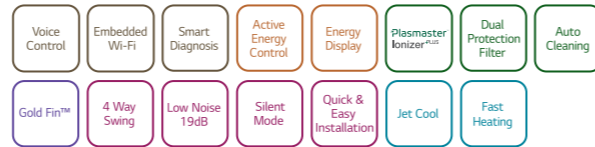

LG participates in the ECP programme for EUROVENT VRF program. Check ongoing validity of certification : www.eurovent-certification.com

Single Combination

UNIT				9K	12K
INDOOR				F09MT NSM	F12MT NSM
Capacity	Cooling	Min. / Rated / Max.	kW	0.90 / 2.50 / 4.00	0.90 / 3.50 / 4.25
	Heating	Min. / Rated / Max.	kW	0.90 / 3.20 / 6.90	0.90 / 4.00 / 7.32
	Heating -7°C	Rated	kW	4.30	4.70
Power Input	Cooling / Heating	Rated	W	490 / 593	833 / 785
EER			W/W	5.10	4.20
S.E.E.R.				9.40	9.10
P design C			kW	2.50	3.50
COP			W/W	5.40	5.10
S.C.O.P		(Average / Warmer)		5.10 / 6.60	5.10 / 6.60
P design H (Average / Warmer)			kW	3.70 / 2.05	3.80 / 2.05
Energy Label (A+++ to D Scale)	Cooling			A+++	A+++
	Heating	(Average / Warmer)		A+++ / A+++	A+++ / A+++
Annual Energy Consumption	Cooling		kWh	93	135
	Heating	(Average / Warmer)	kWh	1,016 / -	1,043 / -
Sound Pressure	Cooling	S / L / M / H	dB(A)	19 / 27 / 35 / 40	19/27/35/40
	Heating	L / M / H	dB(A)	27 / 35/ 40	27 / 35/ 40
Sound Power	Cooling		dB(A)	60	60
Air Flow Rate	Cooling	S / L / M / H / Max. (Power)	m³/min	6.6 / 8.7 / 11.1 / 12.4 / 15.5	6.6 / 8.7 / 11.1 / 12.4 / 15.5
	Heating	L / M / H	m³/min	8.7 / 11.1 / 14.3	8.7 / 11.1 / 14.3
Dehumidification Rate			l/h	1.7	1.7
Running Current	Cooling	Min. / Rated / Max.	A	1.00 / 3.80 / 8.10	1.00 / 6.10 / 8.10
	Heating	Min. / Rated / Max.	A	1.00 / 4.60 / 8.80	1.00 / 5.80 / 8.80
Starting Current	Cooling / Heating	Rated	A	3.80 / 4.60	6.10 / 5.80
Power Supply			Ø / V / Hz	1 / 220-240 / 50	1 / 220-240 / 50
Circuit Breaker			A	15	15
Power Supply Cable			N x mm²	3 x 1.0	3 x 1.0
Power & Transmission Cable			N x mm²	4 x 1.0 (Including Earth)	4 x 1.0 (Including Earth)
Dimension			mm	857 x 295 x 235	857 x 295 x 235
Net Weight			kg	11.0	11.0
Fan Motor Output			W	30	30
OUTDOOR				F09MT U24	F12MT U24
Operation Range	Cooling	Min. / Max.	°C DB	-10 / 48	-10 / 48
	Heating	Min. / Max.	°C DB	-25 / 24	-25 / 24
Sound Pressure	Cooling / Heating	High	dB(A)	48 / 50	48 / 50
Sound Power	Cooling	High	dB(A)	65	65
Air Flow Rate		High	m³/min	49	49
Piping	Liquid (ODU / IDU)	Min. / Max.	m	3 / 20	3 / 20
	Elevation (ODU / IDU)	Min. / Max.	m	10	10
Piping Connection	Liquid	OD (Outside)	mm (inch)	6.35 (1/4)	6.35 (1/4)
	Gas	OD (Outside)	mm (inch)	9.52 (3/8)	9.52 (3/8)
Drain Hose Size		OD (Outside)	mm (inch)	21.5 (27/32)	21.5 (27/32)
Refrigerant	Type			R32	R32
	Charge at 7.5m		kg	1.000	1.000
	Additional Charge		t-CO ₂ eq	0.675	0.675
	GWP		g/m	20	20
Fan Motor Output			W	675	675
Compressor Type				85	85
Compressor Type				Inverter Twin Rotary	Inverter Twin Rotary
Net Weight			kg	43.0	43.0
Dimension			mm	870 x 650 x 330	870 x 650 x 330
ACCESSORIES & OTHERS					
Multi Compatible				Y	Y
PI 485				-	-
Dry Contact				Y	Y
Wired Remote Controller				Y	Y

※ This product contains Fluorinated greenhouse gases (R32).
 ※ S : Sleep / L : Low / M : Medium / H : High
 ※ GWP : Global warming potential
 ※ t-CO₂eq : F-gas(kg)*GWP/1000
 ※ Specification, design and feature are subject to change without prior notice.

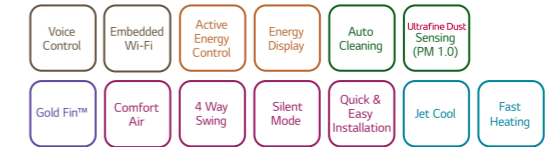

LG participates in the ECP programme for EUROVENT VRF program. Check ongoing validity of certification : www.eurovent-certification.com

Single Combination

UNIT				9K	12K
INDOOR				AP09RT NSJ	AP12RT NSJ
Capacity	Cooling	Min. / Rated / Max.	kW	0.89 / 2.50 / 3.70	0.89 / 3.50 / 4.00
	Heating	Min. / Rated / Max.	kW	0.89 / 3.30 / 4.10	0.89 / 4.00 / 4.70
	Heating -7°C	Rated	kW	2.60	3.00
Power Input	Cooling / Heating	Rated	W	710 / 850	1,160 / 1,130
EER			W/W	3.52	3.02
S.E.E.R.				6.60	6.20
P design C			kW	2.50	3.50
COP			W/W	3.88	3.54
S.C.O.P		(Average / Warmer)		4.0 / 5.0	4.0 / 5.0
P design H (Average / Warmer)			kW	2.5 / 1.4	2.5 / 1.4
Energy Label (A+++ to D Scale)	Cooling			A++	A++
	Heating	(Average / Warmer)		A+ / A++	A+ / A++
Annual Energy Consumption	Cooling		kWh	133	198
	Heating	(Average / Warmer)	kWh	875 / 393	875 / 393
Sound Pressure	Cooling	S / L / M / H	dB(A)	21 / 27 / 35 / 42	21 / 27 / 35 / 42
	Heating	L / M / H	dB(A)	30 / 35 / 41	30 / 35 / 41
Sound Power	Cooling		dB(A)	59	59
Air Flow Rate	Cooling	S / L / M / H / Max. (Power)	m³/min	3.0 / 4.2 / 6.6 / 10.0 / 11.0	3.0 / 4.2 / 6.6 / 10.0 / 11.0
	Heating	L / M / H	m³/min	4.2 / 6.6 / 10.0	4.2 / 6.6 / 10.0
Dehumidification Rate			l/h	1.10	1.30
Running Current	Cooling	Min. / Rated / Max.	A	1.1 / 3.5 / 6.0	1.1 / 5.2 / 6.2
	Heating	Min. / Rated / Max.	A	1.1 / 4.0 / 7.0	1.1 / 5.1 / 7.0
Starting Current	Cooling / Heating	Rated	A	3.50 / 4.00	5.20 / 5.10
Power Supply			Ø / V / Hz	1 / 220-240 / 50	1 / 220-240 / 50
Circuit Breaker			A	15	15
Power Supply Cable			N x mm²	3 x 1.0	3 x 1.0
Power & Transmission Cable			N x mm²	4 x 1.0 (Including Earth)	4 x 1.0 (Including Earth)
Dimension			mm	857 x 348 x 189	857 x 348 x 189
Net Weight			kg	9.5	9.5
Fan Motor Output			W	30	30
OUTDOOR				AP09RT UA3	AP12RT UA3
Operation Range	Cooling	Min. / Max.	°C DB	-10 / 48	-10 / 48
	Heating	Min. / Max.	°C DB	-10 / 24	-10 / 24
Sound Pressure	Cooling / Heating	High	dB(A)	48 / 50	48 / 50
Sound Power	Cooling	High	dB(A)	65	65
Air Flow Rate		High	m³/min	27	27
Piping	Liquid (ODU / IDU)	Min. / Max.	m	3 / 15	3 / 15
	Elevation (ODU / IDU)	Min. / Max.	m	7	7
Piping Connection	Liquid	OD (Outside)	mm (inch)	6.35 (1/4)	6.35 (1/4)
	Gas	OD (Outside)	mm (inch)	9.52 (3/8)	9.52 (3/8)
Drain Hose Size		OD (Outside)	mm (inch)	21.5 (27/32)	21.5 (27/32)
Refrigerant	Type			R32	R32
	Charge at 7.5m		kg	0.700	0.700
	Additional Charge		t-CO ₂ eq	0.473	0.473
	GWP		g/m	20	20
Fan Motor Output			W	675	675
Compressor Type				43	43
Compressor Type				Inverter Twin Rotary	Inverter Twin Rotary
Net Weight			kg	26	26
Dimension			mm	717 x 495 x 230	717 x 495 x 230
ACCESSORIES & OTHERS					
Multi Compatible				Y	Y
PI 485				-	-
Dry Contact				Y	Y
Wired Remote Controller				Y	Y

※ This product contains Fluorinated greenhouse gases (R32).
 ※ S : Sleep / L : Low / M : Medium / H : High
 ※ GWP : Global warming potential
 ※ t-CO₂eq : F-gas(kg)*GWP/1000
 ※ Specification, design and feature are subject to change without prior notice.

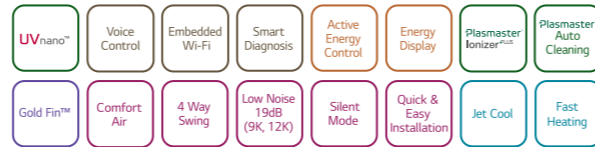

LG participates in the ECP programme for EUROVENT VRF program. Check ongoing validity of certification : www.eurovent-certification.com

Single Combination

UNIT				9K	12K	18K	24K
INDOOR				DC09RH NSJ	DC12RH NSJ	DC18RH NSK	DC24RH NSK
Capacity	Cooling	Min. / Rated / Max.	kW	0.89 / 2.50 / 3.70	0.89 / 3.50 / 4.04	0.90 / 5.00 / 5.50	0.90 / 6.60 / 7.42
	Heating	Min. / Rated / Max.	kW	0.89 / 3.20 / 5.00	0.89 / 4.00 / 6.00	0.90 / 5.80 / 6.40	0.90 / 7.50 / 8.64
	Heating -7°C	Rated	kW	3.20	3.50	4.20	6.00
Power Input	Cooling / Heating	Rated	W	572 / 711	933 / 976	1,562 / 1,611	2,164 / 2,238
EER			W/W	4.37	3.75	3.20	3.05
S.E.E.R.				7.90	7.60	7.00	6.90
P design C			kW	2.50	3.50	5.00	6.60
COP			W/W	4.50	4.10	3.60	3.35
S.C.O.P		(Average / Warmer)		4.60 / 5.40	4.60 / 5.40	4.30 / 5.30	4.30 / 5.30
P design H (Average / Warmer)			kW	2.80 / 1.50	2.90 / 1.50	3.90 / 2.10	5.00 / 2.70
Energy Label (A+++ to D Scale)	Cooling			A++	A++	A++	A++
	Heating	(Average / Warmer)		A++ / A++	A++ / A++	A+ / A+++	A+ / A+++
Annual Energy Consumption	Cooling		kWh	111	161	250	335
	Heating	(Average / Warmer)	kWh	852 / 389	883 / 389	1,270 / 555	1,628 / 713
Sound Pressure	Cooling	S / L / M / H	dB(A)	19 / 27 / 37 / 42	19 / 27 / 37 / 42	31 / 34 / 39 / 44	31 / 34 / 42 / 47
	Heating	L / M / H	dB(A)	27 / 37 / 42	27 / 37 / 42	34 / 39 / 44	34 / 42 / 47
Sound Power	Cooling		dB(A)	60	60	60	65
Air Flow Rate	Cooling	S / L / M / H / Max. (Power)	m ³ /min	3.5 / 5.5 / 9.0 / 11.0 / 13.0	3.5 / 5.5 / 9.0 / 11.0 / 13.0	8.0 / 10.5 / 13.0 / 14.5 / 15.5	8.0 / 10.5 / 13.1 / 16.1 / 18.3
	Heating	L / M / H	m ³ /min	6.5 / 9.0 / 11.0	6.5 / 9.0 / 11.0	11.0 / 13.5 / 16.0	11.0 / 14.3 / 17.6
Dehumidification Rate			l/h	1.1	1.3	1.8	2.5
Running Current	Cooling	Min. / Rated / Max.	A	1.00 / 2.50 / 6.00	1.00 / 4.00 / 6.00	1.20 / 6.90 / 9.00	1.20 / 9.80 / 14.00
	Heating	Min. / Rated / Max.	A	1.00 / 3.20 / 7.00	1.00 / 4.30 / 7.00	1.20 / 7.10 / 9.50	1.20 / 10.40 / 14.00
Starting Current	Cooling / Heating	Rated	A	2.50 / 3.20	4.00 / 4.30	6.90 / 7.10	9.80 / 10.00
Power Supply			Ø / V / Hz	1 / 220-240 / 50	1 / 220-240 / 50	1 / 220-240 / 50	1 / 220-240 / 50
Circuit Breaker			A	15	15	20	25
Power Supply Cable			N x mm ²	3 x 1.0	3 x 1.0	3 x 1.5	3 x 2.5
Power & Transmission Cable			N x mm ²	4 x 1.0 (Including Earth)	4 x 1.0 (Including Earth)	4 x 1.0 (Including Earth)	4 x 1.0 (Including Earth)
Dimension			mm	837 x 308 x 189	837 x 308 x 189	998 x 345 x 210	998 x 345 x 210
Net Weight			kg	9.1	9.1	11.9	12.7
Fan Motor Output			W	30	30	30	58
OUTDOOR				DC09RH UL2	DC12RH UL2	DC18RH UL2	DC24RH U24
Operation Range	Cooling	Min. / Max.	°C DB	-15 / 48	-15 / 48	-15 / 48	-15 / 48
	Heating	Min. / Max.	°C DB	-15 / 24	-15 / 24	-10 / 24	-10 / 24
Sound Pressure	Cooling / Heating	High	dB(A)	49 / 51	49 / 51	53 / 55	54 / 57
Sound Power	Cooling	High	dB(A)	65	65	65	70
Air Flow Rate		High	m ³ /min	35	35	35	49
Piping	Liquid (ODU / IDU)	Min. / Max.	m	3 / 20	3 / 20	3 / 20	3 / 30
	Elevation (ODU / IDU)	Min. / Max.	m	10	10	10	15
Piping Connection	Liquid	OD (Outside)	mm (inch)	6.35 (1/4)	6.35 (1/4)	6.35 (1/4)	6.35 (1/4)
	Gas	OD (Outside)	mm (inch)	9.52 (3/8)	9.52 (3/8)	12.7 (1/2)	15.88 (5/8)
Drain Hose Size		OD (Outside)	mm (inch)	21.5 (27/32)	21.5 (27/32)	21.5 (27/32)	21.5 (27/32)
Refrigerant	Type			R32	R32	R32	R32
	Charge at 7.5m		kg	0.800	0.800	1.000	1.100
	Additional Charge		t-CO ₂ eq	0.540	0.540	0.675	0.743
	GWP		g/m	20	20	20	20
Fan Motor Output			W	675	675	675	675
Compressor Type				Inverter Twin Rotary	Inverter Twin Rotary	Inverter Twin Rotary	Inverter Twin Rotary
Net Weight			kg	34.1	34.1	34.4	46.0
Dimension			mm	770 x 545 x 288	770 x 545 x 288	770 x 545 x 288	870 x 650 x 330
ACCESSORIES & OTHERS							
Multi Compatible				Y	Y	Y	Y
PI 485				Y	Y	Y	Y
Dry Contact				Y	Y	Y	Y
Wired Remote Controller				Y	Y	Y	Y

※ This product contains Fluorinated greenhouse gases (R32).
 ※ S : Sleep / L : Low / M : Medium / H : High
 ※ GWP : Global warming potential
 ※ t-CO₂eq : F-gas(kg)*GWP/1000
 ※ Specification, design and feature are subject to change without prior notice.

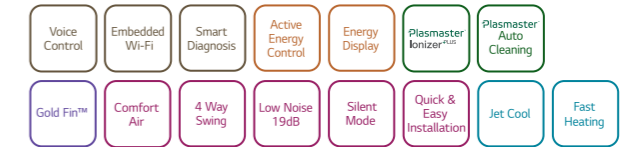

LG participates in the ECP programme for EUROVENT VRF program. Check ongoing validity of certification : www.eurovent-certification.com

Single Combination

UNIT				9K	12K
INDOOR				DC09RT NSJ	DC12RT NSJ
Capacity	Cooling	Min. / Rated / Max.	kW	0.89 / 2.50 / 3.70	0.89 / 3.50 / 4.04
	Heating	Min. / Rated / Max.	kW	0.89 / 3.30 / 4.10	0.89 / 4.00 / 5.10
	Heating -7°C	Rated	kW	2.60	3.00
Power Input	Cooling / Heating	Rated	W	656 / 800	1,080 / 1,050
EER			W/W	3.81	3.24
S.E.E.R.				7.00	6.60
P design C			kW	2.50	3.50
COP			W/W	4.13	3.81
S.C.O.P		(Average / Warmer)		4.00 / 4.90	4.00 / 4.90
P design H (Average / Warmer)			kW	2.50 / 1.30	2.50 / 1.30
Energy Label (A+++ to D Scale)	Cooling			A++	A++
	Heating	(Average / Warmer)		A+ / A++	A+ / A++
Annual Energy Consumption	Cooling		kWh	125	186
	Heating	(Average / Warmer)	kWh	875 / 371	875 / 371
Sound Pressure	Cooling	S / L / M / H	dB(A)	19 / 27 / 35 / 41	19 / 27 / 35 / 41
	Heating	L / M / H	dB(A)	27 / 35 / 41	27 / 35 / 41
Sound Power	Cooling		dB(A)	59	59
Air Flow Rate	Cooling	S / L / M / H / Max. (Power)	m ³ /min	3.0 / 4.2 / 7.5 / 10.0 / 12.5	3.0 / 4.2 / 7.5 / 10.0 / 12.5
	Heating	L / M / H	m ³ /min	5.6 / 7.2 / 10.0	5.6 / 7.2 / 10.0
Dehumidification Rate			l/h	1.1	1.3
Running Current	Cooling	Min. / Rated / Max.	A	1.10 / 3.30 / 6.00	1.10 / 4.70 / 6.00
	Heating	Min. / Rated / Max.	A	1.10 / 4.00 / 7.00	1.10 / 4.70 / 7.00
Starting Current	Cooling / Heating	Rated	A	3.30 / 4.00	4.70 / 4.70
Power Supply			Ø / V / Hz	1 / 220-240 / 50	1 / 220-240 / 50
Circuit Breaker			A	15	15
Power Supply Cable			N x mm ²	3 x 1.0	3 x 1.0
Power & Transmission Cable			N x mm ²	4 x 1.0 (Including Earth)	4 x 1.0 (Including Earth)
Dimension			mm	837 x 308 x 189	837 x 308 x 189
Net Weight			kg	9.1	9.1
Fan Motor Output			W	30	30
OUTDOOR				DC09RT UA3	DC12RT UA3
Operation Range	Cooling	Min. / Max.	°C DB	-10 / 48	-10 / 48
	Heating	Min. / Max.	°C DB	-10 / 24	-10 / 24
Sound Pressure	Cooling / Heating	High	dB(A)	48 / 50	48 / 50
Sound Power	Cooling	High	dB(A)	65	65
Air Flow Rate		High	m ³ /min	27	27
Piping	Liquid (ODU / IDU)	Min. / Max.	m	3 / 15	3 / 15
	Elevation (ODU / IDU)	Min. / Max.	m	7	7
Piping Connection	Liquid	OD (Outside)	mm (inch)	6.35 (1/4)	6.35 (1/4)
	Gas	OD (Outside)	mm (inch)	9.52 (3/8)	9.52 (3/8)
Drain Hose Size		OD (Outside)	mm (inch)	21.5 (27/32)	21.5 (27/32)
Refrigerant	Type			R32	R32
	Charge at 7.5m		kg	0.700	0.700
	Additional Charge		t-CO ₂ eq	0.473	0.473
	GWP		g/m	20	20
Fan Motor Output			W	675	675
Compressor Type				Inverter Twin Rotary	Inverter Twin Rotary
Net Weight			kg	25.1	25.1
Dimension			mm	717 x 495 x 230	717 x 495 x 230
ACCESSORIES & OTHERS					
Multi Compatible				Y	Y
PI 485				Y	Y
Dry Contact				Y	Y
Wired Remote Controller				Y	Y

※ This product contains Fluorinated greenhouse gases (R32).
 ※ S : Sleep / L : Low / M : Medium / H : High
 ※ GWP : Global warming potential
 ※ t-CO₂eq : F-gas(kg)*GWP/1000
 ※ Specification, design and feature are subject to change without prior notice.

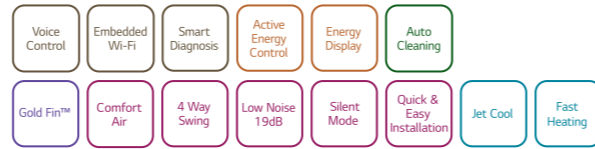

LG participates in the ECP programme for EUROVENT VRF program. Check ongoing validity of certification : www.eurovent-certification.com

Single Combination

UNIT				9K	12K	18K	24K
INDOOR				PC09SQ NSJ	PC12SQ NSJ	PC18SQ NSK	PC24SQ NSK
Capacity	Cooling	Min. / Rated / Max.	kW	0.89 / 2.50 / 3.70	0.89 / 3.50 / 4.04	0.90 / 5.00 / 5.50	0.90 / 6.60 / 7.42
	Heating	Min. / Rated / Max.	kW	0.89 / 3.30 / 4.10	0.89 / 4.00 / 5.10	0.90 / 5.80 / 6.40	0.90 / 7.50 / 8.64
	Heating -7°C	Rated	kW	2.60	3.00	4.20	6.00
Power Input	Cooling / Heating	Rated	W	656 / 800	1,080 / 1,050	1,562 / 1,611	2,164 / 2,238
EER			W/W	3.81	3.24	3.20	3.05
S.E.E.R.				7.00	6.60	7.00	6.90
P design C			kW	2.50	3.50	5.00	6.60
COP			W/W	4.13	3.81	3.60	3.35
S.C.O.P		(Average / Warmer)		4.00 / 4.90	4.00 / 4.90	4.30 / 5.30	4.30 / 5.30
P design H (Average / Warmer)			kW	2.50 / 1.30	2.50 / 1.30	3.90 / 2.10	5.00 / 2.70
Energy Label (A+++ to D Scale)	Cooling			A++	A++	A++	A++
	Heating	(Average / Warmer)		A+ / A++	A+ / A++	A+ / A+++	A+ / A+++
Annual Energy Consumption	Cooling		kWh	125	186	250	335
	Heating	(Average / Warmer)	kWh	875 / 371	875 / 371	1,270 / 555	1,628 / 713
Sound Pressure	Cooling	S / L / M / H	dB(A)	19 / 27 / 35 / 41	19 / 27 / 35 / 41	31 / 34 / 39 / 44	31 / 34 / 42 / 47
	Heating	L / M / H	dB(A)	27 / 35 / 41	27 / 35 / 41	34 / 39 / 44	34 / 42 / 47
Sound Power	Cooling		dB(A)	59	59	60	65
Air Flow Rate	Cooling	S / L / M / H / Max. (Power)	m³/min	3.0 / 4.2 / 7.5 / 10.0 / 12.5	3.0 / 4.2 / 7.5 / 10.0 / 12.5	8.0 / 10.5 / 13.0 / 14.5 / 15.5	8.0 / 10.5 / 13.1 / 16.1 / 18.3
	Heating	L / M / H	m³/min	5.6 / 7.2 / 10.0	5.6 / 7.2 / 10.0	11.0 / 13.5 / 16.0	11.0 / 14.3 / 17.6
Dehumidification Rate			l/h	1.1	1.3	1.8	2.5
Running Current	Cooling	Min. / Rated / Max.	A	1.10 / 3.30 / 6.00	1.10 / 4.70 / 6.00	1.20 / 6.90 / 9.00	1.20 / 9.80 / 14.00
	Heating	Min. / Rated / Max.	A	1.10 / 4.00 / 7.00	1.10 / 4.70 / 7.00	1.20 / 7.10 / 9.50	1.20 / 10.00 / 14.00
Starting Current	Cooling / Heating	Rated	A	3.30 / 4.00	4.70 / 4.70	6.90 / 7.10	9.80 / 10.00
Power Supply			Ø / V / Hz	1 / 220-240 / 50	1 / 220-240 / 50	1 / 220-240 / 50	1 / 220-240 / 50
Circuit Breaker			A	15	15	20	25
Power Supply Cable			N x mm²	3 x 1.0	3 x 1.0	3 x 1.5	3 x 2.5
Power & Transmission Cable			N x mm²	4 x 1.0 (Including Earth)	4 x 1.0 (Including Earth)	4 x 1.0 (Including Earth)	4 x 1.0 (Including Earth)
Dimension			mm	837 x 308 x 189	837 x 308 x 189	998 x 345 x 210	998 x 345 x 210
Net Weight			kg	8.7	8.7	11.9	12.7
Fan Motor Output			W	30	30	30	58
OUTDOOR				PC09SQ UA3	PC12SQ UA3	PC18SQ UL2	PC24SQ U24
Operation Range	Cooling	Min. / Max.	°C DB	-10 / 48	-10 / 48	-15 / 48	-15 / 48
	Heating	Min. / Max.	°C DB	-10 / 24	-10 / 24	-10 / 24	-10 / 24
Sound Pressure	Cooling / Heating	High	dB(A)	48 / 50	48 / 50	53 / 55	54 / 57
Sound Power	Cooling	High	dB(A)	65	65	65	70
Air Flow Rate		High	m³/min	27	27	35	49
Piping	Liquid (ODU / IDU)	Min. / Max.	m	3 / 15	3 / 15	3 / 20	3 / 30
	Elevation (ODU / IDU)	Min. / Max.	m	7	7	10	15
Piping Connection	Liquid	OD (Outside)	mm (inch)	6.35 (1/4)	6.35 (1/4)	6.35 (1/4)	6.35 (1/4)
	Gas	OD (Outside)	mm (inch)	9.52 (3/8)	9.52 (3/8)	12.7 (1/2)	15.88 (5/8)
Drain Hose Size		OD (Outside)	mm (inch)	21.5 (27/32)	21.5 (27/32)	21.5 (27/32)	21.5 (27/32)
Refrigerant	Type		kg	R32	R32	R32	R32
	Charge at 7.5m		kg	0.700	0.700	1.000	1.100
	Additional Charge		t-CO ₂ eq	0.473	0.473	0.675	0.743
	GWP		g/m	20	20	20	20
Fan Motor Output			W	43	43	43	85
Compressor Type				Inverter Twin Rotary	Inverter Twin Rotary	Inverter Twin Rotary	Inverter Twin Rotary
Net Weight			kg	25.1	25.1	34.4	46.0
Dimension			mm	717 x 495 x 230	717 x 495 x 230	770 x 545 x 288	870 x 650 x 330
ACCESSORIES & OTHERS							
Multi Compatible				Y	Y	Y	Y
PI 485				-	-	-	-
Dry Contact				Y	Y	Y	Y
Wired Remote Controller				Y	Y	Y	Y

※ This product contains Fluorinated greenhouse gases (R32).
 ※ S : Sleep / L : Low / M : Medium / H : High
 ※ GWP : Global warming potential
 ※ t-CO₂eq : F-gas(kg)*GWP/1000
 ※ Specification, design and feature are subject to change without prior notice.

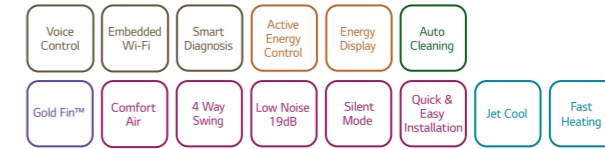

LG participates in the ECP programme for EUROVENT VRF program. Check ongoing validity of certification : www.eurovent-certification.com

Single Combination

UNIT				9K	12K	18K	24K
INDOOR				S09ET NSJ	S12ET NSJ	S18ET NSK	S24ET NSK
Capacity	Cooling	Min. / Rated / Max.	kW	0.89 / 2.50 / 3.70	0.89 / 3.50 / 4.04	0.90 / 5.00 / 5.50	0.90 / 6.60 / 7.42
	Heating	Min. / Rated / Max.	kW	0.89 / 3.30 / 4.10	0.89 / 4.00 / 5.10	0.90 / 5.80 / 6.40	0.90 / 7.50 / 8.64
	Heating -7°C	Rated	kW	2.60	3.00	4.20	6.00
Power Input	Cooling / Heating	Rated	W	656 / 800	1,080 / 1,050	1,562 / 1,611	2,164 / 2,238
EER			W/W	3.81	3.24	3.20	3.05
S.E.E.R.				7.00	6.60	7.00	6.90
P design C			kW	2.50	3.50	5.00	6.60
COP			W/W	4.13	3.81	3.60	3.35
S.C.O.P		(Average / Warmer)		4.00 / 4.90	4.00 / 4.90	4.30 / 5.30	4.30 / 5.30
P design H (Average / Warmer)			kW	2.50 / 1.30	2.50 / 1.30	3.90 / 2.10	5.00 / 2.70
Energy Label (A+++ to D Scale)	Cooling			A++	A++	A++	A++
	Heating	(Average / Warmer)		A+ / A++	A+ / A++	A+ / A+++	A+ / A+++
Annual Energy Consumption	Cooling		kWh	125	186	250	335
	Heating	(Average / Warmer)	kWh	875 / 371	875 / 371	1,270 / 555	1,628 / 713
Sound Pressure	Cooling	S / L / M / H	dB(A)	19 / 27 / 35 / 41	19 / 27 / 35 / 41	31 / 34 / 39 / 44	31 / 34 / 42 / 47
	Heating	L / M / H	dB(A)	27 / 35 / 41	27 / 35 / 41	34 / 39 / 44	34 / 42 / 47
Sound Power	Cooling		dB(A)	59	59	60	65
Air Flow Rate	Cooling	S / L / M / H / Max. (Power)	m³/min	3.0 / 4.2 / 7.5 / 10.0 / 12.5	3.0 / 4.2 / 7.5 / 10.0 / 12.5	8.0 / 10.5 / 13.0 / 14.5 / 15.5	8.0 / 10.5 / 13.1 / 16.1 / 18.3
	Heating	L / M / H	m³/min	5.6 / 7.2 / 10.0	5.6 / 7.2 / 10.0	11.0 / 13.5 / 16.0	11.0 / 14.3 / 17.6
Dehumidification Rate			l/h	1.1	1.3	1.8	2.5
Running Current	Cooling	Min. / Rated / Max.	A	1.10 / 3.30 / 6.00	1.10 / 4.70 / 6.00	1.20 / 6.90 / 9.00	1.20 / 9.80 / 14.00
	Heating	Min. / Rated / Max.	A	1.10 / 4.00 / 7.00	1.10 / 4.70 / 7.00	1.20 / 7.10 / 9.50	1.20 / 10.00 / 14.00
Starting Current	Cooling / Heating	Rated	A	3.30 / 4.00	4.70 / 4.70	6.90 / 7.10	9.80 / 10.00
Power Supply			Ø / V / Hz	1 / 220-240 / 50	1 / 220-240 / 50	1 / 220-240 / 50	1 / 220-240 / 50
Circuit Breaker			A	15	15	20	25
Power Supply Cable			N x mm²	3 x 1.0	3 x 1.0	3 x 1.5	3 x 2.5
Power & Transmission Cable			N x mm²	4 x 1.0 (Including Earth)	4 x 1.0 (Including Earth)	4 x 1.0 (Including Earth)	4 x 1.0 (Including Earth)
Dimension			mm	837 x 308 x 189	837 x 308 x 189	998 x 345 x 210	998 x 345 x 210
Net Weight			kg	8.7	8.7	11.9	12.7
Fan Motor Output			W	30	30	30	58
OUTDOOR				S09ET UA3	S12ET UA3	S18ET UL2	S24ET U24
Operation Range	Cooling	Min. / Max.	°C DB	-10 / 48	-10 / 48	-15 / 48	-15 / 48
	Heating	Min. / Max.	°C DB	-10 / 24	-10 / 24	-10 / 24	-10 / 24
Sound Pressure	Cooling / Heating	High	dB(A)	48 / 50	48 / 50	53 / 55	54 / 57
Sound Power	Cooling	High	dB(A)	65	65	65	70
Air Flow Rate		High	m³/min	27	27	35	49
Piping	Liquid (ODU / IDU)	Min. / Max.	m	3 / 15	3 / 15	3 / 20	3 / 30
	Elevation (ODU / IDU)	Min. / Max.	m	7	7	10	15
Piping Connection	Liquid	OD (Outside)	mm (inch)	6.35 (1/4)	6.35 (1/4)	6.35 (1/4)	6.35 (1/4)
	Gas	OD (Outside)	mm (inch)	9.52 (3/8)	9.52 (3/8)	12.7 (1/2)	15.88 (5/8)
Drain Hose Size		OD (Outside)	mm (inch)	21.5 (27/32)	21.5 (27/32)	21.5 (27/32)	21.5 (27/32)
Refrigerant	Type		kg	R32	R32	R32	R32
	Charge at 7.5m		kg	0.700	0.700	1.000	1.100
	Additional Charge		t-CO ₂ eq	0.473	0.473	0.675	0.743
	GWP		g/m	20	20	20	20
Fan Motor Output			W	43	43	43	85
Compressor Type				Inverter Twin Rotary	Inverter Twin Rotary	Inverter Twin Rotary	Inverter Twin Rotary
Net Weight			kg	25.1	25.1	34.4	46.0
Dimension			mm	717 x 495 x 230	717 x 495 x 230	770 x 545 x 288	870 x 650 x 330
ACCESSORIES & OTHERS							
Multi Compatible				Y	Y	Y	Y
PI 485				-	-	-	-
Dry Contact				Y	Y	Y	Y
Wired Remote Controller				Y	Y	Y	Y

※ This product contains Fluorinated greenhouse gases (R32).
 ※ S : Sleep / L : Low / M : Medium / H : High
 ※ GWP : Global warming potential
 ※ t-CO₂eq : F-gas(kg)*GWP/1000
 ※ Specification, design and feature are subject to change without prior notice.



LG participates in the ECP programme for EUROVENT VRF program. Check ongoing validity of certification : www.eurovent-certification.com

Single Combination

UNIT				9K	12K	18K	24K
INDOOR				S09EQ NSJ	S12EQ NSJ	S18EQ NSK	S24EQ NSK
Capacity	Cooling	Min. / Rated / Max.	kW	0.89 / 2.50 / 3.70	0.89 / 3.50 / 4.04	0.90 / 5.00 / 5.50	0.90 / 6.60 / 7.42
	Heating	Min. / Rated / Max.	kW	0.89 / 3.30 / 4.10	0.89 / 4.00 / 5.10	0.90 / 5.80 / 6.40	0.90 / 7.50 / 8.64
Power Input	Heating -7°C	Rated	kW	2.60	3.00	4.20	6.00
	Cooling / Heating	Rated	W	656 / 800	1,080 / 1,050	1,562 / 1,611	2,164 / 2,238
EER			W/W	3.81	3.24	3.20	3.05
S.E.E.R.				7.00	6.60	7.00	6.90
P design C			kW	2.50	3.50	5.00	6.60
COP			W/W	4.13	3.81	3.60	3.35
S.C.O.P		(Average / Warmer)		4.00 / 4.90	4.00 / 4.90	4.30 / 5.30	4.30 / 5.30
P design H (Average / Warmer)			kW	2.50 / 1.30	2.50 / 1.30	3.90 / 2.10	5.00 / 2.70
Energy Label (A+++ to D Scale)	Cooling			A++	A++	A++	A++
	Heating	(Average / Warmer)		A+ / A++	A+ / A++	A+ / A+++	A+ / A+++
Annual Energy Consumption	Cooling		kWh	125	186	250	335
	Heating	(Average / Warmer)	kWh	875 / 371	875 / 371	1,270 / 555	1,628 / 713
Sound Pressure	Cooling	S / L / M / H	dB(A)	19 / 27 / 35 / 41	19 / 27 / 35 / 41	31 / 34 / 39 / 44	31 / 34 / 42 / 47
	Heating	L / M / H	dB(A)	27 / 35 / 41	27 / 35 / 41	34 / 39 / 44	34 / 42 / 47
Sound Power	Cooling		dB(A)	59	59	60	65
Air Flow Rate	Cooling	S / L / M / H / Max. (Power)	m³/min	3.0 / 4.2 / 7.5 / 10.0 / 12.5	3.0 / 4.2 / 7.5 / 10.0 / 12.5	8.0 / 10.5 / 13.0 / 14.5 / 15.5	8.0 / 10.5 / 13.1 / 16.1 / 18.3
	Heating	L / M / H	m³/min	5.6 / 7.2 / 10.0	5.6 / 7.2 / 10.0	11.0 / 13.5 / 16.0	11.0 / 14.3 / 17.6
Dehumidification Rate			l/h	1.1	1.3	1.8	2.5
Running Current	Cooling	Min. / Rated / Max.	A	1.10 / 3.30 / 6.00	1.10 / 4.70 / 6.00	1.20 / 6.90 / 9.00	1.20 / 9.80 / 14.00
	Heating	Min. / Rated / Max.	A	1.10 / 4.00 / 7.00	1.10 / 4.70 / 7.00	1.20 / 7.10 / 9.50	1.20 / 10.00 / 14.00
Starting Current	Cooling / Heating	Rated	A	3.30 / 4.00	4.70 / 4.70	6.90 / 7.10	9.80 / 10.00
Power Supply			Ø / V / Hz	1 / 220-240 / 50	1 / 220-240 / 50	1 / 220-240 / 50	1 / 220-240 / 50
Circuit Breaker			A	15	15	20	25
Power Supply Cable			N x mm²	3 x 1.0	3 x 1.0	3 x 1.5	3 x 2.5
Power & Transmission Cable			N x mm²	4 x 1.0 (Including Earth)	4 x 1.0 (Including Earth)	4 x 1.0 (Including Earth)	4 x 1.0 (Including Earth)
Dimension			mm	837 x 308 x 189	837 x 308 x 189	998 x 345 x 210	998 x 345 x 210
Net Weight			kg	8.7	8.7	11.9	12.7
Fan Motor Output			W	30	30	30	58
OUTDOOR				S09EQ UA3	S12EQ UA3	S18EQ UL2	S24EQ U24
Operation Range	Cooling	Min. / Max.	°C DB	-10 / 48	-10 / 48	-15 / 48	-15 / 48
	Heating	Min. / Max.	°C DB	-10 / 24	-10 / 24	-10 / 24	-10 / 24
Sound Pressure	Cooling / Heating	High	dB(A)	48 / 50	48 / 50	53 / 55	54 / 57
Sound Power	Cooling	High	dB(A)	65	65	65	70
Air Flow Rate		High	m³/min	27	27	35	49
Piping	Liquid (ODU / IDU)	Min. / Max.	m	3 / 15	3 / 15	3 / 20	3 / 30
	Elevation (ODU / IDU)	Min. / Max.	m	7	7	10	15
Piping Connection	Liquid	OD (Outside)	mm (inch)	6.35 (1/4)	6.35 (1/4)	6.35 (1/4)	6.35 (1/4)
	Gas	OD (Outside)	mm (inch)	9.52 (3/8)	9.52 (3/8)	12.7 (1/2)	15.88 (5/8)
Drain Hose Size		OD (Outside)	mm (inch)	21.5 (27/32)	21.5 (27/32)	21.5 (27/32)	21.5 (27/32)
Refrigerant	Type			R32	R32	R32	R32
	Charge at 7.5m		kg	0.700	0.700	1.000	1.100
	Additional Charge		t-CO ₂ eq	0.473	0.473	0.675	0.743
	GWP		g/m	20	20	20	20
Fan Motor Output			W	675	675	675	675
Compressor Type				Inverter Twin Rotary	Inverter Twin Rotary	Inverter Twin Rotary	Inverter Twin Rotary
Net Weight			kg	25.1	25.1	34.4	46.0
Dimension			mm	717 x 495 x 230	717 x 495 x 230	770 x 545 x 288	870 x 650 x 330
ACCESSORIES & OTHERS							
Multi Compatible				-	-	-	-
PI 485				-	-	-	-
Dry Contact				-	-	-	-
Wired Remote Controller				-	-	-	-

※ This product contains Fluorinated greenhouse gases (R32).
 ※ S : Sleep / L : Low / M : Medium / H : High
 ※ GWP : Global warming potential
 ※ t-CO₂eq : F-gas(kg)*GWP/1000
 ※ Specification, design and feature are subject to change without prior notice.



LG participates in the ECP programme for EUROVENT VRF program. Check ongoing validity of certification : www.eurovent-certification.com

Single Combination

UNIT				9K	12K
INDOOR				S09EH NSA	S12EW NSJ
Capacity	Cooling	Min. / Rated / Max.	kW	0.89 / 2.50 / 3.25	0.89 / 3.5 / 4.04
	Heating	Min. / Rated / Max.	kW	0.89 / 3.20 / 3.85	0.89 / 4.0 / 5.1
Power Input	Heating -7°C	Rated	kW	2.6	3.0
	Cooling / Heating	Rated	W	715 / 860	1080 / 1050
EER			W/W	3.24	3.24
S.E.E.R.				6.50	6.6
P design C			kW	2.5	3.5
COP			W/W	3.72	3.81
S.C.O.P		(Average / Warmer)		4.0 / 4.8	4.0 / 4.9
P design H (Average / Warmer)			kW	2.3 / 1.3	2.5 / 1.3
Energy Label (A+++ to D Scale)	Cooling			A++	A++
	Heating	(Average / Warmer)		A+ / A++	A+ / A++
Annual Energy Consumption	Cooling		kWh	135	186
	Heating	(Average / Warmer)	kWh	805 / 379	875 / 371
Sound Pressure	Cooling	S / L / M / H	dB(A)	22 / 28 / 36 / 42	19 / 27 / 35 / 41
	Heating	L / M / H	dB(A)	31 / 36 / 42	27 / 35 / 41
Sound Power	Cooling		dB(A)	60	59
Air Flow Rate	Cooling	S / L / M / H / Max. (Power)	m³/min	2.0 / 5.7 / 8.0 / 9.5	3.0 / 4.2 / 7.5 / 10.0
	Heating	L / M / H	m³/min	4.0 / 5.5 / 8.5	5.6 / 7.2 / 10.0
Dehumidification Rate			l/h	1.10	1.30
Running Current	Cooling	Min. / Rated / Max.	A	1.1 / 3.3 / 6.0	1.1 / 4.7 / 6.0
	Heating	Min. / Rated / Max.	A	1.1 / 4.0 / 7.0	1.1 / 4.7 / 7.0
Starting Current	Cooling / Heating	Rated	A	3.3 / 4.0	4.7 / 4.7
Power Supply			Ø / V / Hz	1/220-240/50	1/220-240/50
Circuit Breaker			A	15	15
Power Supply Cable			N x mm²	3 x 1.0	3 x 1.0
Power & Transmission Cable			N x mm²	4 x 1.0 (Including Earth)	4 x 1.0 (Including Earth)
Dimension			mm	754 x 308 x 189	837 x 308 x 189
Net Weight			kg	7.8	8.7
Fan Motor Output			W	30	30
OUTDOOR				S09EH UA3	S12EW UA3
Operation Range	Cooling	Min. / Max.	°C DB	18 / 48	-10 / 48
	Heating	Min. / Max.	°C DB	-5 / 24	-10 / 24
Sound Pressure	Cooling / Heating	High	dB(A)	48 / 50	48 / 50
Sound Power	Cooling	High	dB(A)	65	65
Air Flow Rate		High	m³/min	27	27
Piping	Liquid (ODU / IDU)	Min. / Max.	m	3 / 15	3 / 15
	Elevation (ODU / IDU)	Min. / Max.	m	7	7
Piping Connection	Liquid	OD (Outside)	mm (inch)	6.35 (1/4)	6.35 (1/4)
	Gas	OD (Outside)	mm (inch)	9.52 (3/8)	9.52 (3/8)
Drain Hose Size		OD (Outside)	mm (inch)	21.5 (27/32)	21.5 (27/32)
Refrigerant	Type			R32	R32
	Charge at 7.5m		kg	0.670	0.700
	Additional Charge		t-CO ₂ eq	0.452	0.473
	GWP		g/m	20	20
Fan Motor Output			W	675	675
Compressor Type				Inverter Twin Rotary	Inverter Twin Rotary
Net Weight			kg	26	26
Dimension			mm	717 x 495 x 230	717 x 495 x 230
ACCESSORIES & OTHERS					
Multi Compatible				-	-
PI 485				-	-
Dry Contact				-	-
Wired Remote Controller				-	-

※ This product contains Fluorinated greenhouse gases (R32).
 ※ S : Sleep / L : Low / M : Medium / H : High
 ※ GWP : Global warming potential
 ※ t-CO₂eq : F-gas(kg)*GWP/1000
 ※ Specification, design and feature are subject to change without prior notice.

A09FT NSF / A12FT NSF

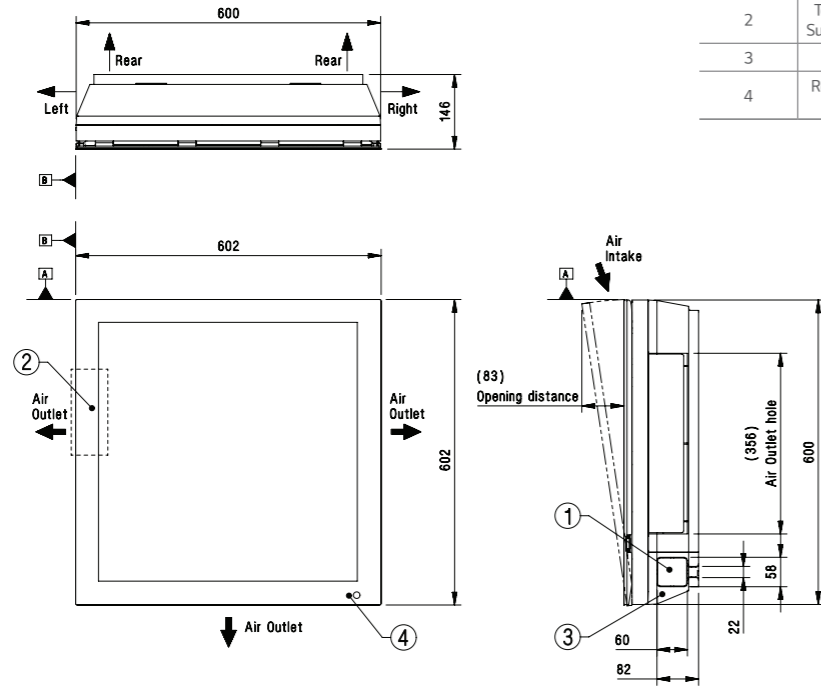

(Unit : mm)

ITEM NO.	PART NAME	REMARK
1	Refrigerant/Drain pipe and cable routing hole	Knock-out type
2	Terminal Block for Power Supply and Communication	Inside of front panel
3	Corner Cover	-
4	Remote Controller Signal Receiver	for wireless type

AC18BH NSK / AC24BH NSK

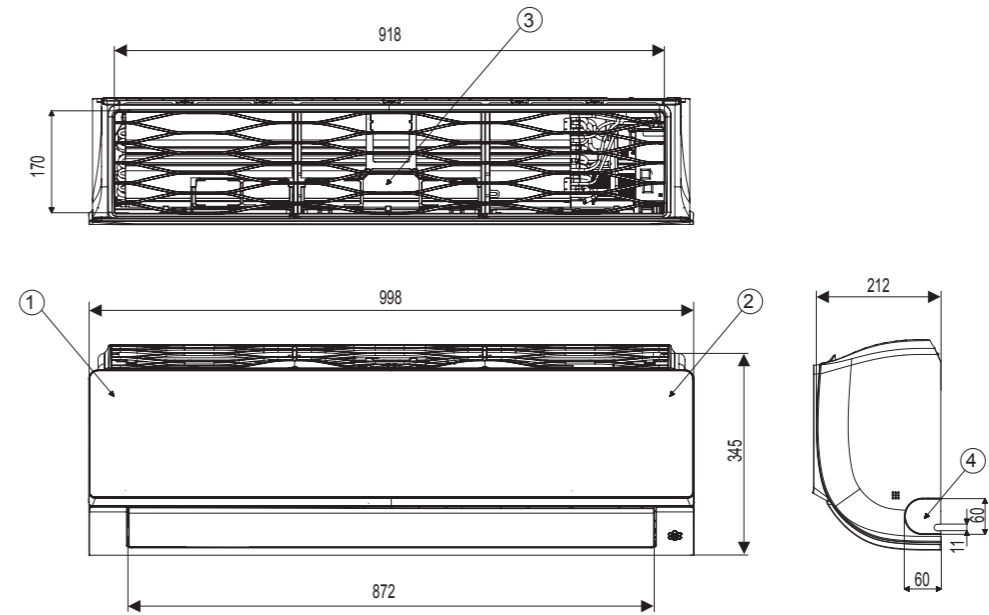

(Unit : mm)

ITEM NO.	PART NAME	REMARK
1	Front Panel	
2	Display & Signal Receiver	
3	Air Suction Filter	
4	Installation Plate	

AC09BH NSJ / AC12BH NSJ

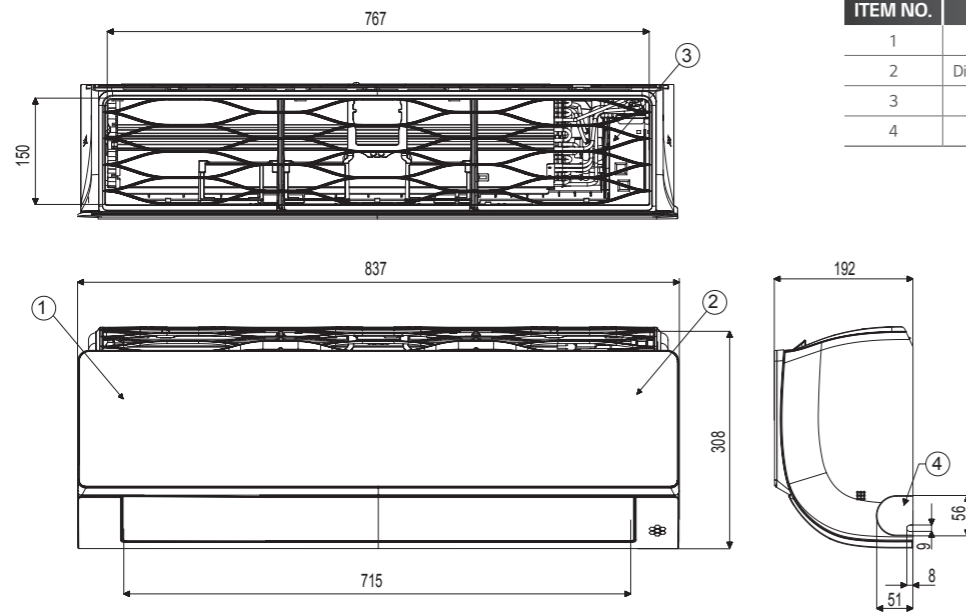

(Unit : mm)

ITEM NO.	PART NAME	REMARK
1	Front Panel	
2	Display & Signal Receiver	
3	Air Filter	
4	Knockout hole	For pipe and cable

F09MT NSM / F12MT NSM

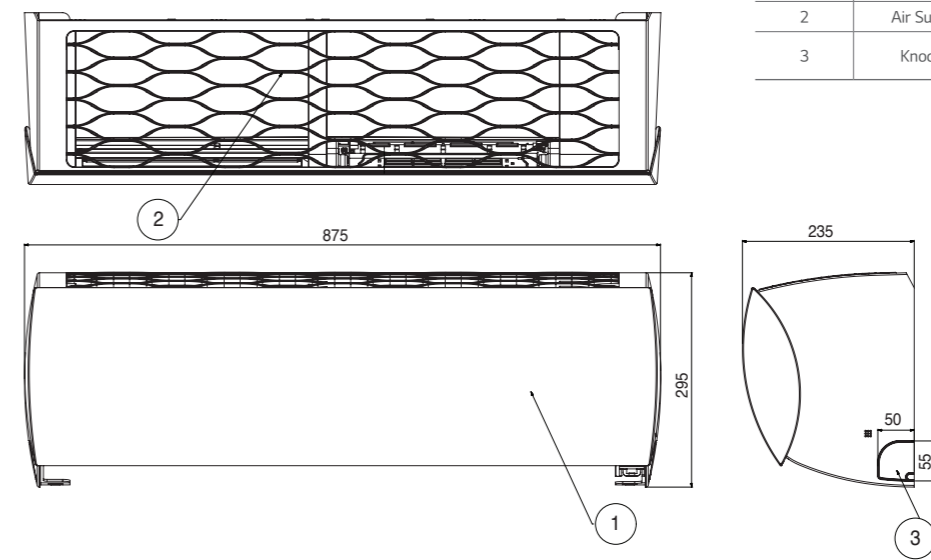

(Unit : mm)

ITEM NO.	PART NAME	REMARK
1	Front Panel	
2	Air Suction Grille	
3	Knockout Hole	For pipe and cable

AP09RT NSJ / AP12RT NSJ

(Unit : mm)

ITEM NO.	PART NAME	REMARK
1	Front Panel	
2	Display & Signal Receiver	Hidden
3	Air Filter	
4	Knockout hole	For pipe and cable

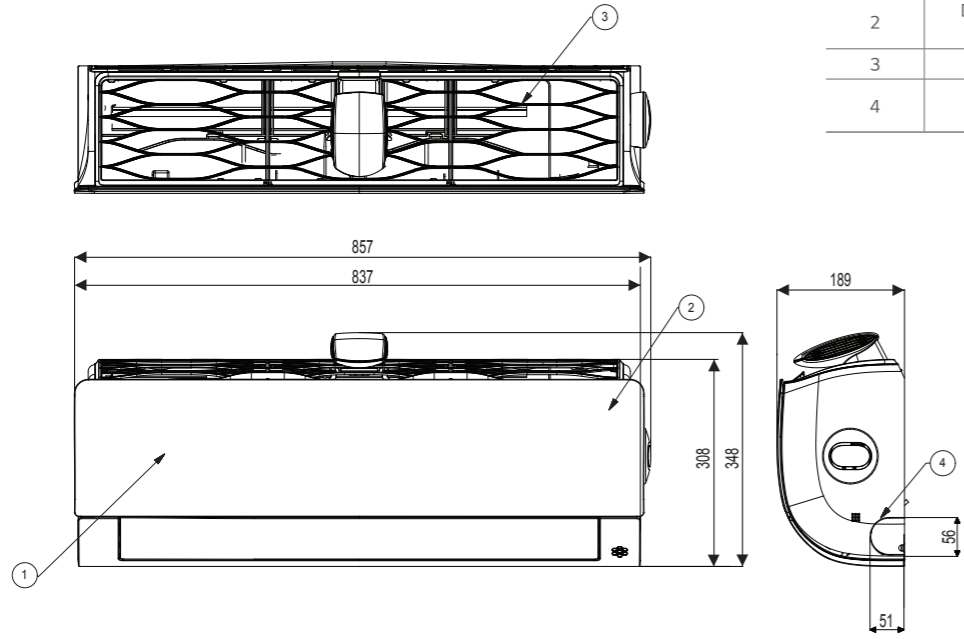

DC18RH NSK / DC24RH NSK / PC18SQ NSK / PC24SQ NSK
S18EQ NSK / S24EQ NSK / S18ET NSK / S24ET NSK

(Unit : mm)

ITEM NO.	PART NAME	REMARK
1	Front Panel	
2	Display & Signal Receiver	Hidden
3	Air Filter	
4	Knockout hole	For pipe and cable

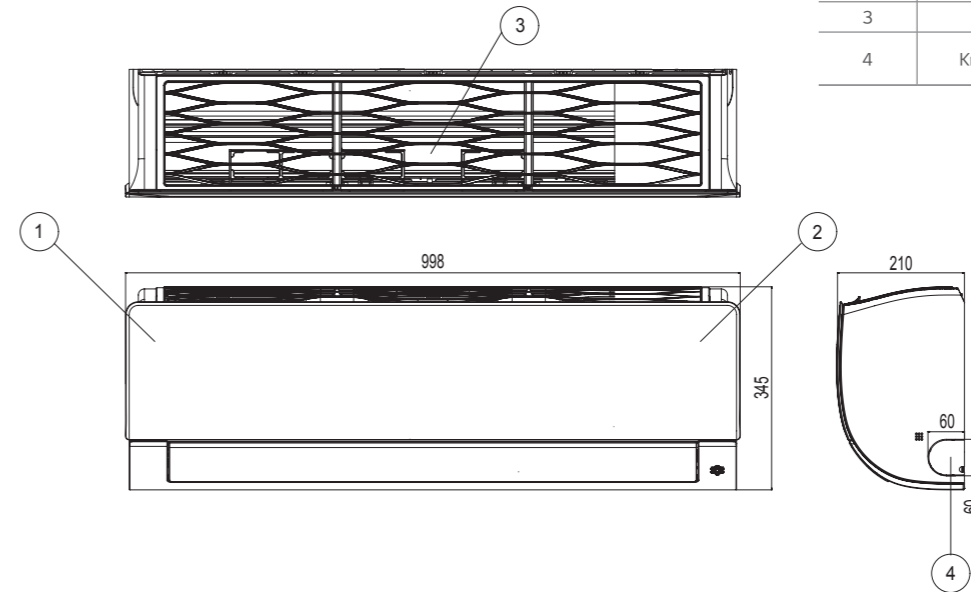

DC09RH NSJ / DC12RH NSJ / DC09RT NSJ / DC12RT NSJ / PC09SQ NSJ
PC12SQ NSJ / S09EQ NSJ / S12EQ NSJ / S09ET NSJ / S12ET NSJ / S12EW NSJ

(Unit : mm)

ITEM NO.	PART NAME	REMARK
1	Front Panel	
2	Display & Signal Receiver	Hidden
3	Air Filter	
4	Knockout hole	For pipe and cable

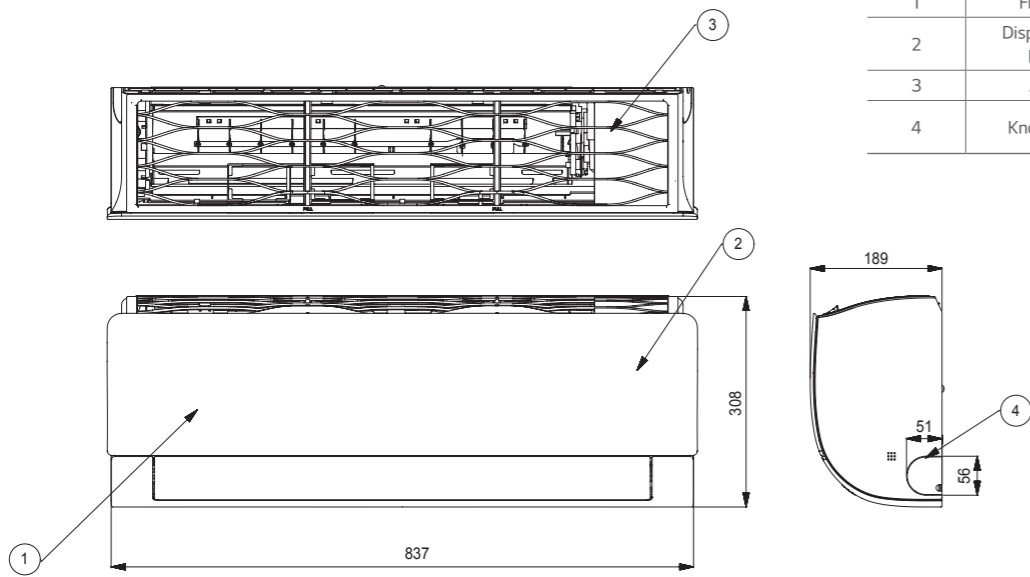

S09EH NSA

(Unit : mm)

ITEM NO.	PART NAME	REMARK
1	Front Panel	
2	Display & Signal Receiver	Hidden
3	Air Filter	
4	Knockout hole	For pipe and cable

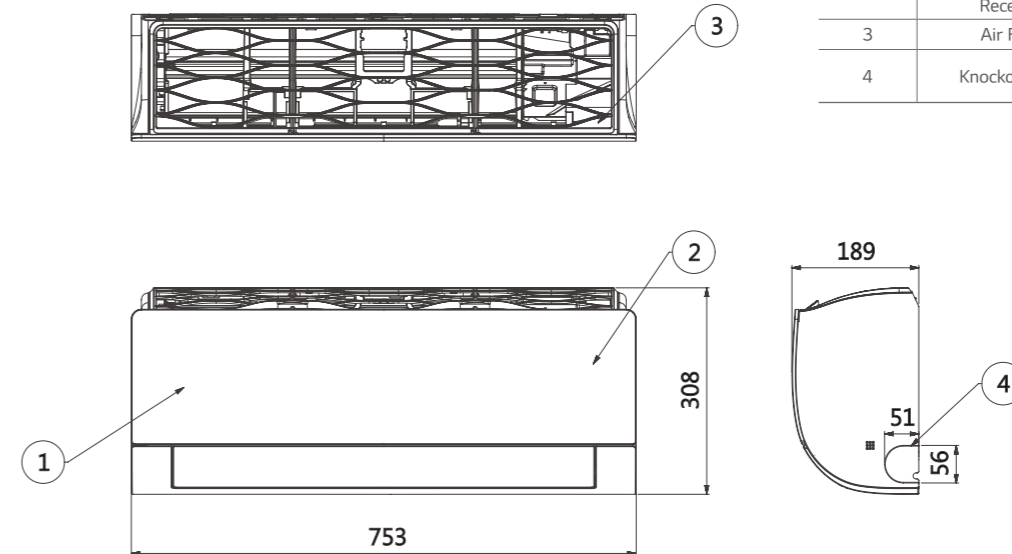

AC09BH UA3 / AC12BH UA3 / AC09SQ UA3 / AC12SQ UA3 / DC09RT UA3
 DC12RT UA3 / PC09SQ UA3 / PC12SQ UA3 / S09EQ UA3 / S12EQ UA3
 S09ET UA3 / S12ET UA3 / S12EW UA3 / AP09RT UA3 / AP12RT UA3 / S09EH UA3

(Unit: mm)

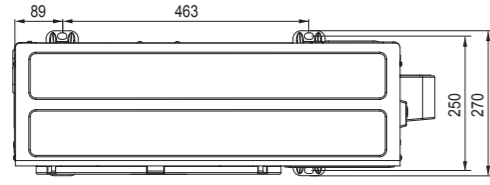

ITEM NO.	PART NAME
1	Air Outlet
2	Control Box
3	Power and Communication Cable Hole
4	Service Valve Cover
5	Gas Pipe Connection
6	Liquid Pipe Connection

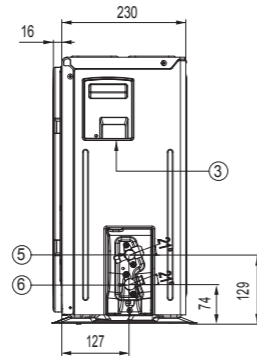
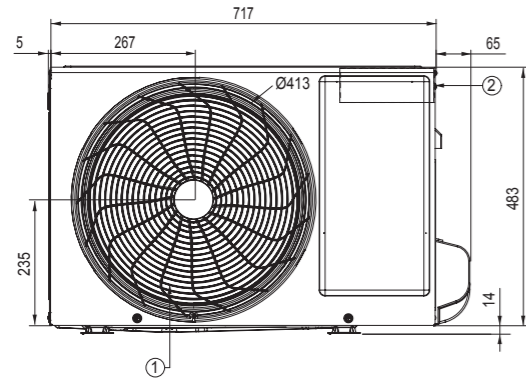

F09MT U24 / F12MT U24 / AC24BH U24 / DC24RH U24
 PC24SQ U24 / S24EQ U24 / S24ET U24

(Unit: mm)

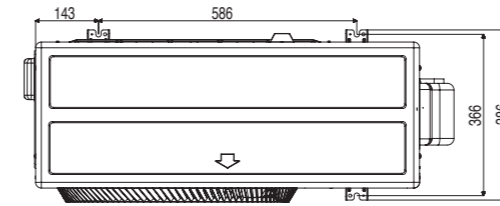

ITEM NO.	PART NAME
1	Air Outlet
2	Control Box
3	Power and Communication Cable Hole
4	Service Valve Cover
5	Gas Pipe Connection
6	Liquid Pipe Connection

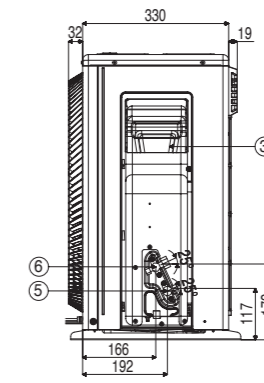
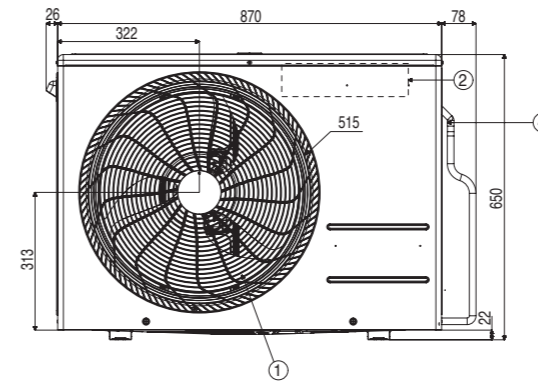

A09FT UL2 / A12FT UL2 / DC09RH UL2 / DC12RH UL2 / AC18BH UL2
 AC18SQ UL2 / DC18RH UL2 / PC18SQ UL2 / S18EQ UL2 / S18ET UL2

(Unit: mm)

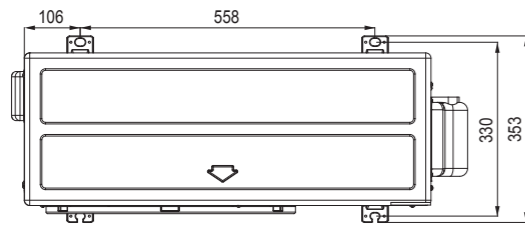

ITEM NO.	PART NAME
1	Air Outlet
2	Control Box
3	Power and Communication Cable Hole
4	Service Valve Cover
5	Gas Pipe Connection
6	Liquid Pipe Connection

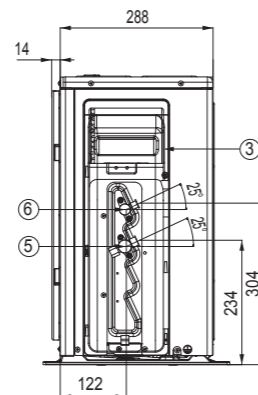
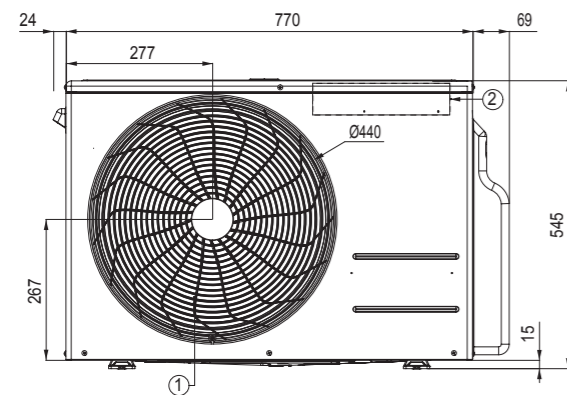

	ARTCOOL			DUALCOOL						
	Gallery	Mirror	Prestige	Air Purification	DELUXE	Deluxe2	Standard Plus	Standard2	Standard	Standard3
Wired Remote Controller	5k						Y			
	7k		Y				Y	Y		
	9k	-	Y	Y	Y	Y	Y	Y	-	-
	12k	-	Y	Y	Y	Y	Y	Y	-	-
	15k						Y			
	18k		Y			Y		Y	-	
PI 485	5k						-			
	7k		-			Y*		-		
	9k	Y	-	-	-	Y*	Y*	-	-	-
	12k	Y	-	-	-	Y*	Y*	-	-	-
	15k									
	18k		-			Y*		-	-	-
Dry Contact	5k						Y			
	7k		Y			Y	Y	Y		
	9k	Y	Y	Y	Y	Y	Y	Y	-	-
	12k	Y	Y	Y	Y	Y	Y	Y	-	-
	15k						Y			
	18k		Y			Y		Y	-	
24k		Y			Y		Y	-		

* Y : Available
 * When connected to Multi 14k & 16k Outdoor units, this may not be supported.

Standard Wired Remote Controller



Model Name	PREMTB100 PREMTBB10	PREMTB001 PREMTBB01
Operation Mode	On / Off, Fan Speed Control, Temperature Setting	
Mode Change	Cooling, Heating, Auto, Dehumidification, Fan	
Auto Swing / Vane Control	•	•
Reservation	Simple, Sleep, On / Off, Weekly, Holiday	
Time Display	•	•
Electrical Failure Compensation	•	•
Child Lock	•	•
Operation Status LED	•	•
Indoor Temperature Display	•	•
Wireless Remote Controller Receiver	-	•
Size (W x H x D, mm)	120 x 120 x 16	120 x 121 x 16
Backlight	•	•
Display AirQuality Status	-	-

※ Refer to each model PDB for applicable models.

PI 485



PMNFP14A1

Power : Single phase AC 220V 50/60Hz
 Max. no of the indoor units that can be connected : 64 UNITS
 Model applied : RAC / Multi / Single / Therma V
 ※ Refer to each product PDB for applicable models.

Dry Contact



※ Refer to each product PDB for applicable models.

Model	PDRYCB000	PDRYCB400	PDRYCB320	PDRYCB500
Contact Point	1 Control Point	2 Control Point	8 Control Point	Modbus RTU
Power Input	AC 220V from outside power source	DC 5V & 12V from indoor unit PCB	DC 5V & 12V from indoor unit PCB	DC 5V & 12V from indoor unit PDB
Voltage / Non Voltage Input	-	•	•	-
On / Off Control	•	•	•	•
Lock / Unlock	•	•	•	-
Fan Speed Setting	-	-	•	•
Thermo Off	-	•	•	-
Energy Saving	-	•	-	-
Temperature Setting	-	•	•	•
Error Monitoring	•	•	•	•
Operation Monitoring	•	•	•	•

Remote Controller



Prestige
 Artcool
 Deluxe, Deluxe2,
 Standard Plus
 Standard, Standard2, Standard3

Button	Display Screen	Description
	-	To turn on / off the air conditioner.
	88°C	To adjust the desired room temperature in cooling, heating or auto changeover mode.
COMFORT AIR	-	To adjust the air flow to indirect wind.
LIGHT OFF	-	To set the brightness of the display on the indoor unit.
MODE		To select the cooling mode.
		To select the heating mode.
		To select the dehumidification mode.
		To select the fan mode.
FAN SPEED		To select the auto changeover / auto operation mode.
		To adjust the fan speed.
ENERGY CTRL.	-	To bring the effect of the power saving.
JET MODE	Po	To change room temperature quickly.
		To adjust the air flow direction vertically or horizontally.
ROOM TEMP		To display the room temperature.
°C ↔ °F[5sec]	°C/°F	To change unit between °C and °F.
SET/ CANCEL	-	To set / cancel the functions and timer.
	-	To adjust time.
	-	To turn on / off air conditioner automatically.
	-	To cancel the timer settings.

※ Remote Controller specifications may vary for each model.
 ※ Remote Controller specification, design and feature are subject to change without prior notice.

PORTABLE AIR CONDITIONER



01 FAST COOLING

The Need for Speed

LG's Portable Air Conditioner reaches the optimal temperature more quickly than on-off compressors with variable speed operations.

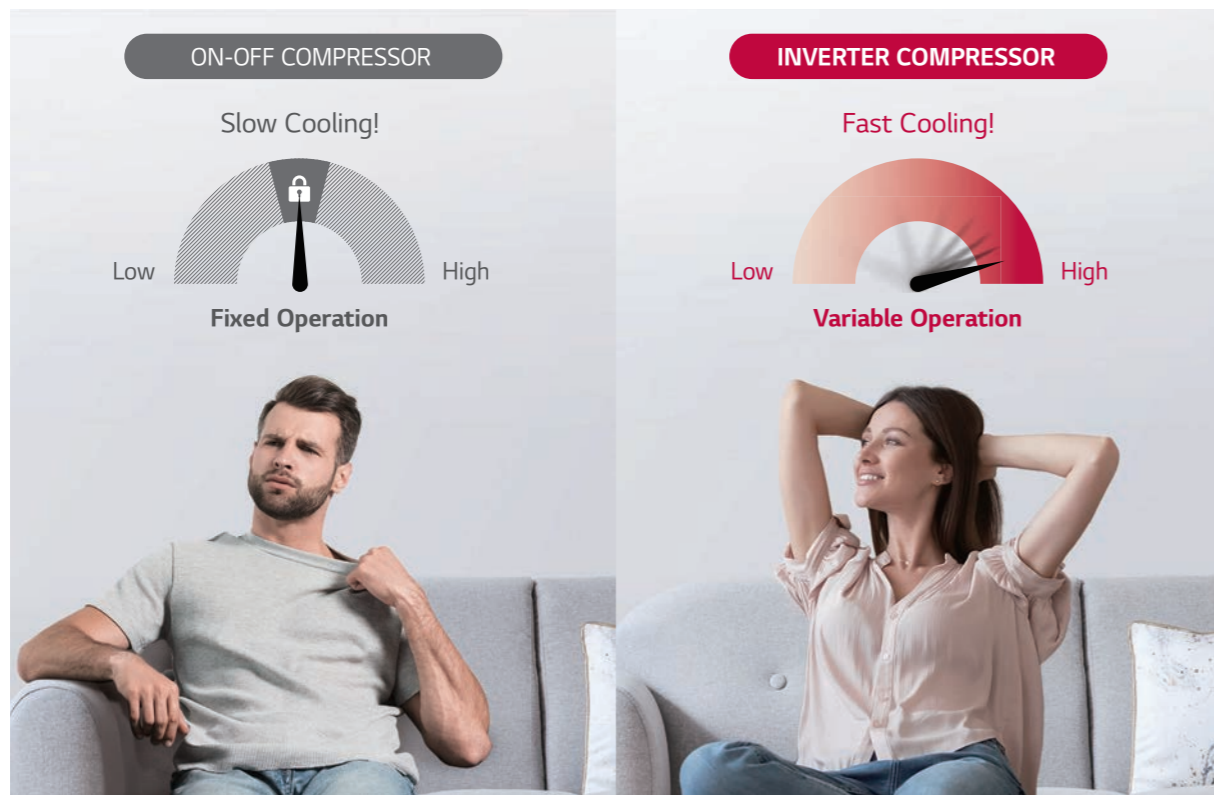

* Testing by TUV shows LG inverter air conditioner (US-Q242K*) cools up to 40% more faster than LG non-inverter air conditioner (TS-H2465DA0).
* TUV report No. 50068748 001

Portable Comfort at Home

LG Portable Air Conditioner DUAL Inverter provides optimized high-speed airflow, which can cool rooms faster.



※ How it works : One Click "Jet Mode"

02 LOW NOISE

Peace and Quiet

The LG inverter compressor operates more quietly at 42dB for indoor tranquility.

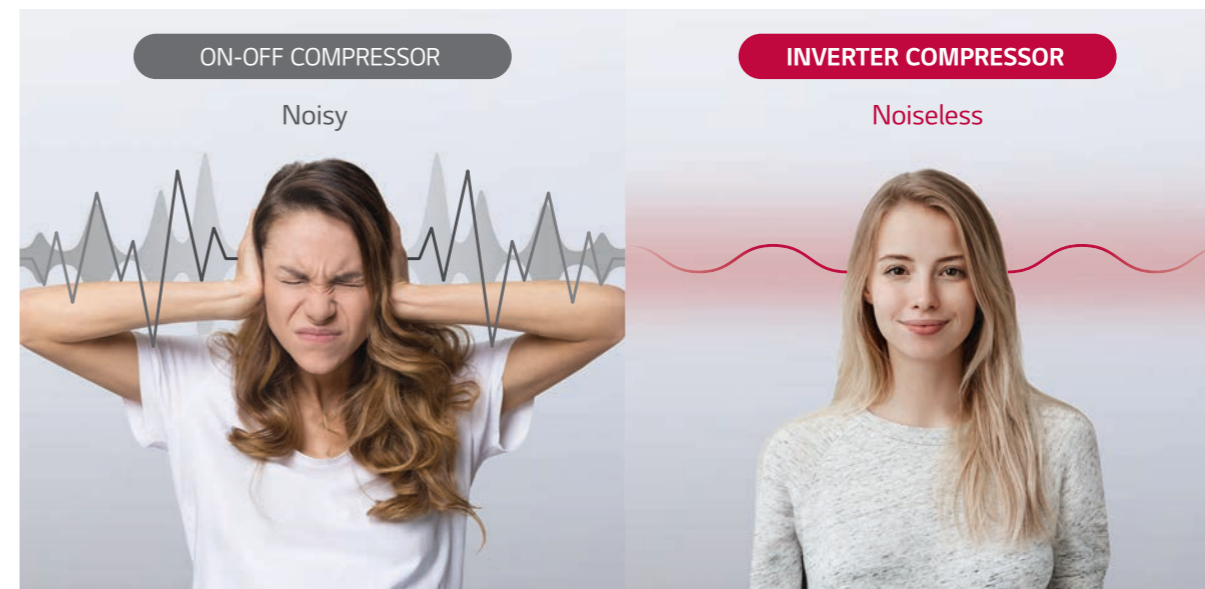

*Lo-Decibel™

LG Portable Air Conditioner DUAL Inverter operates at low sound levels as low as 42dB*, thanks to LG's unique BLDC Motor and DUAL Inverter Compressor™

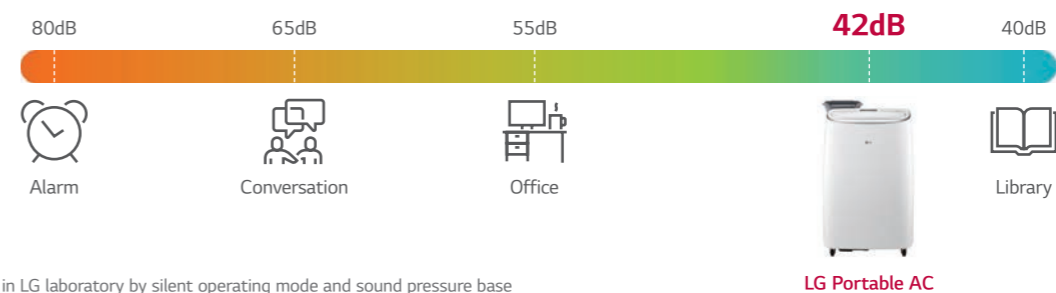

* Tested in LG laboratory by silent operating mode and sound pressure base
* Since this product has a compressor inside, it may cause mechanical noise during operation.

What is LG Inverter Technology?

LG Inverter Technology can be found in many of LG's renowned devices, from refrigerators and washing machines to our air conditioner line-up. This technology allows the inverter compressor to achieve superior energy efficiency, cooling performance and comfort compared to compressors with on-off capabilities.



03 CLEAN AIR

Say Goodbye to Odor

Auto-cleaning functions and two easily washable filters provide clean air

The auto cleaning function prevents potentially harmful substances from forming on the surface of the heat exchanger.

The indoor environment remains odorless with the advanced deodorizing function.

By preventing polluting of the heat exchanger caused by various germs and bacteria.

※ Drying conditions may vary depending on the environment of use.

Washable Filters

LG has filters in the upper and lower suction areas respectively. Without the bottom filter, dust can continue to enter the product, resulting in poor performance or drainage problems.

OTHER

Filter (Washable)
Lack of filter in suction area below

LG

2 washable filters

04 EASY STORAGE

Convenient Anytime, Anywhere Access

Easy storage of exhaust hose and window (sliding) sealing plate

INCONVENIENT

Separate exhaust hose from product (Cannot store as an all-in-one)
Inconvenient power cord storage

CONVENIENT

Ease-to-store power cord using an attached hook
Convenient storage of the exhaust hose and window sealing plate

Easy Installation

The installation kit and hose make it easy to install and store, saving you space. Smooth gliding caster wheels allow you to move it around the home and office.



05 CONVENIENT

No More Remote Control

Simple, time-saving voice control for easy access

OK Google, turn on the air conditioner.

Sure, turning on

- Voice command to AI Speaker
- AI Speaker changes user input from voice to text
- AI Speaker server recognizes user is invoking the Appliance skill, passing the user's intent to LG Server
- LG Server activates appliance

※ Smart features and voice assistant product may vary by country and model. Check with your local LG office or retailer for service availability

Smart Control

Control key features by using the ThinQ app on your smartphone and get important notifications from anywhere

LG ThinQ®

- Controlling & Monitoring
- Integrated Home Appliances Control
- Air Conditioner Control with Wi-Fi

3 in 1 Operation

The cool mode is ideal for powerful cooling and dehumidifying on hot days. In fan mode, the fan circulates air while the dry mode is ideal for rainy and damp days

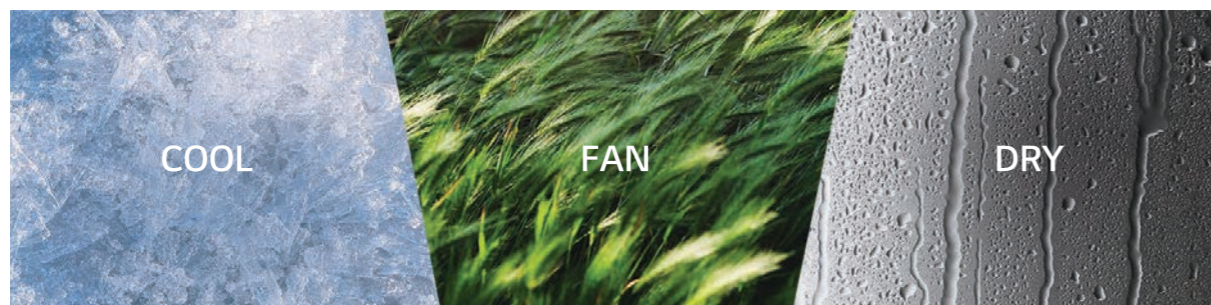

MODEL	PA11WS		
Performance	Capacity	Min. / Rated / Max. W	600 / 2,500 / 2,600
	Power Input	Rated / Max. W	805 / 910
	EER	W/W	3.1
	Energy Label (A+++ to D Scale)		A+
	Sound Pressure	S / L / M / H / Max. dB(A)	42 / 44 / 47 / 50 / 53
	Sound Power	Power dB(A)	65
	Air Flow Rate	S / L / M / H m ³ /min	3.8 / 4.2 / 5.0 / 6.6
		Max. (Power) m ³ /min	7
	Dehumidification Rate	l/h	1.2
	Power Supply	Ø / V / Hz	1 / 220-240 / 50
Refrigerant	Type		R290
	Pre Charge	kg	0.220
	t-CO ₂ eq		0.001
	GWP		3
Compressor Type			Inverter Twin Rotary
Dimensions	Product Net size (W x H x D) (mm)		493 x 773 x 460
	Net Weight (kg)		30.0
	Hose Diameter (mm)		150
	Hose Length (m)		1.5
Features	Embedded Wi-Fi (LG ThinQ)		Yes
	Voice Control		Yes
	Operation Mode		Cool / Dry / Fan
	Auto Evaporating System		Yes
	Remote Controller		LCD Remote Controller
	Air Direction		2 Way Swing
	Auto Restart		Yes
	Auto Clean		Yes
	Child Lock		Yes
	Water Full Indicator		Yes
	Timer		24hr, On/Off
	Air Filter (2 EA)		Washable
	Light On/Off		Dimming (100 / 50 / 0)

※ GWP : Global warming potential
 ※ t-CO₂eq : F-gas(kg)*GWP/1000
 ※ Specification, design and feature are subject to change without prior notice.

HEAT PUMP WATER HEATER

THERMA V

OVER
70%
Energy Saving

30%
Faster
Water Heating



What is a Heat Pump Water Heater?

With an increasing emphasis on eco-conscious energy solutions, the LG Heat Pump Water Heater obtains 75% of its energy from outside air. This renewable energy source converts low temperature to high temperature using two heat exchangers, a condenser and an evaporator.

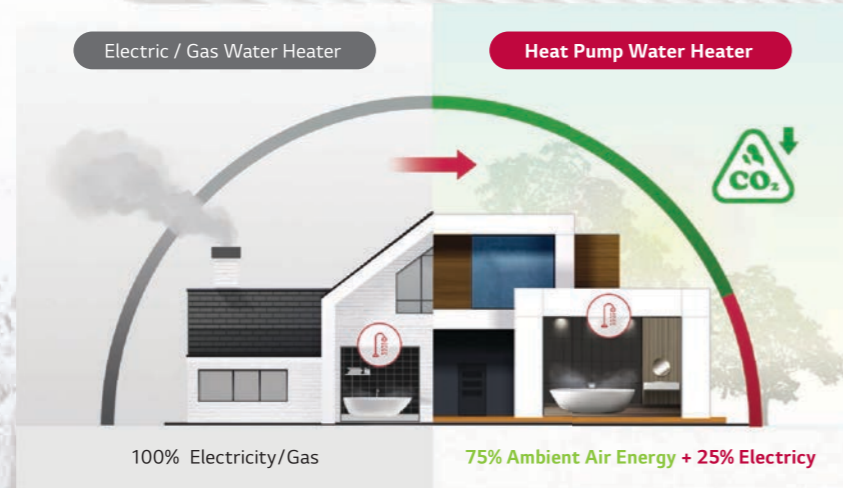

* LG Inverter Technology

LG Inverter Technology can be found in many of LG's renowned devices, from refrigerators and washing machines to our air conditioner line-up. This technology allows the inverter compressor to achieve superior energy efficiency, cooling performance and comfort compared to compressors with on-off capabilities.

Power Consumption Change

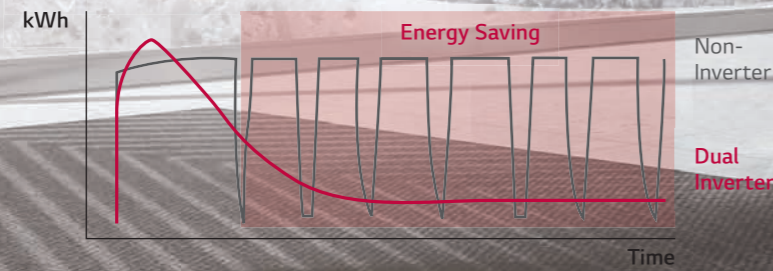

Flexible Installation Locations



Laundry Room



Storage Room



Bathroom



Bathroom



Garage



Garage

※ Actual product appearance may differ from the above simulated scene.

Stylish Design

LG's exclusive square design and luxury silver color make it an excellent design for the interior.



Perfect Matching with Various Spaces



Top Class Energy Efficiency

LG's new Inverter Heat Pump Water Heater allows for an impressive energy savings of over 70% compared to a conventional electric heater due to the highly efficient DUAL Inverter Compressor.



Energy Saving

LG's Heat Pump Water Heater, using market's first DUAL Inverter Compressor, DUAL Inverter Compressor can run at low rotational speed (up to 10Hz) and reduces energy consumption, 70% more than Electric Water Heater (250L, C class).

Average Estimated Energy Consumption Saving Per Year

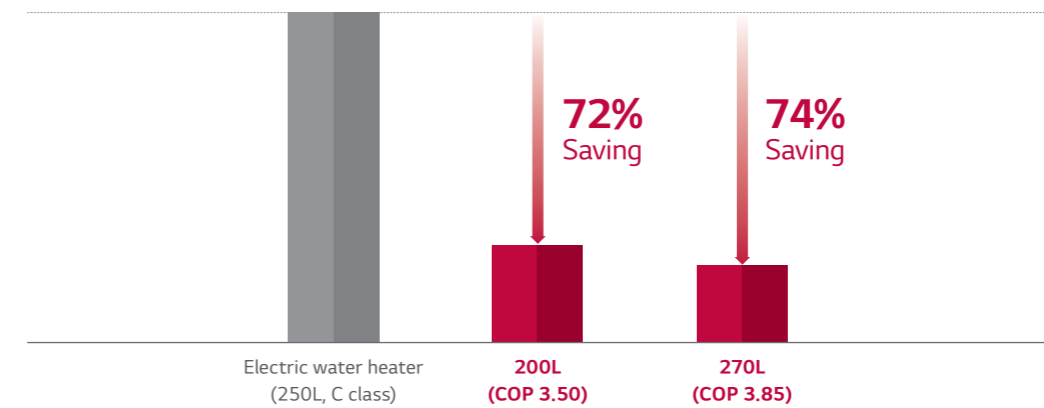

※ Simulation Data on Daily Electricity Consumption, based on EU Climate Condition (Average, 15°C).
 ※ Data is based on LG Internal Simulation.
 ※ The data is depending on the experimental condition and is changeable according to the usage environment

Powerful Heating Performance

The DUAL Inverter Compressor maximizes the heat pump's power in turbo mode for a 30% faster heating time for first-use water than auto mode operation.



Fast & Powerful Water Heating

Turbo Mode can run at high speeds (up to 80Hz) with simultaneous heating. The target water temperature in the tank will be achieved 30% faster in Turbo Mode than in Use auto mode or Auto Mode. Furthermore, Turbo Mode can recover the water at 25% warmer temperatures than Use auto mode or Auto Mode after 1 hour from an empty tank.

- ※ The data is based on LG internal test and simulation.
- ※ The data is depending on the experimental condition and is changeable according to the usage environment

Continuous Operation

The two heat sources, two heaters and heat pump, complement each other perfectly. If one of the heaters or the heat pump fails, the other heat source allows alternative operation.

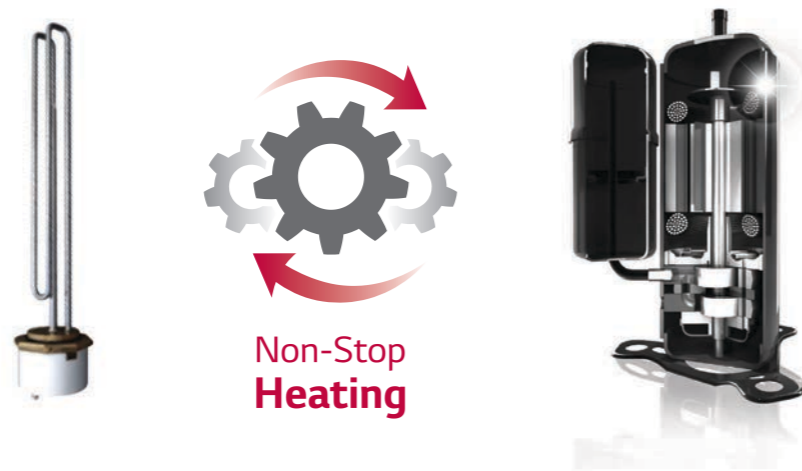

Non-Stop Heating

Low Noise Operation

Through BLDC Motor and DUAL Inverter Compressor, noise is reduced to 53dBA (sound power) and provides a comfortable environment even in indoor installation scenes.



Low Noise Operation

Through BLDC Fan Motor and DUAL Inverter Compressor, noise is reduced to 53dBA and creates a comfortable environment even in indoor installation scenes.

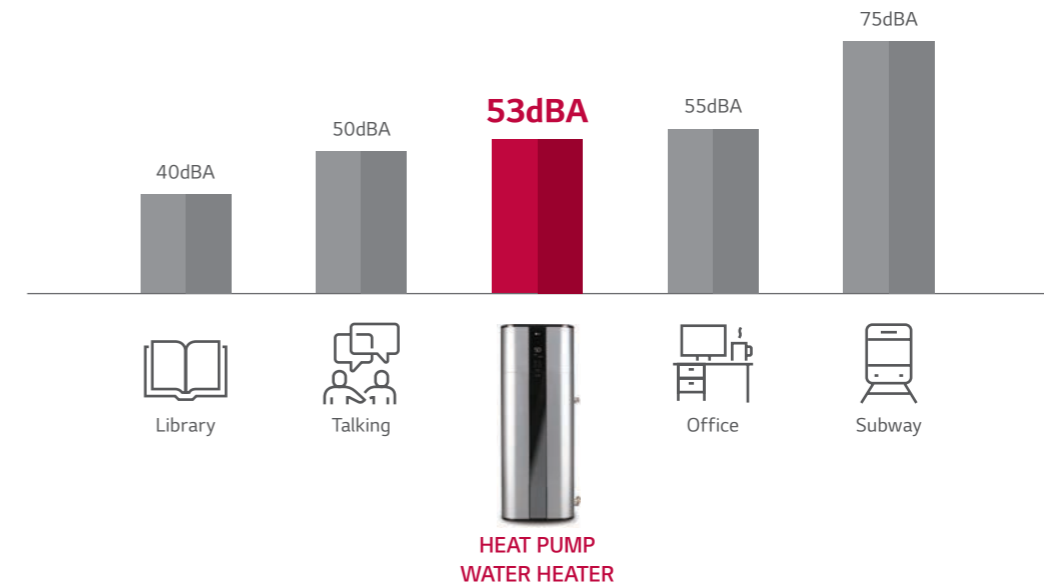

- ※ Sound Pressure is 38dBA based on LG internal test.
- ※ The data is based on LG Internal Test (Sound Power).
- ※ The data is based on LG internal test and simulation.
- ※ The data is depending on the experimental condition and is changeable according to the usage environment.

Various Operation Mode

LG Inverter Heat Pump Water Heater can be operated in 4 different modes for different conditions.

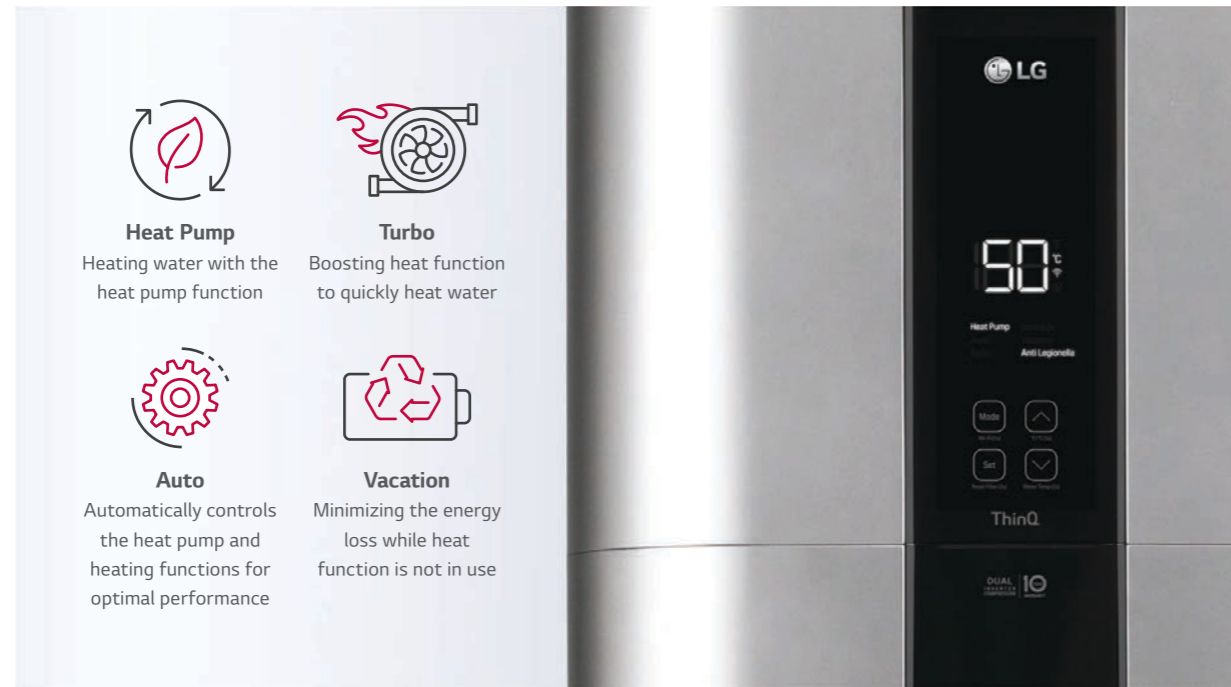

Operation



Using Basic Control

Display Screen

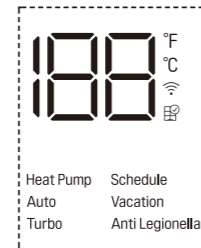

2 Display Screen

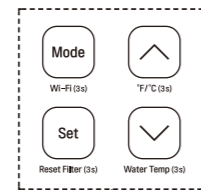

1 Button

Button	Display Screen	Description
Mode	Heat Pump	To select the Heat Pump mode.
	Auto	To select the Auto mode.
	Turbo	To select the Turbo mode.
	Vacation	To select the Vacation mode.
-	Schedule	Set Schedule mode only in LG ThinQ application.
-	Anti Legionella	To select the Anti Legionella mode.
Set	-	To set the desired water temperature.
↑ ↓	18.8	To adjust the desired water temperature.
Wi-Fi (3s)	Wi-Fi	To enable the Wi-Fi pairing.
Reset Filter (3s)	Filter	To reset the filter alarm.
°F/°C (3s)	°F °C	To change unit between °F and °C.
Water Temp (3s)	18.8	To display the current water temperature for 5 seconds.

Smart Control

With the LG ThinQ smartphone app, users can easily control and monitor the heat pump, checking for current water temperatures, setting operating schedules and more.



Embedded Wi-Fi

You can control the LG ThinQ app, checking information such as current water temperature, operating mode and more.



Smart Diagnosis

Smart Diagnosis allows users to conveniently check setup, installation, troubleshooting and other information directly from a smartphone.



Easy Check & Monitoring

Easily comprehensible error messages make detecting a solution and contacting the service center simple and convenient.



powered by
DUAL Inverter Compressor™

LG's DUAL Inverter Compressor™ saves energy with a wide power-saving operating range. Also, in max operation mode, it produces power heating to perform quiet and efficient heating.



Varied-Speed Dual Rotary

A compressor motor with a wider rotational frequency that is energy efficient and has a higher volumetric quick cooling capacity than conventional non-inverter compressor.

Product Reliability Improvement

As twin rotaries balance each other while they are rotating with high speed, it reduces noise dramatically compared to the shaking single rotary compressor. The reduction in vibration reduces the possibility of fractures occurring in the surrounding pipework.

- ※ The data is based on LG internal test and simulation.
- ※ The data is depending on the experimental condition and is changeable according to the usage environment

Benefit & Verification

Reliable Air Conditioner
Product safety is emphasized by offering a 10-year warranty on the compressor to reassure customers about product durability.



Verification
TUV Rheinland, Long Term Accelerated-reliability Test & High Marginal Test



Twin Rotary Type

- ※ Long Term Accelerated-Reliability test
LG's unique testing method with reinforced operating condition for a product life assurance to test and determine the product life cycle in a short period of time by accelerating the life cycle.
- ※ High Marginal Test
Test method to secure durability in various adverse conditions that may occur in the field by performing comp reliability test against higher pressure and temperature than the designed range of pressure and temperature which the comp operates in.
- ※ Verification obtained from TUV Rheinland for 10-year product life cycle.

Quick & Easy Installation

The machine's one-direction inlet and outlet piping and easy-to-connect wires in the junction box allow for quick and easy installation. Furthermore, the LG ThinQ app provides Service Alarm and Self Diagnosis programs for convenience maintenance.

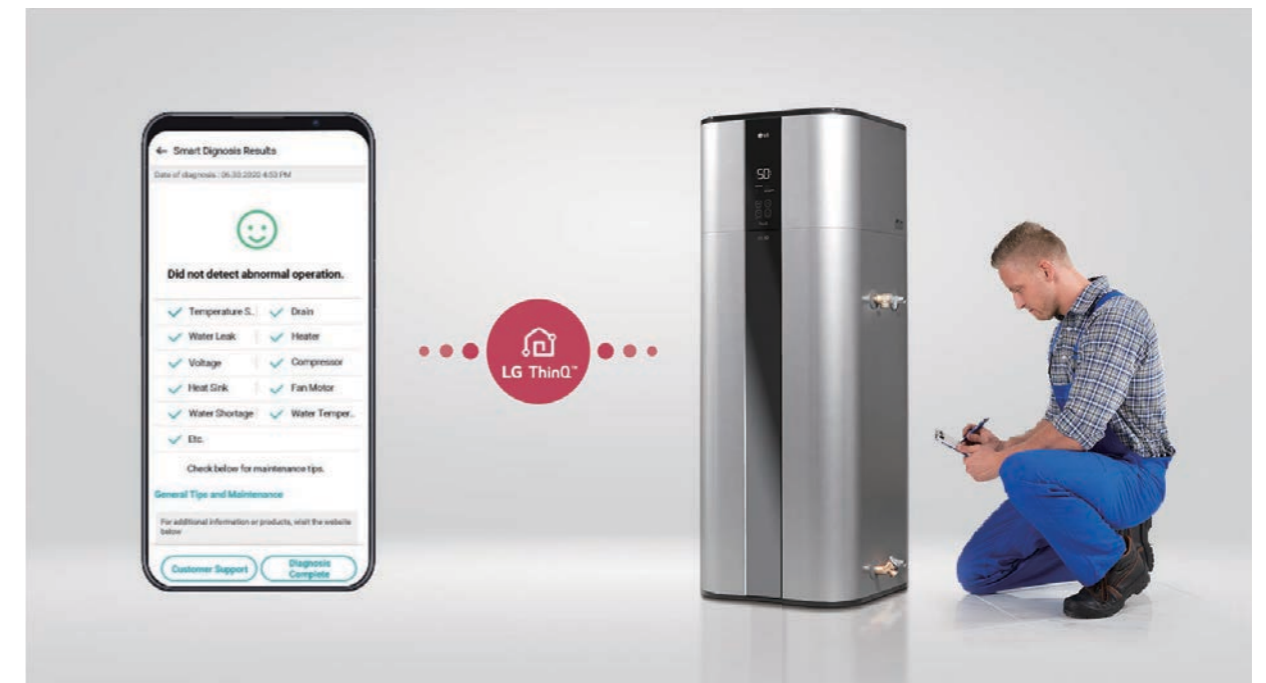

10 Year Warranty

10 year warranty for the core parts of the heat pump water heater - Water Tank, Compressor, TUV Rheinland certified 10 year durability of Dual Inverter Compressor. Ceramic coating inside water tank meets Germany Ceramic Standard DIN 4753 and it provides 10 years of corrosion resistance



※ Other Parts warranty may vary according to After Sales Service condition

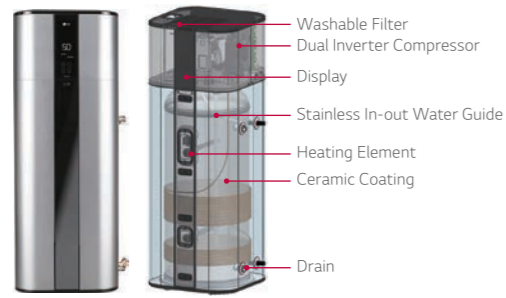

SALES MODEL		WH20S	
FACTORY MODEL		R5TT20F-SA1	
Capacity	Volume (Nominal)	200L	
Energy Efficiency ¹⁾	COP (7°C / 15°C)	3.30 / 3.50	
Energy Consumption	Annual Energy Consumption (7°C / 15°C)	kWh	756 / 709
Load Profile		Large	
Power Input	Upper Element Wattage (230V)	kW	2
	Lower Element Wattage (230V)	kW	2
Energy Efficiency Class (7°C / 15°C)		A+ / A+	
Power Supply	Ø, V, Hz	1 / 230 / 50	
Available Voltage Range	V	195 - 265	
Operating Mode		Turbo / Auto / HeatPump / Vacation	
Air Flow Rate	H / M	m ³ /min	6.7 / 4.4
	H / M	CFM	236.6 / 155.4
Sound Pressure Level	Auto	dB(A)+3	38
Sound Power Level		dB(A)	55
Dimensions	Net (W x H x D)	mm	580 x 1,625 x 582
Weight	Net	kg	100
Normal insulation thickness	Min. / Max.	mm	40 / 80
Heat Pump Operation Range	Min. / Max.	°C DB	-5 / 48
Exterior Color Code			Luxury Silver
Compressor	Type		Inverter Twin Rotary
	Warranty	Year	10
	Manufacturer		LG Electronics
	Motor Output	W	43
Design Pressure (System)	High Side		2.0MPa / 290 PSI
	Low Side		0.9MPa / 130.5 PSI
Max. Working Pressure (Water Tank)			150 PSI (1034 kPa)
Circuit Breaker		A	15
Condensate water connection	I.D	mm	19, 12.7
V40 (Mixed water at 40°C)		L	260
Refrigerant	Type		R134a
	Pre Charge	kg	0.650
	GWP		1,430
	t-CO ₂ eq		0.930
Defrost Method			Reverse Cycle
Anode			ICCP
T&P Relief Valve			Yes
Water Connection Location			side
Water Connection Size	inch		G ¾ M
Digital Display			Yes
Wi-Fi (LG ThinQ) ²⁾			Yes
Tank Warranty	Year		10

- 1) Water Heater Energy Efficiency (At Auto mode)
 2) ThinQ Main Function
 - Operation mode (Auto, Heatpump, Turbo, Vacation, Schedule), Temperature setting
 - Monitoring hot water Temperature
 - Maintenance point Alarm (Filter, Anode Rod, etc.)
 ※ This product contains Fluorinated greenhouse gases (R134a).
 ※ GWP : Global warming potential
 ※ t-CO₂eq : F-gas(kg)*GWP/1000
 ※ Specification, design and feature are subject to change without prior notice.



SALES MODEL		WH27S	
FACTORY MODEL		R5TT27F-SA0	
Capacity	Volume (Nominal)	270L	
Energy Efficiency ¹⁾	COP (7°C / 15°C)	3.45 / 3.85	
Energy Consumption	Annual Energy Consumption (7°C / 15°C)	kWh	712 / 646
Load Profile		Large	
Power Input	Upper Element Wattage (230V)	kW	2
	Lower Element Wattage (230V)	kW	2
Energy Efficiency Class (7°C / 15°C)		A+ / A++ ²⁾	
Power Supply	Ø, V, Hz	1 / 230 / 50	
Available Voltage Range	V	195 - 265	
Operating Mode		Turbo / Auto / HeatPump / Vacation	
Air Flow Rate	H / M	m ³ /min	6.7 / 4.4
	H / M	CFM	236.6 / 155.4
Sound Pressure Level	Auto	dB(A)+3	38
Sound Power Level		dB(A)	55
Dimensions	Net (W x H x D)	mm	580 x 2,008 x 582
Weight	Net	kg	119
Normal insulation thickness	Min. / Max.	mm	40 / 80
Heat Pump Operation Range	Min. / Max.	°C DB	-5 / 48
Exterior Color Code			Luxury Silver
Compressor	Type		Inverter Twin Rotary
	Warranty	Year	10
	Manufacturer		LG Electronics
	Motor Output	W	43
Design Pressure (System)	High Side		2.0MPa / 290 PSI
	Low Side		0.9MPa / 130.5 PSI
Max. Working Pressure (Water Tank)			150 PSI (1034 kPa)
Circuit Breaker		A	15
Condensate water connection	I.D	mm	19, 12.7
V40 (Mixed water at 40°C)		L	360
Refrigerant	Type		R134a
	Pre Charge	kg	0.750
	GWP		1,430
	t-CO ₂ eq		1.073
Defrost Method			Reverse Cycle
Anode			ICCP
T&P Relief Valve			Yes
Water Connection Location			side
Water Connection Size	inch		G ¾ M
Digital Display			Yes
Wi-Fi (LG ThinQ) ³⁾			Yes
Tank Warranty	Year		10

- 1) Water Heater Energy Efficiency (At Auto mode)
 2) Energy Label marked A+ and more than COP 3.75 in EU Standard is A++
 3) ThinQ Main Function
 - Operation mode (Auto, Heatpump, Turbo, Vacation, Schedule), Temperature setting
 - Monitoring hot water Temperature
 - Maintenance point Alarm (Filter, Anode Rod, etc.)
 ※ This product contains Fluorinated greenhouse gases (R134a).
 ※ GWP : Global warming potential
 ※ t-CO₂eq : F-gas(kg)*GWP/1000
 ※ Specification, design and feature are subject to change without prior notice.

MULTI SPLIT



R32 INDOOR / OUTDOOR UNITS

○ Single Only ● Multi Only ○● Compatible with Residential Single Split ○◎ Compatible with Commercial Single Split

kBtu/h	5	7	9	12	15	18	24
kW	1.5	2.1	2.6	3.5	4.2	5.3	7.0
ARTCOOL Gallery			●	●			
ARTCOOL Mirror		●	○●	○●		○●	○●
Air - Purification			○●	○●			
Deluxe		●	○●	○●		○●	○●
Standard Plus	●	●	○●	○●	●	○●	○●
Standard 2		●	○●	○●		○●	○●
1 Way Cassette			●	●			
4 Way Cassette	●	●	○◎	○◎		○◎	○◎
Mid / High Static Pressure						○◎	○◎
Low Static Pressure			○◎	○◎		○◎	○◎

kBtu/h	14	16	18	21	24	27	30
kW	4.1	4.7	5.3	6.2	7.0	7.9	8.8
Multi	MU2R15 ULO 2-port	MU2R17 ULO 2-port	MU3R19 U21 3-port	MU3R21 U21 3-port	MU4R25 U21 4-port	MU4R27 U40 4-port	MU5R30 U40 5-port

※ All indoor units are compatible with R410A outdoor units.

R410A INDOOR / OUTDOOR UNITS

kBtu/h	5	7	9	12	15	18	24
kW	1.5	2.1	2.6	3.5	4.2	5.3	7.0
Console			●	●		●	

kBtu/h	40	48	56
kW	11.7	14.1	16.4
Multi Piping	MU5M40 U44 5-port		
Distribution Box	FM40AH U34 / FM41AH U34 7-IDU	FM48AH U34 / FM49AH U34 8-IDU	FM56AH U34 / FM57AH U34 9-IDU

REFRIGERANT	R32							R410A			
	MULTI PIPING							DB BOX TYPE			
TYPE	14	16	18	21	24	27	30	40	40	48	56
kBtu/h	4.1	4.7	5.3	6.2	7.0	7.9	8.8	11.7	11.7	14.1	16.4
kW	4.1	4.7	5.3	6.2	7.0	7.9	8.8	11.7	11.7	14.1	16.4
BLDC Comp & Fan Motor	●	●	●	●	●	●	●	●	●	●	●
Eurovent Certification	●	●	●	●	●	●	●	●	●	●	●
Variable Voltage Control			●	●	●	●	●	●	●	●	●
Wide Louver Plus Fin	●	●	●	●	●	●	●	●	●	●	●
Optimized Heat Exchanger Path	●	●	●	●	●	●	●	●	●	●	●
Power Saving Start up			●	●	●	●	●	●	●	●	●
Peak Current Control	●	●	●	●	●	●	●	●	●	●	●
Standby Mode	●	●	●	●	●	●	●				
Mode Lock	●	●	●	●	●	●	●	●	●	●	●
R1 Compressor								●	●	●	●
Twin Rotary Compressor	●	●	●	●	●	●	●				
Smart Sensor Pressure Control			●	●	●	●	●	●	●	●	●
Black Fin Heat Exchanger	●	●	●	●	●	●	●	●	●	●	●
Fast Cooling & Heating			●	●	●	●	●	●	●	●	●
Night Silent Operation	●	●	●	●	●	●	●	●	●	●	●
Wiring Error Check	●	●	●	●	●	●	●	●	●	●	●
LG MV	●	●	●	●	●	●	●	●	●	●	●
PI-485 Connection			●	●	●	●	●	●	●	●	●
Forced Cooling Operation	●	●	●	●	●	●	●	●	●	●	●

KEY FEATURES

PERFECT SOLUTION FOR MULTIPLE ROOMS



Energy Efficiency | Extreme Durability | Comfort and Convenience

LG's Multi Split system provides powerful, efficient cooling and heating with two, three, four, or up to nine indoor units operating from a single outdoor unit. LG's advanced inverter technology offers powerful performance while consuming less energy and floor space than that of individual single split systems.



ENERGY EFFICIENCY A+++ / A+

The advanced technologies of LG achieve the lowest energy consumption, especially SEER value regarding ErP regulation.

World Class High Efficiency

SEER 8.5

SEER / SCOP class (ErP regulation)		4.1	4.7	5.3	6.2	7.0	7.9	8.8
SEER		8.5	7.8	8.5	8.5	8.0	8.0	8.2
		A+++	A++	A+++	A+++	A++	A++	A++
SCOP		4.2	4.2	4.4	4.4	4.4	4.4	4.2
		A+	A+	A+	A+	A+	A+	A+

- BLDC Inverter Twin Rotary Compressor
- Enhanced Heat Exchanger
- Smart Load Control
- Peak current control

Powerful Brushless Direct Current Motor (BLDC) Compressor

LG air conditioners are equipped with a BLDC Inverter Twin Rotary Compressor that uses a neodymium magnetic core. The compressor has high efficiency and superior reliability, because it is excellent in controlling the operating speed depending on the load. With improved efficiency as compared to standard AC inverter products, this compressor is optimized for outdoor load changes and seasonal efficiency.

Operation Range

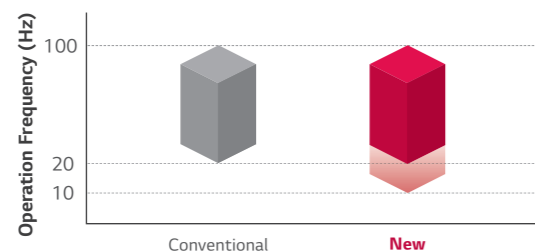

Motor Efficiency

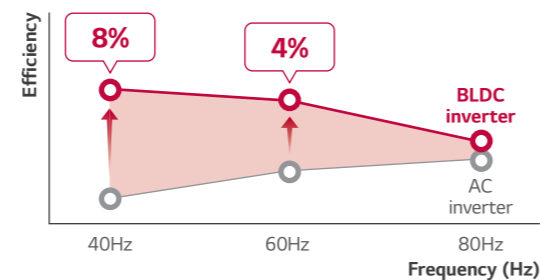

Enhanced Heat Exchange

Wide Louver Plus fin technology increases 11% of full load heating performance and 6% of COP compared to conventional fin. It can slow down frosting of heat exchanger and postpone the start of defrosting operation.

Heating Operation at Defrost Condition

It can slow down frosting of heat exchanger and postpone the start of defrosting operation.

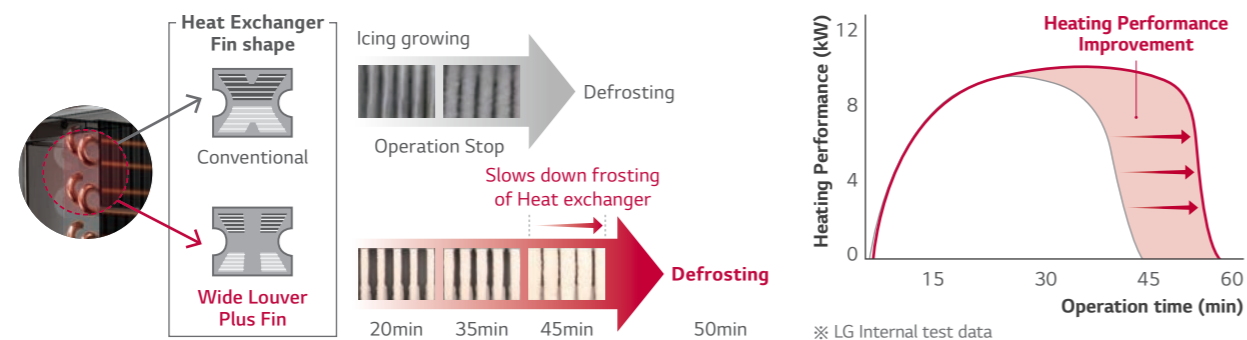

Power Saving Start Up

LG commercial air conditioners will automatically alter the temperature of discharge air by controlling their refrigerant temperature based on the difference between the indoor temperature and the target indoor temperature. During cooling operation, evaporating temperature will increase if the temperature difference reduces. This allows for enhanced comfort and reduced energy consumption.

Comfortable Indoor Air

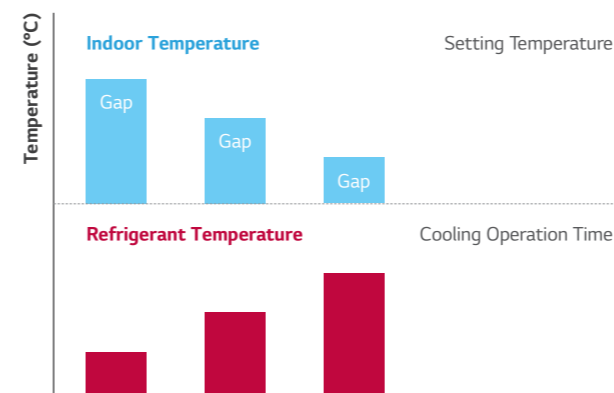

Energy Saving

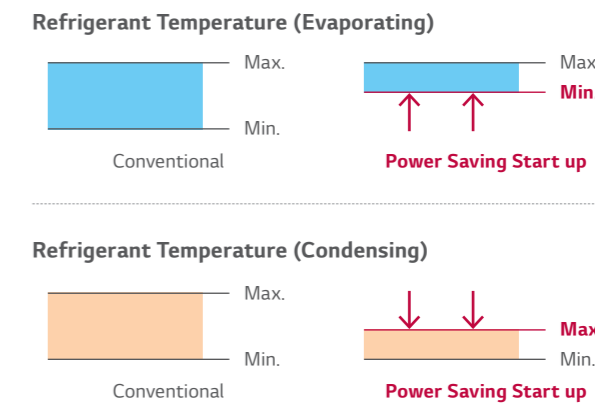

Mode Lock

Set the operation mode to either cooling-only or heating-only, either by adjusting the wired remote controller or setting the DIP switch to avoid combined use of cooling and heating. (Some models need wired remote controller for mode lock function according to feature overview table)

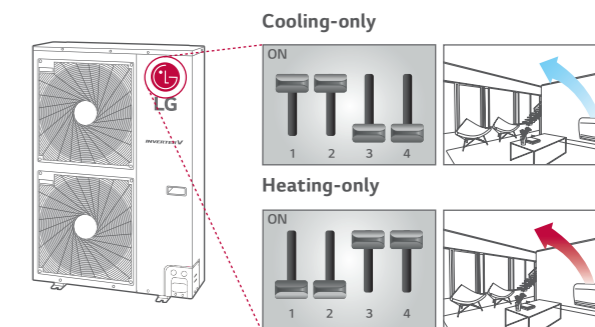

Peak Current Control

The peak current control function keeps the air conditioner from running at the maximum level while maintaining current system setting, in order to reduce energy consumption. This function allows for reduced energy costs during the peak energy use periods when energy fees are higher.

How to set dip switch

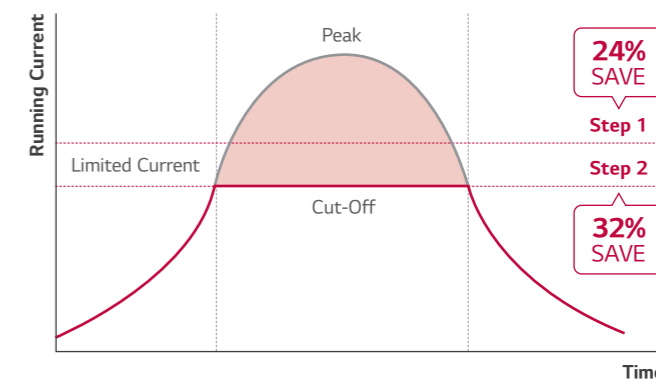
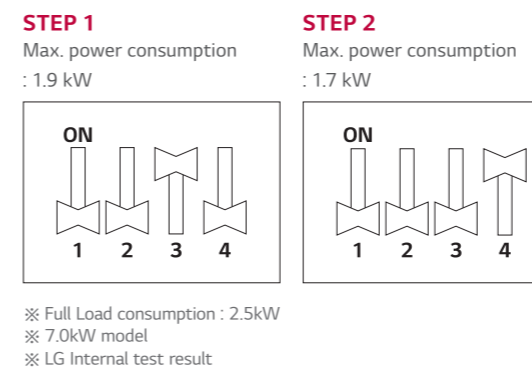

※ When using Peak current control, the cooling capacity may not be sufficient.
 ※ 7.0kW model ※ LG Internal test result



EXTREME DURABILITY

Product safety and Durability are assisted by advanced BLDC Inverter Twin Rotary compressor, Smart sensor, and Black Fin Heat Exchanger.

Improved BLDC Inverter Dual Inverter Compressor

Parts of BLDC Inverter Twin Rotary Compressor have been improved to allow a longer life span.

Flow Optimization

- Reduced oil inflow by increasing the length of oil discharge pipe, leading to a sufficient oil quantity inside compressor hence preventing compressor abrasion.

Concentrated Winding Motor

- Oil path area is improved by over 50% by increasing the extra stator cavity.
- Due to this, caloric value of motor is reduced, improving the cooling function of stator coil.

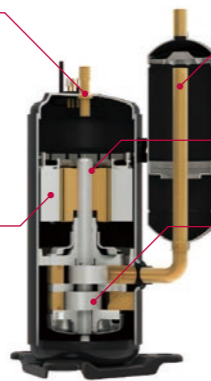

Twin Rotary Inverter Compressor

Suction Optimization

- Reduced suction loss and improving oil collection through the optimization of suction path.

Surface Coating

- Shaft coating and polishing has been improved.

Twin Rotary Rotor

- Upper and lower part rotor offset imbalance in shaft rotor rotation. Max. Torque has been decreased by 45% compared to single rotor.
- Vibration and noise are also reduced.

Pressure Control Technology by Smart Sensor

Quicker and more reliable operation made possible by pressure control technology.

Field Failure Rate of Outdoor Unit

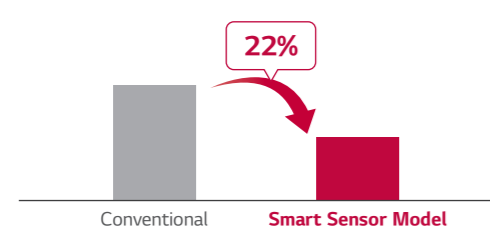

※ LG Internal result
※ FFR Period : 2 years before / after applying pressure sensor

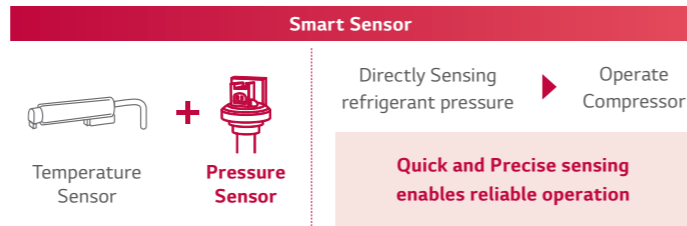

Corrosion Resistance Black Fin

The black coating with enhanced epoxy resin is applied for strong protection from various corrosive external conditions such as salt contamination and air pollution including fumes from factories.

Longer Lifespan, Lower Maintenance Costs

Hydrophilic Film (Water Flow)

The Hydrophilic coating minimizes moisture buildup on the fin.

Acryl + Epoxy + Melamine Resin (Corrosion Resistant)

The Black coating provides strong protection from corrosion.

Aluminum Fin

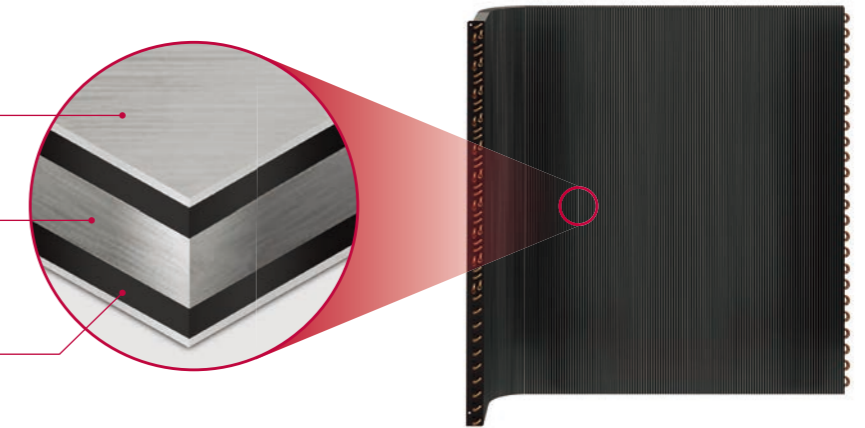

※ Product is not fully treated for anti-corrosion.
To install near the sea, additional treatment must be required.

SST (Salt Spray Test)

Test Process



Test process is conducted according to ISO 9227.
1) Salty water concentration : NaCl aqueous solution (5%)

Test Result (5% Area of defects compared to initial)

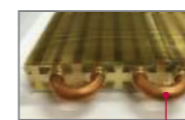
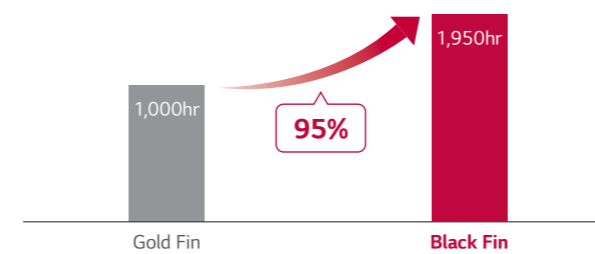

100% copper material to prevent corrosion & refrigerant leakage

CCT (Cyclic Corrosion Test)

Test Process

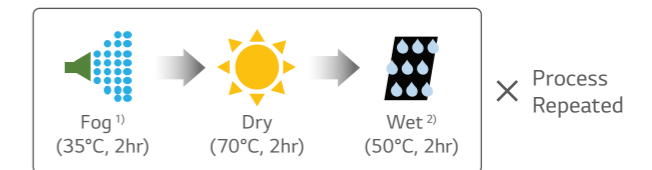

Test process is conducted according to ISO 14933.
1) Salty water concentration : NaCl aqueous solution (5%)
※ Dry condition changed : 60°C, 4hr → 70°C, 2hr
2) Deionized water

Test Result (5% Area of defects compared to initial)

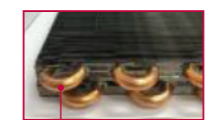
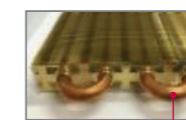
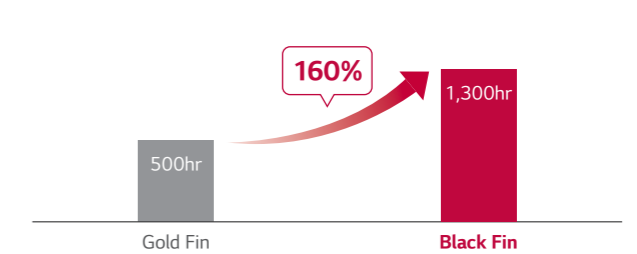

100% copper material to prevent corrosion & refrigerant leakage

R1 Compressor

Shaft-through Structure & Support both ends of shaft
- Solid compressor operation assuring higher durability

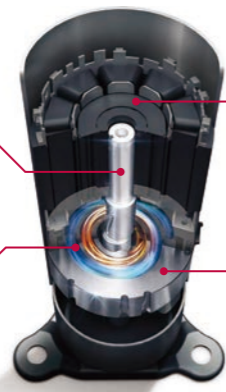

R1 Compressor™



Extended Operation Range (Max. 150Hz)
- Higher Heating Performance

Centrifugal oil return & Oil separating guide for oil discharge reduction
- Higher Energy Efficiency (*SEER 22% ↑)



Bottom Compression & Simple Structure
- Lower Noise & Vibration (**Max. 4dB(A) ↓)
- Less Weight (**20% ↓)
- Superior Reliability

* LG Internal test result, Based on single split 10 kW Cassette
** LG Internal test result, Based on conventional compressor (Rotary type GPT442M)
※ R1 Compressor application ※ Model : 40-56k (7 models)

Revolutionary Scroll Compressor

Revolutionary Scroll Compressor is applied for high-efficiency and reliability. This type of compressor is more advanced compared to the conventional one. Especially tilting motion of scroll has been improved. Further, the operation range is improved compared to the conventional type.

- Scroll compressor with simple structure
 - High efficiency (Low load at low speed / total efficiency)
 - Low noise (High speed possible)
 - Improved Tilting Motion of scroll
 - 20% weight reduction (vs. Conventional compressor)
- ※ Applied Model : 40-56k (7 models)

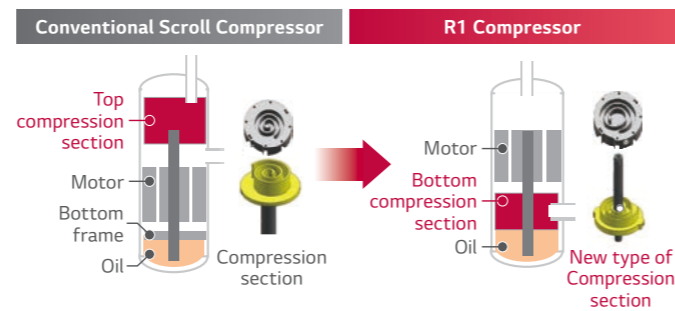

Seasonal energy efficiency

SEER 22%, SCOP 5% improvement (vs. Rotary)
※ Multi 40k

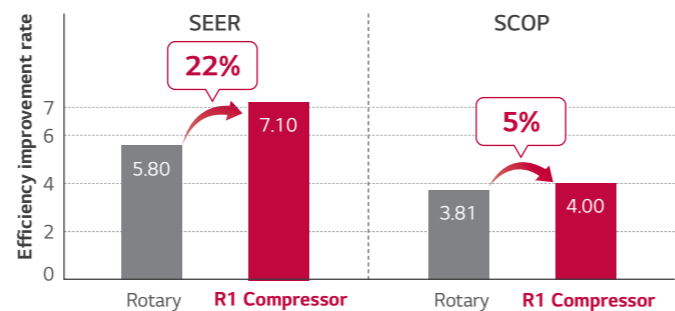

Wide Operation Range

- Optimized for various cooling & heat load operation
- World best compressor speed (Up to 150 Hz)
- Optimized for even low load operation (Down to 10 Hz) (Efficiency increases / Improved comfort)

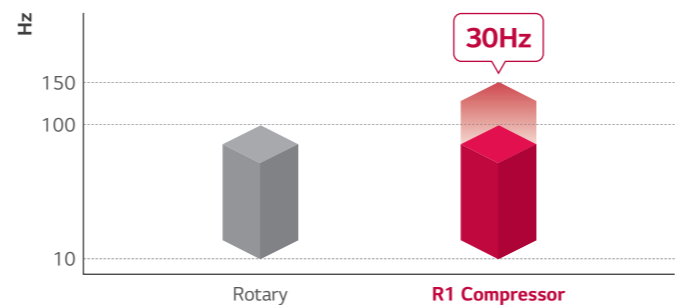

COMFORT & CONVENIENCE

The advanced technologies of LG achieve the lowest energy consumption, especially SEER value regarding ErP regulation.



- Fast cooling and heating
- Night Silent operation
- Easy installation and maintenance

Fast Cooling & Heating

Pressure control takes less time to reach the desired temperature up to 30% in cooling and 44% in heating with high level of accuracy and stability.

Cooling

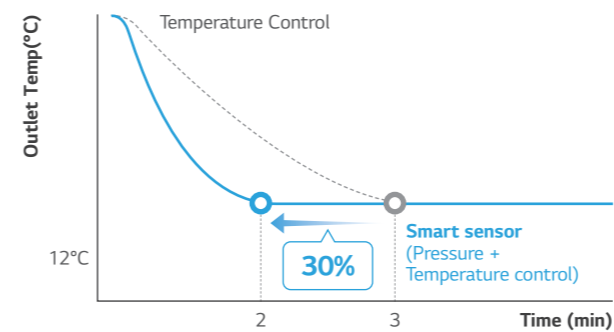

※ LG Internal test result

Heating

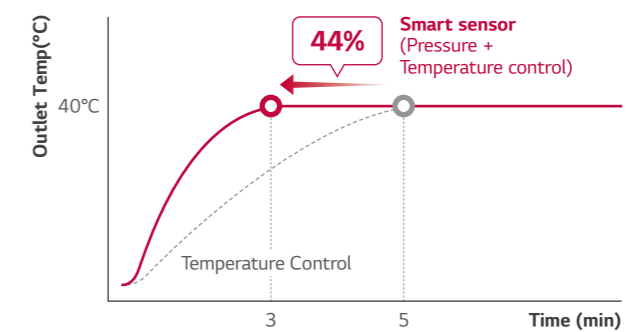

Night Silent Operation

Night Silent Operation can reduce noise levels at night time by simply setting the dip switch on the PCB of the outdoor unit.

Cooling Mode

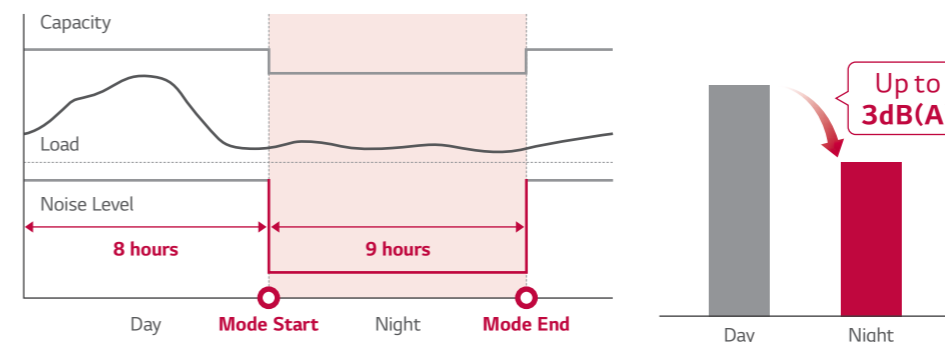

※ This function is only available for Cooling Mode.
※ If you want to stop the Night Quiet Mode, Change the Dip Switch.

Wiring Error Check

Installers can check whether the transmission cable has been connected correctly by using the wiring error check function. The wiring error check function can reduce the time taken to check for transmission cable errors.

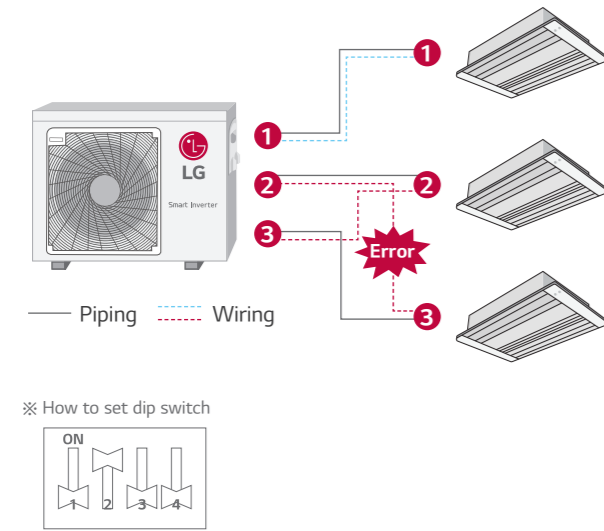

LED Result

- If the wiring is correct, the Green LED will light up.
- If the wiring is wrong, display as below.
 - Red LED : Piping Number
 - Green LED : Wiring Number (Room)

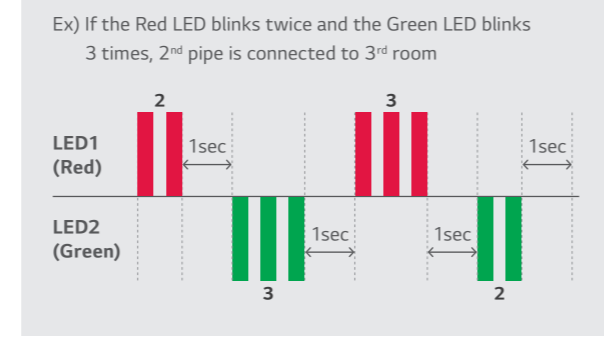

Advanced Grille & Fan

The improved grille shape design on the outdoor unit helps to distribute air more efficiently which improves heat exchange and reduces the noise level. The new axial Fan has a thick front edge and a smooth rear edge, thus providing not only high efficiency, low noise, wide fan, but also improving the air flow rate.

Grille

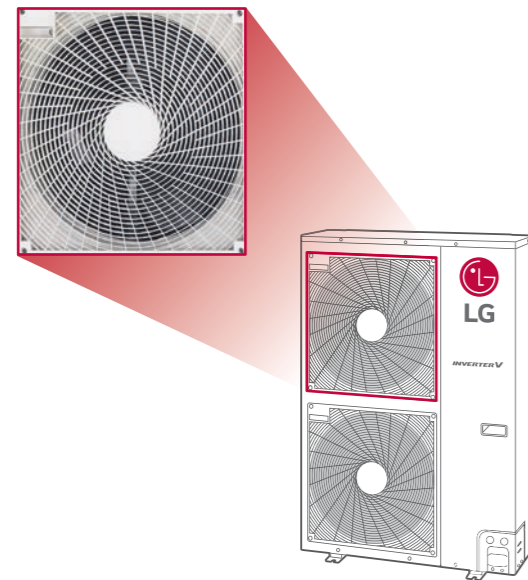

Fan Type 1

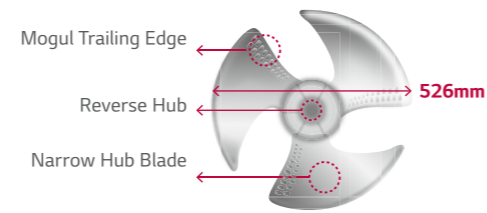

Fan Type 2

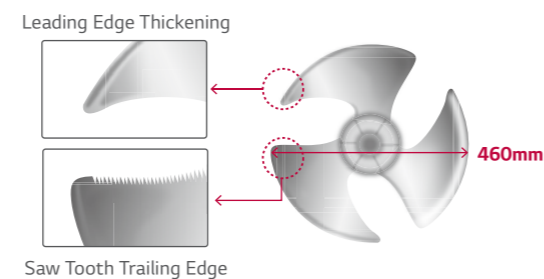

Forced Cooling Operation

The forced cooling operation allows refrigerant to be recharged or pumped down, regardless of the indoor temperature. More importantly this function can be used when indoor units are being moved or repaired.

Recharging

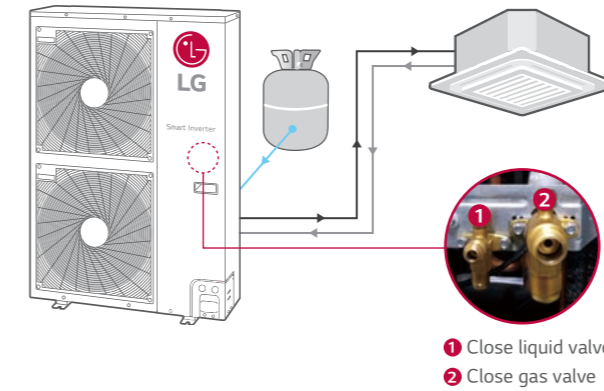

Pump Down

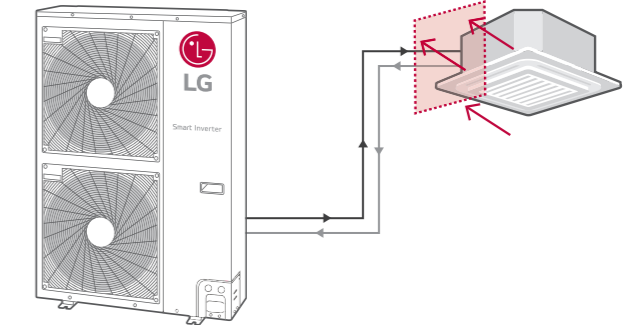

LG MV (Monitoring View)

LG MV helps engineers to inspect and monitor air conditioning units easily.

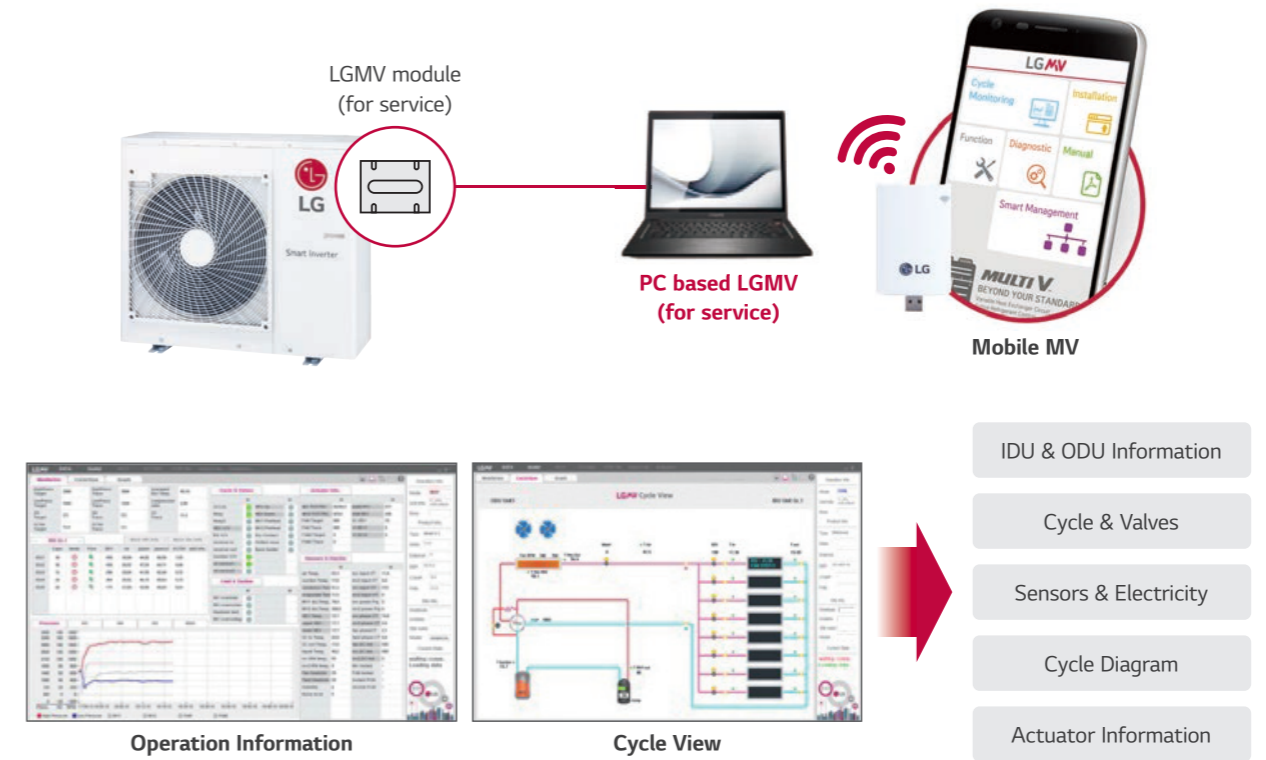

R32 MULTI SPLIT



LG participates in the ECP programme for EUROVENT VRF program. Check ongoing validity of certification : www.eurovent-certification.com

OUTDOOR UNITS				MU2R15 ULO	MU2R17 ULO
Compressor	Type			Twin Rotary	Twin Rotary
Capacity*	Cooling	Min. / Nom. / Max.	kW	0.9 / 4.1 / 4.7	0.9 / 4.7 / 5.4
	Heating	Min. / Nom. / Max.	kW	1.0 / 4.7 / 5.4	1.0 / 5.3 / 5.7
Low Temperature Capacity	Heating -7°C	Max.	kW	3.3	3.7
Power Input*	Cooling	Min. / Nom. / Max.	kW	0.2 / 1.0 / 1.4	0.2 / 1.3 / 1.7
	Heating	Min. / Nom. / Max.	kW	0.2 / 1.1 / 1.4	0.2 / 1.3 / 1.6
Running Current	Cooling	Min. / Nom. / Max.	A	1.1 / 4.6 / 6.4	1.1 / 5.6 / 7.9
	Heating	Min. / Nom. / Max.	A	1.1 / 4.9 / 6.6	1.1 / 5.5 / 7.6
EER				4.14	3.75
COP				4.38	4.22
SEER				8.50	7.80
SCOP				4.20	4.20
Pdesign (@-10°C)	kW			4.10	4.10
Seasonal Energy Label	Cooling / Heating (A+++ to D Scale)			A+++ / A+	A++ / A+
Annual Energy Consumption	Cooling / Heating			169 / 1,367	210 / 1,367
Airflow Rate	Nom.	m ³ /min		28.2	28.2
Sound Pressure	Cooling	Nom.	dB(A)	48	48
	Heating	Nom.	dB(A)	51	51
Sound Power	Cooling	Max.	dB(A)	61	63
Dimensions	W x H x D		mm	770 x 545 x 288	770 x 545 x 288
Net Weight				36	36
Refrigerant	Type			R32	R32
	Charge	Kg		1.1	1.1
	Additional Charge	g/m		20	20
	GWP			675	675
	t-CO ₂ eq			0.743	0.743
Operation Range (Outdoor)	Cooling	Min. / Max.	°C DB	-10 / 48	-10 / 48
	Heating	Min. / Max.	°C WB	-18 / 18	-18 / 18
Power Supply				Ø / V / Hz	1 / 220-240 / 50
Power Supply Cable				No. x mm ²	3C x 2.5
Transmission Cable				No. x mm ²	4C x 0.75
Circuit Breaker				A	15
Piping Length Total				m	30
Piping Length per Branch	Max.			m	20
Piping Elevation Difference	IDU - ODU	Max.	m	15	15
	IDU - IDU	Max.	m	7.5	7.5
Piping Connection	Liquid	mm (inch) x No.		Ø6.35 (1/4) x 2	Ø6.35 (1/4) x 2
	Gas	mm (inch) x No.		Ø9.52 (3/8) x 2	Ø9.52 (3/8) x 2

Notes :

- Capacities are based on the following conditions:
Cooling : - Indoor Temperature 27°C (80.6°F) DB / 19°C (66.2°F) WB - Outdoor Temperature 35°C (95°F) DB / 24°C (75.2°F) WB
Heating : - Indoor Temperature 20°C (68°F) DB / 15°C (59°F) WB - Outdoor Temperature 7°C (44.6°F) DB / 6°C (42.8°F) WB
Piping Length - Interconnecting Piping Length 7.5m - Level Difference of Zero.
- * : See page "Combination Table".
- Due to our policy of innovation some specifications may be changed without notification.
- At least two indoor units should be connected
- Minimum combination ratio should be more than 40%.
- This product contains fluorinated greenhouse gases (R32)



LG participates in the ECP programme for EUROVENT VRF program. Check ongoing validity of certification : www.eurovent-certification.com

OUTDOOR UNITS				MU3R19 U21	MU3R21 U21	MU4R25 U21
Compressor	Type			Twin Rotary	Twin Rotary	Twin Rotary
Capacity*	Cooling	Min. / Nom. / Max.	kW	1.1 / 5.3 / 6.3	1.1 / 6.2 / 7.3	1.1 / 7.0 / 8.5
	Heating	Min. / Nom. / Max.	kW	1.2 / 6.3 / 7.3	1.2 / 7.0 / 7.8	1.2 / 8.1 / 9.1
Low Temperature Capacity	Heating -7°C	Max.	kW	5.2	5.5	5.9
Power Input*	Cooling	Min. / Nom. / Max.	kW	0.3 / 1.1 / 2.0	0.3 / 1.4 / 2.5	0.3 / 1.8 / 2.8
	Heating	Min. / Nom. / Max.	kW	0.3 / 1.3 / 2.0	0.3 / 1.5 / 2.4	0.3 / 1.8 / 2.9
Running Current	Cooling	Min. / Nom. / Max.	A	1.3 / 5.0 / 9.2	1.3 / 6.5 / 11.1	1.3 / 8.0 / 12.6
	Heating	Min. / Nom. / Max.	A	1.3 / 5.7 / 9.2	1.3 / 6.9 / 10.8	1.3 / 8.3 / 12.9
EER				4.75	4.28	4.00
COP				5.00	4.60	4.40
SEER				8.50	8.50	8.00
SCOP				4.40	4.40	4.40
Pdesign (@-10°C)			kW	5.20	5.20	5.40
Seasonal Energy Label	Cooling / Heating (A+++ to D Scale)			A+++ / A+	A+++ / A+	A++ / A+
Annual Energy Consumption	Cooling / Heating			217 / 1,655	253 / 1,655	308 / 1,718
Airflow Rate	Nom.		m ³ /min	50	50	50
Sound Pressure	Cooling	Nom.	dB(A)	48	49	50
	Heating	Nom.	dB(A)	53	54	54
Sound Power	Cooling	Max.	dB(A)	63	64	66
Dimensions	W x H x D		mm	870 x 650 x 330	870 x 650 x 330	870 x 650 x 330
Net Weight			Kg	46	46	46.2
Refrigerant	Type			R32	R32	R32
	Charge		Kg	1.4	1.4	1.4
	Additional Charge		g/m	20	20	20
	GWP			675	675	675
	t-CO ₂ eq			0.945	0.945	0.945
Operation Range (Outdoor)	Cooling	Min. / Max.	°C DB	-10 / 48	-10 / 48	-10 / 48
	Heating	Min. / Max.	°C WB	-18 / 18	-18 / 18	-18 / 18
Power Supply			Ø / V / Hz	1 / 220-240 / 50	1 / 220-240 / 50	1 / 220-240 / 50
Power Supply Cable			No. x mm ²	3C x 2.5	3C x 2.5	3C x 2.5
Transmission Cable			No. x mm ²	4C x 0.75	4C x 0.75	4C x 0.75
Circuit Breaker			A	20	20	20
Piping Length Total			m	50	50	70
Piping Length per Branch		Max.	m	25	25	25
Piping Elevation Difference	IDU - ODU	Max.	m	15	15	15
	IDU - IDU	Max.	m	7.5	7.5	7.5
Piping Connection	Liquid		mm (inch) x No.	Ø6.35 (1/4) x 3	Ø6.35 (1/4) x 3	Ø6.35 (1/4) x 4
	Gas		mm (inch) x No.	Ø9.52 (3/8) x 3	Ø9.52 (3/8) x 3	Ø9.52 (3/8) x 4

Notes :

- Capacities are based on the following conditions:
Cooling : - Indoor Temperature 27°C (80.6°F) DB / 19°C (66.2°F) WB - Outdoor Temperature 35°C (95°F) DB / 24°C (75.2°F) WB
Heating : - Indoor Temperature 20°C (68°F) DB / 15°C (59°F) WB - Outdoor Temperature 7°C (44.6°F) DB / 6°C (42.8°F) WB
Piping Length - Interconnecting Piping Length 7.5m - Level Difference of Zero.
- *: See page "Combination Table".
- Due to our policy of innovation some specifications may be changed without notification.
- At least two indoor units should be connected
- Minimum combination ratio should be more than 40%.
- This product contains fluorinated greenhouse gases (R32)



LG participates in the ECP programme for EUROVENT VRF program. Check ongoing validity of certification : www.eurovent-certification.com

OUTDOOR UNITS				MU4R27 U40	MU5R30 U40
Compressor	Type			Twin Rotary	Twin Rotary
Capacity*	Cooling	Min. / Nom. / Max.	kW	1.3 / 7.9 / 9.5	1.3 / 8.8 / 10.6
	Heating	Min. / Nom. / Max.	kW	1.5 / 9.1 / 10.6	1.5 / 10.1 / 12.1
Low Temperature Capacity	Heating -7°C	Max.	kW	6.4	7.1
Power Input*	Cooling	Min. / Nom. / Max.	kW	0.4 / 1.8 / 2.9	0.4 / 2.0 / 3.4
	Heating	Min. / Nom. / Max.	kW	0.6 / 2.1 / 3.4	0.6 / 2.2 / 3.6
Running Current	Cooling	Min. / Nom. / Max.	A	1.9 / 8.1 / 13.1	1.9 / 9.1 / 15.2
	Heating	Min. / Nom. / Max.	A	2.8 / 9.4 / 15.3	2.8 / 9.7 / 16.3
EER				4.39	4.40
COP				4.39	4.70
SEER				8.00	8.20
SCOP				4.20	4.20
Pdesign (@-10°C)			kW	7.00	7.40
Seasonal Energy Label	Cooling / Heating (A+++ to D Scale)			A++ / A+	A++ / A+
Annual Energy Consumption	Cooling / Heating			346 / 2,333	376 / 2,467
Airflow Rate	Nom.		m ³ /min	60	60
Sound Pressure	Cooling	Nom.	dB(A)	50	50
	Heating	Nom.	dB(A)	54	54
Sound Power	Cooling	Max.	dB(A)	65	66
Dimensions	W x H x D		mm	950 x 834 x 330	950 x 834 x 330
Net Weight			Kg	61	61
Refrigerant	Type			R32	R32
	Charge		Kg	2.3	2.6
	Additional Charge		g/m	20	20
	GWP			675	675
	t-CO ₂ eq			1.553	1.755
Operation Range (Outdoor)	Cooling	Min. / Max.	°C DB	-10 / 48	-10 / 48
	Heating	Min. / Max.	°C WB	-18 / 18	-18 / 18
Power Supply			Ø / V / Hz	1 / 220-240 / 50	1 / 220-240 / 50
Power Supply Cable			No. x mm ²	3C x 2.5	3C x 2.5
Transmission Cable			No. x mm ²	4C x 0.75	4C x 0.75
Circuit Breaker			A	25	25
Piping Length Total			m	70	75
Piping Length per Branch		Max.	m	25	25
Piping Elevation Difference	IDU - ODU	Max.	m	15	15
	IDU - IDU	Max.	m	7.5	7.5
Piping Connection	Liquid		mm (inch) x No.	Ø6.35 (1/4) x 4	Ø6.35 (1/4) x 5
	Gas		mm (inch) x No.	Ø9.52 (3/8) x 4	Ø9.52 (3/8) x 5

Notes :

- Capacities are based on the following conditions:
Cooling : - Indoor Temperature 27°C (80.6°F) DB / 19°C (66.2°F) WB - Outdoor Temperature 35°C (95°F) DB / 24°C (75.2°F) WB
Heating : - Indoor Temperature 20°C (68°F) DB / 15°C (59°F) WB - Outdoor Temperature 7°C (44.6°F) DB / 6°C (42.8°F) WB
Piping Length - Interconnecting Piping Length 7.5m - Level Difference of Zero.
- *: See page "Combination Table".
- Due to our policy of innovation some specifications may be changed without notification.
- At least two indoor units should be connected
- Minimum combination ratio should be more than 40%.
- This product contains fluorinated greenhouse gases (R32)



LG participates in the ECP programme for EUROVENT VRF program. Check ongoing validity of certification : www.eurovent-certification.com

kBtu/H	5	7	9	12	15	18	24
kW	1.5	2.1	2.6	3.5	4.2	5.3	7.0
ARTCOOL Gallery	-	-	● MA09R NF1	● MA12R NF1	-	-	-

Single Combination

INDOOR				MA09R NF1	MA12R NF1
Capacity	Cooling	Rated	W	2,600	3,500
	Heating	Rated	W	2,900	3,900
Sound Pressure	Cooling	S / L / M / H	dB(A)	27 / 27 / 32 / 38	27 / 32 / 38 / 44
	Heating	L / M / H	dB(A)	27 / 32 / 38	32 / 38 / 44
Sound Power	Cooling	Power	dB(A)	52	54
Air Flow Rate	Cooling	S / L / M / H	m ³ /min	4.4 / 4.4 / 5.9 / 7.7	4.4 / 5.6 / 7.3 / 8.9
		Max. (Power)	m ³ /min	8.6	9.6
	Heating	L / M / H	m ³ /min	4.7 / 6.1 / 8.0	5.7 / 7.5 / 9.2
Dehumidification Rate			l/h	1.2	1.4
Power Supply			Ø / V / Hz	1 / 220-240 / 50	1 / 220-240 / 50
Power Supply Cable			N x mm ²	4C x 0.75	4C x 0.75
Dimension			mm	600 x 600 x 145	600 x 600 x 145
Net Weight			kg	15.0	15.0

※ This product contains Fluorinated greenhouse gases (R32).
 ※ S : Sleep / L : Low / M : Medium / H : High
 ※ GWP : Global warming potential
 ※ t-CO₂eq : F-gas(kg)*GWP/1000
 ※ For our policy of continuous product improvement, specification, design and feature are subject to change without prior notice.



LG participates in the ECP programme for EUROVENT VRF program. Check ongoing validity of certification : www.eurovent-certification.com

kBtu/H	5	7	9	12	15	18	24
kW	1.5	2.1	2.6	3.5	4.2	5.3	7.0
ARTCOOL Mirror	-	● AM07BH NSJ	● AC09BH NSJ	● AC12BH NSJ	-	● AC18BH NSK	● AC24BH NSK

Single Combination

INDOOR				AM07BH NSJ	AC09BH NSJ	AC12BH NSJ
Capacity	Cooling	Rated	W	2,100	2,500	3,500
	Heating	Rated	W	2,300	3,200	3,800
Sound Pressure	Cooling	S / L / M / H	dB(A)	19 / 26 / 32 / 36	19 / 26 / 33 / 38	19 / 26 / 35 / 39
	Heating	L / M / H	dB(A)	26 / 32 / 36	26 / 33 / 38	26 / 35 / 39
Sound Power	Cooling	Power	dB(A)	57	57	57
Air Flow Rate	Cooling	S / L / M / H	m ³ /min	3.0 / 5.0 / 7.2 / 8.6	3.0 / 5.0 / 7.6 / 9.1	3.0 / 5.0 / 8.1 / 9.6
		Max. (Power)	m ³ /min	11.1	11.1	11.1
	Heating	L / M / H	m ³ /min	5.0 / 7.2 / 8.6	5.0 / 7.6 / 9.1	5.0 / 8.1 / 9.6
Dehumidification Rate			l/h	0.9	1.1	1.2
Power Supply			Ø / V / Hz	1 / 220-240 / 50	1 / 220-240 / 50	1 / 220-240 / 50
Power Supply Cable			N x mm ²	4C x 0.75	4C x 0.75	4C x 0.75
Dimension			mm	837 x 308 x 192	837 x 308 x 192	837 x 308 x 192
Net Weight			kg	9.1	9.9	9.9

INDOOR				AC18BH NSK	AC24BH NSK
Capacity	Cooling	Rated	W	5,000	6,600
	Heating	Rated	W	5,800	7,500
Sound Pressure	Cooling	S / L / M / H	dB(A)	31 / 34 / 42 / 47	31 / 34 / 42 / 47
	Heating	L / M / H	dB(A)	34 / 42 / 47	34 / 42 / 47
Sound Power	Cooling	Power	dB(A)	59	65
Air Flow Rate	Cooling	S / L / M / H	m ³ /min	8.0 / 10.5 / 13.1 / 15.5	8.0 / 10.5 / 13.1 / 16.1
		Max. (Power)	m ³ /min	16.8	18.3
	Heating	L / M / H	m ³ /min	10.5 / 13.1 / 15.5	10.5 / 13.1 / 16.1
Dehumidification Rate			l/h	1.9	2.6
Power Supply			Ø / V / Hz	1 / 220-240 / 50	1 / 220-240 / 50
Power Supply Cable			N x mm ²	4C x 0.75	4C x 0.75
Dimension			mm	998 x 345 x 212	998 x 345 x 212
Net Weight			kg	12.8	13.5

※ This product contains Fluorinated greenhouse gases (R32).
 ※ S : Sleep / L : Low / M : Medium / H : High
 ※ GWP : Global warming potential
 ※ t-CO₂eq : F-gas(kg)*GWP/1000
 ※ For our policy of continuous product improvement, specification, design and feature are subject to change without prior notice.



LG participates in the ECP programme for EUROVENT VRF program. Check ongoing validity of certification : www.eurovent-certification.com

kBtu/H	5	7	9	12	15	18	24
kW	1.5	2.1	2.6	3.5	4.2	5.3	7.0
Air Purification	-	-	○● AP09RT NSJ	○● AP12RT NSJ	-	-	-

Single Combination

INDOOR				AP09RT NSJ	AP12RT NSJ
Capacity	Cooling	Rated	W	2,500	3,500
	Heating	Rated	W	3,300	4,000
Sound Pressure	Cooling	S / L / M / H	dB(A)	21 / 27 / 35 / 42	21 / 27 / 35 / 42
	Heating	L / M / H	dB(A)	27 / 35 / 42	27 / 35 / 42
Sound Power	Cooling	Power	dB(A)	59	59
Air Flow Rate	Cooling	S / L / M / H	m ³ /min	3.0 / 4.2 / 6.6 / 10.0	3.0 / 4.2 / 6.6 / 10.0
		Max. (Power)	m ³ /min	11.0	11.0
	Heating	L / M / H	m ³ /min	4.2 / 6.6 / 10.0	4.2 / 6.6 / 10.0
Dehumidification Rate			l/h	0.9	0.9
Power Supply			Ø / V / Hz	1 / 220-240 / 50	1 / 220-240 / 50
Power Supply Cable			N x mm ²	4C x 0.75	4C x 0.75
Dimension			mm	857 x 348 x 189	857 x 348 x 189
Net Weight			kg	9.5	9.5

※ This product contains Fluorinated greenhouse gases (R32).
 ※ S : Sleep / L : Low / M : Medium / H : High
 ※ GWP : Global warming potential
 ※ t-CO₂eq : F-gas(kg)*GWP/1000
 ※ For our policy of continuous product improvement, specification, design and feature are subject to change without prior notice.



LG participates in the ECP programme for EUROVENT VRF program. Check ongoing validity of certification : www.eurovent-certification.com

kBtu/H	5	7	9	12	15	18	24
kW	1.5	2.1	2.6	3.5	4.2	5.3	7.0
Deluxe	-	● DM07RH NSJ	○● DC09RH NSJ	○● DC12RH NSJ	-	○● DC18RH NSK	○● DC24RH NSK

Single Combination

INDOOR				DM07RH NSJ	DC09RH NSJ	DC12RH NSJ
Capacity	Cooling	Rated	W	2,100	2,500	3,500
	Heating	Rated	W	2,300	3,200	4,000
Sound Pressure	Cooling	S / L / M / H	dB(A)	19 / 27 / 31 / 36	19 / 27 / 32 / 36	19 / 29 / 34 / 38
	Heating	L / M / H	dB(A)	27 / 31 / 36	27 / 32 / 36	29 / 34 / 39
Sound Power	Cooling	Power	dB(A)	56	56	56
Air Flow Rate	Cooling	S / L / M / H	m ³ /min	3.5 / 5.0 / 6.1 / 7.4	3.5 / 5.0 / 6.4 / 7.7	3.5 / 5.3 / 6.7 / 8.1
		Max. (Power)	m ³ /min	10.1	10.1	10.1
	Heating	L / M / H	m ³ /min	5.0 / 6.1 / 7.4	5.0 / 6.4 / 7.7	5.3 / 6.7 / 8.1
Dehumidification Rate			l/h	0.9	1.1	1.2
Power Supply			Ø / V / Hz	1 / 220-240 / 50	1 / 220-240 / 50	1 / 220-240 / 50
Power Supply Cable			N x mm ²	4C x 0.75	4C x 0.75	4C x 0.75
Dimension			mm	837 x 308 x 189	837 x 308 x 189	837 x 308 x 189
Net Weight			kg	8.3	9.1	9.1

INDOOR				DC18RH NSK	DC24RH NSK
Capacity	Cooling	Rated	W	5,000	6,600
	Heating	Rated	W	5,800	7,500
Sound Pressure	Cooling	S / L / M / H	dB(A)	31 / 34 / 42 / 47	31 / 34 / 42 / 47
	Heating	L / M / H	dB(A)	34 / 42 / 47	34 / 42 / 47
Sound Power	Cooling	Power	dB(A)	60	64
Air Flow Rate	Cooling	S / L / M / H	m ³ /min	8.0 / 10.5 / 13.1 / 15.5	8.0 / 10.5 / 13.1 / 16.1
		Max. (Power)	m ³ /min	16.8	18.3
	Heating	L / M / H	m ³ /min	10.5 / 13.1 / 15.5	10.5 / 13.1 / 16.1
Dehumidification Rate			l/h	1.9	2.6
Power Supply			Ø / V / Hz	1 / 220-240 / 50	1 / 220-240 / 50
Power Supply Cable			N x mm ²	4C x 0.75	4C x 0.75
Dimension			mm	998 x 345 x 210	998 x 345 x 210
Net Weight			kg	11.9	12.7

※ This product contains Fluorinated greenhouse gases (R32).
 ※ S : Sleep / L : Low / M : Medium / H : High
 ※ GWP : Global warming potential
 ※ t-CO₂eq : F-gas(kg)*GWP/1000
 ※ For our policy of continuous product improvement, specification, design and feature are subject to change without prior notice.



LG participates in the ECP programme for EUROVENT VRF program. Check ongoing validity of certification : www.eurovent-certification.com

kBtu/H	5	7	9	12	15	18	24
kW	1.5	2.1	2.6	3.5	4.2	5.3	7.0
Standard Plus	● PM05SP NSA	● PM07SP NSA	●● PC09SQ NSJ	●● PC12SQ NSJ	● PM15SP NSJ	●● PC18SQ NSK	●● PC24SQ NSK

Single Combination

INDOOR				PM05SP NSA	PM07SP NSA	PC09SQ NSJ	PC12SQ NSJ	PM15SP NSJ
Capacity	Cooling	Rated	W	1,500	2,100	2,500	3,500	4,200
	Heating	Rated	W	1,600	2,300	3,200	3,800	5,400
Sound Pressure	Cooling	S / L / M / H	dB(A)	22 / 27 / 31 / 36	22 / 27 / 32 / 37	19 / 26 / 33 / 38	19 / 26 / 35 / 39	19 / 28 / 38 / 41
	Heating	L / M / H	dB(A)	25 / 29 / 35	25 / 31 / 37	26 / 33 / 38	26 / 35 / 39	28 / 38 / 41
Sound Power	Cooling	Power	dB(A)	57	57	57	57	57
Air Flow Rate	Cooling	S / L / M / H	m ³ /min	2.0 / 3.5 / 5.0 / 6.3	2.0 / 3.5 / 5.3 / 6.6	3.0 / 5.0 / 7.6 / 9.1	3.0 / 5.0 / 8.1 / 9.6	3.0 / 5.4 / 8.6 / 10.0
	Heating	L / M / H	m ³ /min	11.1	11.1	11.1	11.1	11.1
Dehumidification Rate			l/h	0.9	0.9	1.1	1.2	1.2
Power Supply			Ø / V / Hz	1 / 220-240 / 50	1 / 220-240 / 50	1 / 220-240 / 50	1 / 220-240 / 50	1 / 220-240 / 50
Power Supply Cable			N x mm ²	4C x 0.75	4C x 0.75	4C x 0.75	4C x 0.75	4C x 0.75
Dimension			mm	754 x 308 x 189	754 x 308 x 189	837 x 308 x 189	837 x 308 x 189	837 x 308 x 189
Net Weight			kg	7.8	7.8	8.7	8.7	8.7

INDOOR				PC18SQ NSK	PC24SQ NSK
Capacity	Cooling	Rated	W	5,000	6,600
	Heating	Rated	W	5,800	7,500
Sound Pressure	Cooling	S / L / M / H	dB(A)	31 / 34 / 42 / 47	31 / 34 / 42 / 47
	Heating	L / M / H	dB(A)	34 / 42 / 47	34 / 42 / 47
Sound Power	Cooling	Power	dB(A)	59	65
Air Flow Rate	Cooling	S / L / M / H	m ³ /min	8.0 / 10.5 / 13.1 / 15.5	8.0 / 10.5 / 13.1 / 16.1
	Heating	L / M / H	m ³ /min	16.8	18.3
Dehumidification Rate			l/h	1.9	2.6
Power Supply			Ø / V / Hz	1 / 220-240 / 50	1 / 220-240 / 50
Power Supply Cable			N x mm ²	4C x 0.75	4C x 0.75
Dimension			mm	998 x 345 x 210	998 x 345 x 210
Net Weight			kg	11.9	12.7

※ This product contains Fluorinated greenhouse gases (R32).
 ※ S : Sleep / L : Low / M : Medium / H : High
 ※ GWP : Global warming potential
 ※ t-CO₂eq : F-gas(kg)*GWP/1000
 ※ For our policy of continuous product improvement, specification, design and feature are subject to change without prior notice.



LG participates in the ECP programme for EUROVENT VRF program. Check ongoing validity of certification : www.eurovent-certification.com

kBtu/H	5	7	9	12	15	18	24
kW	1.5	2.1	2.6	3.5	4.2	5.3	7.0
Standard Plus	● MJ05PC NSJ	● MJ07PC NSJ	●● MJ09PC NSJ	●● MJ12PC NSJ	● MJ15PC NSJ	●● MJ18PC NSK	●● MJ24PC NSK

Single Combination

INDOOR				MJ05PC NSJ	MJ07PC NSJ	MJ09PC NSJ	MJ12PC NSJ	MJ15PC NSJ
Capacity	Cooling	Rated	W	1,500	2,100	2,500	3,500	4,200
	Heating	Rated	W	1,600	2,300	3,200	3,800	5,400
Sound Pressure	Cooling	S / L / M / H	dB(A)	19 / 27 / 30 / 35	19 / 27 / 31 / 36	19 / 27 / 32 / 36	19 / 29 / 34 / 38	19 / 29 / 35 / 40
	Heating	L / M / H	dB(A)	27 / 30 / 35	27 / 31 / 36	27 / 32 / 36	29 / 34 / 38	29 / 35 / 40
Sound Power	Cooling	Power	dB(A)	57	57	57	57	57
Air Flow Rate	Cooling	S / L / M / H	m ³ /min	3.5 / 5.0 / 5.8 / 7.1	3.5 / 5.0 / 6.1 / 7.4	3.5 / 5.0 / 6.4 / 7.7	3.5 / 5.3 / 6.7 / 8.1	3.5 / 5.4 / 7.0 / 8.7
	Heating	L / M / H	m ³ /min	10.1	10.1	10.1	10.1	10.1
Dehumidification Rate			l/h	0.9	0.9	1.1	1.2	1.2
Power Supply			Ø / V / Hz	1 / 220-240 / 50	1 / 220-240 / 50	1 / 220-240 / 50	1 / 220-240 / 50	1 / 220-240 / 50
Power Supply Cable			N x mm ²	4C x 0.75	4C x 0.75	4C x 0.75	4C x 0.75	4C x 0.75
Dimension			mm	837 x 308 x 189	837 x 308 x 189	837 x 308 x 189	837 x 308 x 189	837 x 308 x 189
Net Weight			kg	8.7	8.7	8.7	8.7	8.7

INDOOR				MJ18PC NSK	MJ24PC NSK
Capacity	Cooling	Rated	W	5,000	6,600
	Heating	Rated	W	5,800	7,500
Sound Pressure	Cooling	S / L / M / H	dB(A)	31 / 34 / 42 / 47	31 / 34 / 42 / 47
	Heating	L / M / H	dB(A)	34 / 42 / 47	34 / 42 / 47
Sound Power	Cooling	Power	dB(A)	59	65
Air Flow Rate	Cooling	S / L / M / H	m ³ /min	8.0 / 10.5 / 13.1 / 15.5	8.0 / 10.5 / 13.1 / 16.1
	Heating	L / M / H	m ³ /min	16.8	18.3
Dehumidification Rate			l/h	1.9	2.6
Power Supply			Ø / V / Hz	1 / 220-240 / 50	1 / 220-240 / 50
Power Supply Cable			N x mm ²	4C x 0.75	4C x 0.75
Dimension			mm	998 x 345 x 210	998 x 345 x 210
Net Weight			kg	12.0	12.0

※ This product contains Fluorinated greenhouse gases (R32).
 ※ S : Sleep / L : Low / M : Medium / H : High
 ※ GWP : Global warming potential
 ※ t-CO₂eq : F-gas(kg)*GWP/1000
 ※ For our policy of continuous product improvement, specification, design and feature are subject to change without prior notice.



LG participates in the ECP programme for EUROVENT VRF program. Check ongoing validity of certification : www.eurovent-certification.com

kBtu/H	5	7	9	12	15	18	24
kW	1.5	2.1	2.6	3.5	4.2	5.3	7.0
Standard2	-	● MS07ET NSA	○● S09ET NSJ	○● S12ET NSJ	-	○● S18ET NSK	○● S24ET NSK

Single Combination

INDOOR				MS07ET NSA	S09ET NSJ	S12ET NSJ
Capacity	Cooling	Rated	W	2,100	2,500	3,500
	Heating	Rated	W	2,300	3,200	3,800
Sound Pressure	Cooling	S / L / M / H	dB(A)	22 / 27 / 32 / 37	19 / 26 / 33 / 38	19 / 26 / 35 / 39
	Heating	L / M / H	dB(A)	25 / 31 / 37	26 / 33 / 38	26 / 35 / 39
Sound Power	Cooling	Power	dB(A)	57	57	57
Air Flow Rate	Cooling	S / L / M / H	m ³ /min	2.0 / 3.5 / 5.3 / 6.6	3.0 / 5.0 / 7.6 / 9.1	3.0 / 5.0 / 8.1 / 9.6
		Max. (Power)	m ³ /min	10.5	11.1	11.1
	Heating	L / M / H	m ³ /min	4.5 / 5.7 / 7.2	5.0 / 7.6 / 9.1	5.0 / 8.1 / 9.6
Dehumidification Rate			l/h	0.6	1.1	1.2
Power Supply			Ø / V / Hz	1 / 220-240 / 50	1 / 220-240 / 50	1 / 220-240 / 50
Power Supply Cable			N x mm ²	4C x 0.75	4C x 0.75	4C x 0.75
Dimension			mm	754 x 308 x 189	837 x 308 x 189	837 x 308 x 189
Net Weight			kg	7.8	8.7	8.7

INDOOR				S18ET NSK	S24ET NSK
Capacity	Cooling	Rated	W	5,000	6,600
	Heating	Rated	W	5,800	7,500
Sound Pressure	Cooling	S / L / M / H	dB(A)	31 / 34 / 42 / 47	31 / 34 / 42 / 47
	Heating	L / M / H	dB(A)	34 / 42 / 47	34 / 42 / 47
Sound Power	Cooling	Power	dB(A)	59	65
Air Flow Rate	Cooling	S / L / M / H	m ³ /min	8.0 / 10.5 / 13.1 / 15.5	8.0 / 10.5 / 13.1 / 16.1
		Max. (Power)	m ³ /min	16.8	18.3
	Heating	L / M / H	m ³ /min	10.5 / 13.1 / 15.5	10.5 / 13.1 / 16.1
Dehumidification Rate			l/h	1.9	2.6
Power Supply			Ø / V / Hz	1 / 220-240 / 50	1 / 220-240 / 50
Power Supply Cable			N x mm ²	4C x 0.75	4C x 0.75
Dimension			mm	998 x 345 x 210	998 x 345 x 210
Net Weight			kg	11.9	12.7

※ This product contains Fluorinated greenhouse gases (R32).
 ※ S : Sleep / L : Low / M : Medium / H : High
 ※ GWP : Global warming potential
 ※ t-CO₂eq : F-gas(kg)*GWP/1000
 ※ For our policy of continuous product improvement, specification, design and feature are subject to change without prior notice.



LG participates in the ECP programme for EUROVENT VRF program. Check ongoing validity of certification : www.eurovent-certification.com

kBtu/H	5	7	9	12	15	18	24
kW	1.5	2.1	2.6	3.5	4.2	5.3	7.0
1 Way Cassette	-	-	● MT09R NU1	● MT11R NU1	-	-	-

1 Way Cassette

INDOOR				MT09R NU1	MT11R NU1
Capacity	Cooling / Heating	Nom.	kW	2.6 / 2.9	3.5 / 3.9
Power Input		Nom.	W	20	20
Running Current		Nom.	A	0.2	0.2
Power Supply		Ø / V / Hz		1 / 220-240 / 50	1 / 220-240 / 50
Air Flow Rate		H / M / L	m ³ /min	7.5 / 7.3 / 6.8	8.1 / 7.4 / 7.0
Sound Pressure	Cooling	H / M / L	dB(A)	36 / 34 / 32	37 / 36 / 33
Sound Power	Cooling	Max.	dB(A)	54	57
Dehumidification Rate			l/h	1.1	1.2
Dimensions	Body	W x H x D	mm	860 x 132 x 450	860 x 132 x 450
Net Weight	Body		kg	13.5	13.5
Piping Connection	Liquid		mm (inch)	Ø6.35 (1/4)	Ø6.35 (1/4)
	Gas		mm (inch)	Ø9.52 (3/8)	Ø9.52 (3/8)
Decoration Panel	Model			PT-UAHW0 / PT-UAHGO / PT-UPHGO	PT-UAHW0 / PT-UAHGO / PT-UPHGO

※ This product contains Fluorinated greenhouse gases (R32).
 ※ For our policy of continuous product improvement, specification, design and features are subject to change without prior notice.

CEILING MOUNTED CASSETTE (4 WAY)



LG participates in the ECP programme for EUROVENT VRF program. Check ongoing validity of certification : www.eurovent-certification.com

kBtu/H	5	7	9	12	15	18	24
kW	1.5	2.1	2.6	3.5	4.2	5.3	7.0
4 Way Cassette	● MT06R NRO	● MT08R NRO	○○ CT09F NRO	○○ CT12F NRO	-	○○ CT18F NQO	○○ CT24F NBO

4 Way Cassette

INDOOR				MT06R NRO	MT08R NRO	CT09F NRO
Capacity	Cooling / Heating	Nom.	kW	1.5 / 1.6	2.1 / 2.3	2.6 / 2.9
Power Input		Nom.	W	20	20	22
Running Current		Nom.	A	0.40	0.40	0.40
Power Supply			Ø / V / Hz	1 / 220-240 / 50	1 / 220-240 / 50	1 / 220-240 / 50
Air Flow Rate		H / M / L	m³/min	7.5 / 6.0 / 5.0	7.5 / 6.0 / 5.0	8.5 / 7.0 / 6.0
Sound Pressure	Cooling	H / M / L	dB(A)	31 / 27 / 24	31 / 27 / 24	36 / 33 / 30
Sound Power	Cooling	Max.	dB(A)	48	48	52
Dehumidification Rate			l/h	-	-	0.9
Dimensions	Body	W x H x D	mm	570 x 214 x 570	570 x 214 x 570	570 x 214 x 570
Net Weight	Body		kg	11.7	11.7	12.4
Piping Connection	Liquid		mm (inch)	Ø6.35 (1/4)	Ø6.35 (1/4)	Ø6.35 (1/4)
	Gas		mm (inch)	Ø9.52 (3/8)	Ø9.52 (3/8)	Ø9.52 (3/8)
Decoration Panel	Model			PT-QCHW0	PT-QCHW0	PT-QAGW0
	Color			Morning Fog (9001)	Morning Fog (9001)	White (9003)
	Dimensions	W x H x D	mm	620 x 34 x 620	620 x 34 x 620	620 x 35 x 620
	Weight		kg	3	3	2.9

INDOOR				CT12F NRO	CT18F NQO	CT24F NBO
Capacity	Cooling / Heating	Nom.	kW	3.5 / 3.9	5.3 / 5.8	6.7 / 7.5
Power Input		Nom.	W	24	26	26
Running Current		Nom.	A	0.40	0.40	0.60
Power Supply			Ø / V / Hz	1 / 220-240 / 50	1 / 220-240 / 50	1 / 220-240 / 50
Air Flow Rate		H / M / L	m³/min	9.5 / 8.0 / 7.0	13.0 / 12.0 / 11.0	17.0 / 15.0 / 13.0
Sound Pressure	Cooling	H / M / L	dB(A)	38 / 35 / 32	41 / 39 / 39	38 / 36 / 34
Sound Power	Cooling	Max.	dB(A)	52	57	53
Dehumidification Rate			l/h	1.4	2.0	2.7
Dimensions	Body	W x H x D	mm	570 x 214 x 570	570 x 256 x 570	840 x 204 x 840
Net Weight	Body		kg	12.4	13.9	21.1
Piping Connection	Liquid		mm (inch)	Ø6.35 (1/4)	Ø6.35 (1/4)	Ø6.35 (1/4)
	Gas		mm (inch)	Ø9.52 (3/8)	Ø12.7 (1/2)	Ø12.7 (1/2)
Decoration Panel	Model			PT-QAGW0	PT-QAGW0	PT-AAGW0
	Color			White (9003)	White (9003)	White (9003)
	Dimensions	W x H x D	mm	620 x 35 x 620	620 x 35 x 620	950 x 35 x 950
	Weight		kg	2.9	2.9	7.1

※ Dual vane is applied to 24k
 ※ This product contains Fluorinated greenhouse gases (R32).
 ※ For our policy of continuous product improvement, specification, design and features are subject to change without prior notice.

CEILING CONCEALED DUCT

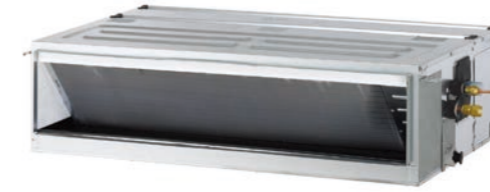

LG participates in the ECP programme for EUROVENT VRF program. Check ongoing validity of certification : www.eurovent-certification.com

kBtu/H	5	7	9	12	15	18	24
kW	1.5	2.1	2.6	3.5	4.2	5.3	7.0
Mid / High Static Pressure	-	-	-	-	-	○○ CM18F N10	○○ CM24F N10

Duct (Mid Static)

INDOOR				CM18F N10	CM24F N10
Capacity	Cooling / Heating	Nom.	kW	5.3 / 5.8	7.0 / 7.7
Power Input		H / M / L	W	150 / 130 / 110	180 / 150 / 130
Running Current		H / M / L	A	0.85 / 0.76 / 0.67	0.98 / 0.85 / 0.76
Power Supply			Ø / V / Hz	1 / 220-240 / 50	1 / 220-240 / 50
Air Flow Rate		H / M / L	m³/min	16.5 / 14.5 / 13.0	18.0 / 16.5 / 14.5
Sound Pressure		H / M / L	dB(A)	34 / 32 / 30	35 / 34 / 32
Sound Power Level		Rated	dB(A)	59	60
Dehumidification Rate			l/h	1.5	2.5
Dimensions		W x H x D	mm	900 x 270 x 700	900 x 270 x 700
Net Weight			kg	24.6	24.6
Piping Connections	Liquid Side		mm (inch)	Ø6.35 (1/4)	Ø9.52 (3/8)
	Gas Side		mm (inch)	Ø12.7 (1/2)	Ø15.88 (5/8)
External static pressure	Min. - Max.		Pa (mmAq)	58.8 (6)	58.8 (6)



LG participates in the ECP programme for EUROVENT VRF program. Check ongoing validity of certification : www.eurovent-certification.com

kBtu/H	5	7	9	12	15	18	24
kW	1.5	2.1	2.6	3.5	4.2	5.3	7.0
Low Static Pressure	-	-	○○ CL09F N50	○○ CL12F N50	-	○○ CL18F N60	-

Duct (Low Static)

INDOOR				CL09F N50	CL12F N50	CL18F N60
Capacity	Cooling / Heating	Nom.	kW	2.5 / 3.2	3.4 / 4.0	5.0 / 5.8
Power Input		H / M / L	W	21 / 15 / 13	21 / 15 / 13	100 / 90 / 80
Running Current		H / M / L	A	0.21 / 0.16 / 0.14	0.21 / 0.16 / 0.14	0.43 / 0.39 / 0.34
Power Supply			Ø / V / Hz	1 / 220-240 / 50	1 / 220-240 / 50	1 / 220-240 / 50
Air Flow Rate		H / M / L	m³/min	11.5 / 9.5 / 8.0	11.5 / 9.5 / 8.0	15.0 / 12.0 / 10.0
Sound Pressure		H / M / L	dB(A)	35 / 30 / 27	35 / 30 / 27	34 / 31 / 29
Sound Power Level		Rated	dB(A)	55	55	56
Dehumidification Rate			l/h	0.5	0.9	1.7
Dimensions		W x H x D	mm	900 x 190 x 460	900 x 190 x 460	1,100 x 190 x 460
Net Weight			kg	18.0	18.0	20.9
Piping Connections	Liquid Side		mm (inch)	Ø 6.35 (1/4)	Ø 6.35 (1/4)	Ø 6.35 (1/4)
	Gas Side		mm (inch)	Ø 9.52 (3/8)	Ø 9.52 (3/8)	Ø 12.7 (1/2)
External static pressure	Min. - Max.		Pa (mmAq)	0 - 5 (0 - 50)	0 - 5 (0 - 50)	0 - 5 (0 - 50)

※ This product contains Fluorinated greenhouse gases (R32).
 ※ For our policy of continuous product improvement, specification, design and features are subject to change without prior notice.



LG participates in the ECP programme for EUROVENT VRF program. Check ongoing validity of certification : www.eurovent-certification.com

kBtu/H	5	7	9	12	15	18	24
kW	1.5	2.1	2.6	3.5	4.2	5.3	7.0
Low Static Pressure	-	-	-	-	-	-	○○ CL24F N30

Duct (Low Static)

INDOOR				CL24F N30
Capacity	Cooling / Heating	Nom.	kW	6.8 / 7.5
Power Input		H / M / L	W	150 / 130 / 110
Running Current		H / M / L	A	0.65 / 0.56 / 0.47
Power Supply			Ø / V / Hz	1 / 220-240 / 50
Air Flow Rate		H / M / L	m³/min	20.0 / 16.0 / 12.0
Sound Pressure		H / M / L	dB(A)	39 / 35 / 32
Sound Power Level		Rated	dB(A)	58
Dehumidification Rate			l/h	2.5
Dimensions		W x H x D	mm	1,100 x 190 x 700
Net Weight			kg	26.0
Piping Connections	Liquid Side		mm (inch)	Ø 9.52 (3/8)
	Gas Side		mm (inch)	Ø 15.88 (5/8)
External static pressure	Min. - Max.		Pa (mmAq)	0 - 5 (0 - 50)



MU2R15

COOLING															
OPERATION	COMBINATION OF INDOOR UNIT (kBtu/h CLASS)					TOTAL CAPACITY						INPUT(W)			
						MIN.		RATED		MAX.					
	UNIT-A	UNIT-B	UNIT-C	UNIT-D	TOTAL	Btu/h	kW	Btu/h	kW	Btu/h	kW	MIN.	RATED	MAX.	
1 UNIT	5					5	3,000	0.88	5,000	1.47	5,750	1.69	226	381	477
	7					7	4,200	1.23	7,000	2.05	8,050	2.36	303	540	683
	9					9	5,400	1.58	9,000	2.64	10,350	3.03	408	676	864
	12					12	7,200	2.11	12,000	3.52	13,800	4.04	540	926	1,176
2 UNIT	5 5					10	6,000	1.76	10,000	2.93	11,500	3.37	414	682	889
	5 7					12	7,200	2.11	12,000	3.52	13,800	4.04	486	833	1,106
	5 9					14	8,400	2.46	14,000	4.10	16,100	4.72	583	988	1,376
	7 7					14	8,400	2.46	14,000	4.10	16,100	4.72	583	988	1,376
	7 9					16	8,400	2.46	14,000	4.10	16,100	4.72	583	988	1,376
	5 12					17	8,400	2.46	14,000	4.10	16,100	4.72	583	988	1,376
	9 9					18	8,400	2.46	14,000	4.10	16,100	4.72	583	988	1,376
	7 12					19	8,400	2.46	14,000	4.10	16,100	4.72	583	988	1,376
9 12					21	8,400	2.46	14,000	4.10	16,100	4.72	583	988	1,376	

HEATING															
OPERATION	COMBINATION OF INDOOR UNIT (kBtu/h CLASS)					TOTAL CAPACITY						INPUT(W)			
						MIN.		RATED		MAX.					
	UNIT-A	UNIT-B	UNIT-C	UNIT-D	TOTAL	Btu/h	kW	Btu/h	kW	Btu/h	kW	MIN.	RATED	MAX.	
1 UNIT	5					5	3,300	0.97	5,500	1.61	6,050	1.77	235	380	472
	7					7	5,040	1.48	8,400	2.46	9,240	2.71	355	604	721
	9					9	6,480	1.90	10,800	3.17	11,880	3.48	454	784	949
	12					12	7,920	2.32	13,200	3.87	14,520	4.26	554	969	1,185
2 UNIT	5 5					10	6,600	1.93	11,000	3.22	12,100	3.55	408	706	854
	5 7					12	7,920	2.32	13,200	3.87	14,520	4.26	498	872	1,066
	5 9					14	9,600	2.81	16,000	4.69	18,400	5.39	613	1,066	1,433
	7 7					14	9,600	2.81	16,000	4.69	18,400	5.39	613	1,066	1,433
	7 9					16	9,600	2.81	16,000	4.69	18,400	5.39	613	1,066	1,433
	5 12					17	9,600	2.81	16,000	4.69	18,400	5.39	613	1,066	1,433
	9 9					18	9,600	2.81	16,000	4.69	18,400	5.39	613	1,066	1,433
	7 12					19	9,600	2.81	16,000	4.69	18,400	5.39	613	1,066	1,433
9 12					21	9,600	2.81	16,000	4.69	18,400	5.39	613	1,066	1,433	

※ For our policy of continuous product improvement, specification, design and features are subject to change without prior notice.



MU2R17

COOLING															
OPERATION	COMBINATION OF INDOOR UNIT (kBtu/h CLASS)					TOTAL CAPACITY						INPUT(W)			
						MIN.		RATED		MAX.					
	UNIT-A	UNIT-B	UNIT-C	UNIT-D	TOTAL	Btu/h	kW	Btu/h	kW	Btu/h	kW	MIN.	RATED	MAX.	
1 UNIT	5					5	3,000	0.88	5,000	1.47	5,750	1.69	226	381	477
	7					7	4,200	1.23	7,000	2.05	8,050	2.36	303	540	683
	9					9	5,400	1.58	9,000	2.64	10,350	3.03	408	676	864
	12					12	7,200	2.11	12,000	3.52	13,800	4.04	540	926	1,176
	15					15	8,520	2.50	14,200	4.16	16,330	4.79	648	1,196	1,588
2 UNIT	5 5					10	6,000	1.76	10,000	2.93	11,500	3.37	414	682	889
	5 7					12	7,200	2.11	12,000	3.52	13,800	4.04	486	833	1,058
	5 9					14	8,400	2.46	14,000	4.10	16,100	4.72	583	988	1,376
	7 7					14	8,400	2.46	14,000	4.10	16,100	4.72	583	988	1,376
	7 9					16	9,600	2.81	16,000	4.69	18,400	5.39	657	1,251	1,699
	5 12					17	9,600	2.81	16,000	4.69	18,400	5.39	657	1,251	1,699
	9 9					18	9,600	2.81	16,000	4.69	18,400	5.39	657	1,251	1,699
	7 12					19	9,600	2.81	16,000	4.69	18,400	5.39	657	1,251	1,699
	5 15					20	9,600	2.81	16,000	4.69	18,400	5.39	657	1,251	1,699
	9 12					21	9,600	2.81	16,000	4.69	18,400	5.39	657	1,251	1,699
	7 15					22	9,600	2.81	16,000	4.69	18,400	5.39	657	1,251	1,699
	9 15					24	9,600	2.81	16,000	4.69	18,400	5.39	657	1,251	1,699
12 12					24	9,600	2.81	16,000	4.69	18,400	5.39	657	1,251	1,699	

HEATING															
OPERATION	COMBINATION OF INDOOR UNIT (kBtu/h CLASS)					TOTAL CAPACITY						INPUT(W)			
						MIN.		RATED		MAX.					
	UNIT-A	UNIT-B	UNIT-C	UNIT-D	TOTAL	Btu/h	kW	Btu/h	kW	Btu/h	kW	MIN.	RATED	MAX.	
1 UNIT	5					5	3,300	0.97	5,500	1.61	6,050	1.77	235	380	472
	7					7	5,040	1.48	8,400	2.46	9,240	2.71	355	604	721
	9					9	6,480	1.90	10,800	3.17	11,880	3.48	454	758	920
	12					12	7,920	2.32	13,200	3.87	14,520	4.26	554	942	1,155
	15					15	9,900	2.90	16,500	4.84	18,150	5.32	706	1,187	1,489
2 UNIT	5 5					10	6,600	1.93	11,000	3.22	12,100	3.55	408	706	854
	5 7					12	7,920	2.32	13,200	3.87	14,520	4.26	498	872	1,066
	5 9					14	9,600	2.81	16,000	4.69	18,400	5.39	613	1,066	1,433
	7 7					14	9,600	2.81	16,000	4.69	18,400	5.39	613	1,066	1,433
	7 9					16	10,800	3.17	18,000	5.28	19,400	5.69	706	1,247	1,633
	5 12					17	10,800	3.17	18,000	5.28	19,400	5.69	706	1,247	1,633
	9 9					18	10,800	3.17	18,000	5.28	19,400	5.69	706	1,247	1,633
	7 12					19	10,800	3.17	18,000	5.28	19,400	5.69	706	1,247	1,633
	5 15					20	10,800	3.17	18,000	5.28	19,400	5.69	706	1,247	1,633
	9 12					21	10,800	3.17	18,000	5.28	19,400	5.69	706	1,247	1,633
	7 15					22	10,800	3.17	18,000	5.28	19,400	5.69	706	1,247	1,633
	9 15					24	10,800	3.17	18,000	5.28	19,400	5.69	706	1,247	1,633
12 12					24	10,800	3.17	18,000	5.28	19,400	5.69	706	1,247	1,633	

※ For our policy of continuous product improvement, specification, design and features are subject to change without prior notice.



MU3R19

OPERATION	COMBINATION OF INDOOR UNIT (kBtu/h CLASS)				COOLING						INPUT(W)			
					TOTAL CAPACITY		MIN.		RATED					MAX.
	UNIT-A	UNIT-B	UNIT-C	UNIT-D	TOTAL	Btu/h	kW	Btu/h	kW	Btu/h	kW	MIN.	RATED	MAX.
1 UNIT	5				5	3,600	1.06	5,000	1.47	6,000	1.76	288	363	571
	7				7	4,200	1.23	7,000	2.05	8,400	2.46	319	478	645
	9				9	5,400	1.58	9,000	2.64	10,800	3.17	378	595	847
	12				12	7,200	2.11	12,000	3.52	14,400	4.22	478	822	1,139
	15				15	8,520	2.50	15,000	4.40	17,040	4.99	573	1,003	1,356
	18				18	10,800	3.17	18,000	5.28	21,600	6.33	747	1,302	1,827
2 UNIT	5	5			10	7,200	2.11	10,000	2.93	12,000	3.52	350	532	788
	5	7			12	7,200	2.11	12,000	3.52	14,400	4.22	350	669	991
	5	9			14	8,400	2.46	14,000	4.10	16,800	4.92	408	821	1,215
	7	7			14	8,400	2.46	14,000	4.10	16,800	4.92	408	821	1,215
	7	9			16	9,600	2.81	16,000	4.69	19,200	5.63	469	991	1,467
	5	12			17	10,200	2.99	17,000	4.98	20,400	5.98	532	1,083	1,603
	9	9			18	10,800	3.17	18,000	5.28	21,600	6.33	599	1,182	2,040
	7	12			19	10,800	3.17	18,000	5.28	21,600	6.33	599	1,182	2,040
	5	15			20	10,800	3.17	18,000	5.28	21,600	6.33	599	1,182	2,040
	9	12			21	10,800	3.17	18,000	5.28	21,600	6.33	599	1,182	2,040
	7	15			22	10,800	3.17	18,000	5.28	21,600	6.33	599	1,182	2,040
	5	18			23	10,800	3.17	18,000	5.28	21,600	6.33	599	1,182	2,040
	9	15			24	10,800	3.17	18,000	5.28	21,600	6.33	599	1,182	2,040
	12	12			24	10,800	3.17	18,000	5.28	21,600	6.33	599	1,182	2,040
	7	18			25	10,800	3.17	18,000	5.28	21,600	6.33	599	1,182	2,040
	9	18			27	10,800	3.17	18,000	5.28	21,600	6.33	599	1,182	2,040
	12	15			27	10,800	3.17	18,000	5.28	21,600	6.33	599	1,182	2,040
	5	24			29	10,800	3.17	18,000	5.28	21,600	6.33	599	1,182	2,040
12	18			30	10,800	3.17	18,000	5.28	21,600	6.33	599	1,182	2,040	
15	15			30	10,800	3.17	18,000	5.28	21,600	6.33	599	1,182	2,040	
3 UNIT	5	5	5		15	9,000	2.64	15,000	4.40	18,000	5.28	422	837	1,239
	5	5	7		17	10,200	2.99	17,000	4.98	20,400	5.98	481	1,013	1,500
	5	5	9		19	10,800	3.17	18,000	5.28	21,600	6.33	544	1,111	1,918
	5	7	7		19	10,800	3.17	18,000	5.28	21,600	6.33	544	1,111	1,918
	5	7	9		21	10,800	3.17	18,000	5.28	21,600	6.33	544	1,111	1,918
	7	7	7		21	10,800	3.17	18,000	5.28	21,600	6.33	544	1,111	1,918
	5	5	12		22	10,800	3.17	18,000	5.28	21,600	6.33	544	1,111	1,918
	5	9	9		23	10,800	3.17	18,000	5.28	21,600	6.33	544	1,111	1,918
	7	7	9		23	10,800	3.17	18,000	5.28	21,600	6.33	544	1,111	1,918
	5	7	12		24	10,800	3.17	18,000	5.28	21,600	6.33	544	1,111	1,918
	5	5	15		25	10,800	3.17	18,000	5.28	21,600	6.33	544	1,111	1,918
	7	9	9		25	10,800	3.17	18,000	5.28	21,600	6.33	544	1,111	1,918
	5	9	12		26	10,800	3.17	18,000	5.28	21,600	6.33	544	1,111	1,918
	7	7	12		26	10,800	3.17	18,000	5.28	21,600	6.33	544	1,111	1,918
	5	7	15		27	10,800	3.17	18,000	5.28	21,600	6.33	544	1,111	1,918
	9	9	9		27	10,800	3.17	18,000	5.28	21,600	6.33	544	1,111	1,918
	7	9	12		28	10,800	3.17	18,000	5.28	21,600	6.33	544	1,111	1,918
	5	5	18		28	10,800	3.17	18,000	5.28	21,600	6.33	544	1,111	1,918
	5	9	15		29	10,800	3.17	18,000	5.28	21,600	6.33	544	1,111	1,918
	5	12	12		29	10,800	3.17	18,000	5.28	21,600	6.33	544	1,111	1,918
	7	7	15		29	10,800	3.17	18,000	5.28	21,600	6.33	544	1,111	1,918
	5	7	18		30	10,800	3.17	18,000	5.28	21,600	6.33	544	1,111	1,918
	9	9	12		30	10,800	3.17	18,000	5.28	21,600	6.33	544	1,111	1,918

※ For our policy of continuous product improvement, specification, design and features are subject to change without prior notice.



MU3R19

OPERATION	COMBINATION OF INDOOR UNIT (kBtu/h CLASS)				HEATING						INPUT(W)			
					TOTAL CAPACITY		MIN.		RATED					MAX.
	UNIT-A	UNIT-B	UNIT-C	UNIT-D	TOTAL	Btu/h	kW	Btu/h	kW	Btu/h	kW	MIN.	RATED	MAX.
1 UNIT	5				5	4,000	1.17	5,500	1.61	6,325	1.85	279	384	589
	7				7	5,040	1.48	8,400	2.46	9,660	2.83	342	579	743
	9				9	6,480	1.90	10,800	3.17	12,420	3.64	483	757	997
	12				12	7,920	2.32	13,200	3.87	15,180	4.45	537	954	1,234
	15				15	9,900	2.90	16,500	4.84	18,975	5.56	688	1,189	1,593
	18				18	11,880	3.48	19,800	5.80	22,770	6.67	845	1,483	1,978
2 UNIT	5	5			10	7,200	2.11	12,000	3.52	14,400	4.22	329	598	861
	5	7			12	8,640	2.53	14,400	4.22	17,280	5.06	430	904	1,301
	5	9			14	10,080	2.95	16,800	4.92	20,160	5.91	484	945	1,360
	7	7			14	10,080	2.95	16,800	4.92	20,160	5.91	484	945	1,360
	7	9			16	11,520	3.38	19,200	5.63	23,040	6.75	540	1,118	1,610
	5	12			17	12,240	3.59	20,400	5.98	24,480	7.17	598	1,319	1,899
	9	9			18	12,960	3.80	21,600	6.33	25,000	7.33	660	1,391	2,040
	7	12			19	12,960	3.80	21,600	6.33	25,000	7.33	660	1,391	2,040
	5	15			20	12,960	3.80	21,600	6.33	25,000	7.33	660	1,391	2,040
	9	12			21	12,960	3.80	21,600	6.33	25,000	7.33	660	1,391	2,040
	7	15			22	12,960	3.80	21,600	6.33	25,000	7.33	660	1,391	2,040
	5	18			23	12,960	3.80	21,600	6.33	25,000	7.33	660	1,391	2,040
	9	15			24	12,960	3.80	21,600	6.33	25,000	7.33	660	1,391	2,040
	12	12			24	12,960	3.80	21,600	6.33	25,000	7.33	660	1,391	2,040
	7	18			25	12,960	3.80	21,600	6.33	25,000	7.33	660	1,391	2,040
	9	18			27	12,960	3.80	21,600	6.33	25,000	7.33	660	1,391	2,040
	12	15			27	12,960	3.80	21,600	6.33	25,000	7.33	660	1,391	2,040
	5	24			29	12,960	3.80	21,600	6.33	25,000	7.33	660	1,391	2,040
12	18			30	12,960	3.80	21,600	6.33	25,000	7.33	660	1,391	2,040	
15	15			30	12,960	3.80	21,600	6.33	25,000	7.33	660	1,391	2,040	
3 UNIT	5	5	5		15	18,000	5.28	21,600	6.33	25,000	7.33	725	1,266	1,823
	5	5	7		17	22,400	6.59	20,400	5.98	24,480	7.17	551	1,118	1,610
	5	5	9		19	12,960	3.80	21,600	6.33	25,000	7.33	725	1,266	1,823
	5	7	7		19	12,960	3.80	21,600	6.33	25,000	7.33	725	1,266	1,823
	5	7	9		21	12,960	3.80	21,600	6.33	25,000	7.33	725	1,266	1,823
	7	7	7		21	12,960	3.80	21,600	6.33	25,000	7.33	725	1,266	1,823
	5	5	12		22	12,960	3.80	21,600	6.33	25,000	7.33	725	1,266	1,823
	5	9	9		23	12,960	3.80	21,600	6.33	25,000	7.33	725	1,266	1,823
	7	7	9		23	12,960	3.80	21,600	6.33	25,000	7.33	725	1,266	1,823
	5	7	12		24	12,960	3.80	21,600	6.33	25,000	7.33	725	1,266	1,823
	5	5	15		25	12,960	3.80	21,600	6.33	25,000	7.33	725	1,266	1,823
	7	9	9		25	12,960	3.80	21,600	6.33	25,000	7.33	725	1,266	1,823
	5	9	12		26	12,960	3.80	21,600	6.33	25,000	7.33	725	1,266	1,823
	7	7	12		26	12,960	3.80	21,600	6.33	25,000	7.33	725	1,266	1,823
	5	7	15		27	12,960	3.80	21,600	6.33	25,000	7.33	725	1,266	1,823
	9	9	9		27	12,960	3.80	21,600	6.33	25,000	7.33	725	1,266	1,823
	7	9	12		28	12,960	3.80	21,600	6.33	25,000	7.33	725	1,266	1,823
	5	5	18		28	12,960	3.80	21,600	6.33	25,000	7.33	725	1,266	1,823
	5	9	15		29	12,960	3.80	21,600	6.33	25,000	7.33	725	1,266	1,823
	5	12	12		29	12,960	3.80	21,600	6.33	25,000	7.33	725	1,266	1,823
	7	7												



MU3R21

OPERATION	COOLING													
	COMBINATION OF INDOOR UNIT (kBtu/h CLASS)					TOTAL CAPACITY						INPUT(W)		
						MIN.		RATED		MAX.				
UNIT-A	UNIT-B	UNIT-C	UNIT-D	TOTAL	Btu/h	kW	Btu/h	kW	Btu/h	kW	MIN.	RATED	MAX.	
1 UNIT		5			5	3,600	1.06	5,000	1.47	6,000	1.76	288	363	571
		7			7	4,200	1.23	7,000	2.05	8,400	2.46	319	478	645
		9			9	5,400	1.58	9,000	2.64	10,800	3.17	378	595	847
		12			12	7,200	2.11	12,000	3.52	14,400	4.22	478	822	1,139
		15			15	8,520	2.50	15,000	4.40	17,040	4.99	573	1,003	1,356
		18			18	10,800	3.17	18,000	5.28	21,600	6.33	747	1,302	1,827
2 UNIT		5	5		10	7,200	2.11	10,000	2.93	12,000	3.52	350	532	788
		5	7		12	7,200	2.11	12,000	3.52	14,400	4.22	350	669	991
		5	9		14	8,400	2.46	14,000	4.10	16,800	4.92	408	821	1,215
		7	7		14	8,400	2.46	14,000	4.10	16,800	4.92	408	821	1,215
		7	9		16	9,600	2.81	16,000	4.69	19,200	5.63	469	991	1,467
		5	12		17	10,200	2.99	17,000	4.98	20,400	5.98	532	1,083	1,603
		9	9		18	10,800	3.17	18,000	5.28	21,600	6.33	599	1,182	1,890
		7	12		19	11,400	3.34	19,000	5.57	22,800	6.68	669	1,290	2,064
		5	15		20	12,000	3.52	20,000	5.86	24,000	7.03	669	1,406	2,249
		9	12		21	12,600	3.69	21,000	6.15	24,150	7.08	743	1,530	2,450
		7	15		22	12,600	3.69	21,000	6.15	24,150	7.08	743	1,530	2,450
		5	18		23	12,600	3.69	21,000	6.15	24,150	7.08	743	1,530	2,450
		9	15		24	12,600	3.69	21,000	6.15	25,000	7.33	743	1,530	2,450
		12	12		24	12,600	3.69	21,000	6.15	25,000	7.33	743	1,530	2,450
		7	18		25	12,600	3.69	21,000	6.15	25,000	7.33	743	1,530	2,450
		9	18		27	12,600	3.69	21,000	6.15	25,000	7.33	743	1,530	2,450
		12	15		27	12,600	3.69	21,000	6.15	25,000	7.33	743	1,530	2,450
		5	24		29	12,600	3.69	21,000	6.15	25,000	7.33	743	1,530	2,450
		12	18		30	12,600	3.69	21,000	6.15	25,000	7.33	743	1,530	2,450
		15	15		30	12,600	3.69	21,000	6.15	25,000	7.33	743	1,530	2,450
	7	24		31	12,600	3.69	21,000	6.15	25,000	7.33	743	1,530	2,450	
	9	24		33	12,600	3.69	21,000	6.15	25,000	7.33	743	1,530	2,450	
	15	18		33	12,600	3.69	21,000	6.15	25,000	7.33	743	1,530	2,450	
3 UNIT		5	5	5	15	9,000	2.64	15,000	4.40	18,000	5.28	422	837	1,239
		5	5	7	17	10,200	2.99	17,000	4.98	20,400	5.98	481	1,013	1,500
		5	5	9	19	11,400	3.34	19,000	5.57	22,800	6.68	544	1,212	1,940
		5	7	7	19	11,400	3.34	19,000	5.57	22,800	6.68	544	1,212	1,940
		5	7	9	21	12,600	3.69	21,000	6.15	25,000	7.33	682	1,438	2,301
		7	7	7	21	12,600	3.69	21,000	6.15	25,000	7.33	682	1,438	2,301
		5	5	12	22	12,600	3.69	21,000	6.15	25,000	7.33	682	1,438	2,301
		5	9	9	23	12,600	3.69	21,000	6.15	25,000	7.33	682	1,438	2,301
		7	7	9	23	12,600	3.69	21,000	6.15	25,000	7.33	682	1,438	2,301
		5	7	12	24	12,600	3.69	21,000	6.15	25,000	7.33	682	1,438	2,301
		5	5	15	25	12,600	3.69	21,000	6.15	25,000	7.33	682	1,438	2,301
		7	9	9	25	12,600	3.69	21,000	6.15	25,000	7.33	682	1,438	2,301
		5	9	12	26	12,600	3.69	21,000	6.15	25,000	7.33	682	1,438	2,301
		7	7	12	26	12,600	3.69	21,000	6.15	25,000	7.33	682	1,438	2,301
		5	7	15	27	12,600	3.69	21,000	6.15	25,000	7.33	682	1,438	2,301
		9	9	9	27	12,600	3.69	21,000	6.15	25,000	7.33	682	1,438	2,301
		7	9	12	28	12,600	3.69	21,000	6.15	25,000	7.33	682	1,438	2,301
		5	5	18	28	12,600	3.69	21,000	6.15	25,000	7.33	682	1,438	2,301
		5	9	15	29	12,600	3.69	21,000	6.15	25,000	7.33	682	1,438	2,301
		5	12	12	29	12,600	3.69	21,000	6.15	25,000	7.33	682	1,438	2,301
		7	7	15	29	12,600	3.69	21,000	6.15	25,000	7.33	682	1,438	2,301
		5	7	18	30	12,600	3.69	21,000	6.15	25,000	7.33	682	1,438	2,301
		9	9	12	30	12,600	3.69	21,000	6.15	25,000	7.33	682	1,438	2,301
		7	9	15	31	12,600	3.69	21,000	6.15	25,000	7.33	682	1,438	2,301
		7	12	12	31	12,600	3.69	21,000	6.15	25,000	7.33	682	1,438	2,301
		5	12	15	32	12,600	3.69	21,000	6.15	25,000	7.33	682	1,438	2,301
		5	9	18	32	12,600	3.69	21,000	6.15	25,000	7.33	682	1,438	2,301
		7	7	18	32	12,600	3.69	21,000	6.15	25,000	7.33	682	1,438	2,301
		9	9	15	33	12,600	3.69	21,000	6.15	25,000	7.33	682	1,438	2,301
		9	12	12	33	12,600	3.69	21,000	6.15	25,000	7.33	682	1,438	2,301

※ For our policy of continuous product improvement, specification, design and features are subject to change without prior notice.



MU3R21

OPERATION	HEATING													
	COMBINATION OF INDOOR UNIT (kBtu/h CLASS)					TOTAL CAPACITY						INPUT(W)		
						MIN.		RATED		MAX.				
UNIT-A	UNIT-B	UNIT-C	UNIT-D	TOTAL	Btu/h	kW	Btu/h	kW	Btu/h	kW	MIN.	RATED	MAX.	
1 UNIT		5			5	4,000	1.17	5,500	1.61	6,325	1.85	279	384	589
		7			7	5,040	1.48	8,400	2.46	9,660	2.83	342	579	743
		9			9	6,480	1.90	10,800	3.17	12,420	3.64	483	757	997
		12			12	7,920	2.32	13,200	3.87	15,180	4.45	537	954	1,234
		15			15	9,900	2.90	16,500	4.84	18,975	5.56	688	1,189	1,593
		18			18	11,880	3.48	19,800	5.80	22,770	6.67	845	1,483	1,978
2 UNIT		5	5		10	7,200	2.11	12,000	3.52	14,400	4.22	329	598	861
		5	7		12	8,640	2.53	14,400	4.22	17,280	5.06	430	904	1,301
		5	9		14	10,080	2.95	16,800	4.92	20,160	5.91	484	945	1,360
		7	7		14	10,080	2.95	16,800	4.92	20,160	5.91	484	945	1,360
		7	9		16	11,520	3.38	19,200	5.63	23,040	6.75	540	1,118	1,610
		5	12		17	12,240	3.59	20,400	5.98	24,480	7.17	598	1,319	1,899
		9	9		18	12,960	3.80	21,600	6.33	25,920	7.60	660	1,430	2,059
		7	12		19	13,680	4.01	22,800	6.68	26,600	7.80	725	1,543	2,221
		5	15		20	14,400	4.22	24,000	7.03	26,600	7.80	764	1,662	2,380
		9	12		21	14,400	4.22	24,000	7.03	26,600	7.80	764	1,662	2,380
		7	15		22	14,400	4.22	24,000	7.03	26,600	7.80	764	1,662	2,380
		5	18		23	14,400	4.22	24,000	7.03	26,600	7.80	764	1,662	2,380
		9	15		24	14,400	4.22	24,000	7.03	26,600	7.80	764	1,662	2,380
		12	12		24	14,400	4.22	24,000	7.03	26,600	7.80	764	1,662	2,380
		7	18		25	14,400	4.22	24,000	7.03	26,600	7.80	764	1,662	2,380
		9	18		27	14,400	4.22	24,000	7.03	26,600	7.80	764	1,662	2,380
		12	15		27	14,400	4.22	24,000	7.03	26,600	7.80	764	1,662	2,380
		5	24		29	14,400	4.22	24,000	7.03	26,600	7.80	764	1,662	2,380
		12	18		30	14,400	4.22	24,000	7.03	26,600	7.80	764	1,662	2,380
		15	15		30	14,400	4.22	24,000	7.03	26,600	7.80	764	1,662	2,380
	7	24		31	14,400	4.22	24,000	7.03	26,600	7.80	764	1,662	2,380	
	9	24		33	14,400	4.22	24,000	7.03	26,600	7.80	764	1,662	2,380	
	15	18		33	14,400	4.22	24,000	7.03	26,600	7.80	764	1,662	2,380	
3 UNIT		5	5	5	15	10,800	3.17	18,000	5.28	21,600	6.33	497	946	1,363
		5	5	7	17	12,240	3.59	20,400	5.98	24,480	7.17	551	1,118	1,610
		5	5	9	19	13,680	4.01	22,800	6.68	26,600	7.80	725	1,419	2,044
		5	7	7	19	13,680	4.01	22,800	6.68	26,600	7.80	725	1,419	2,044
		5	7	9	21	14,400	4.22	24,000	7.03	26,600	7.80	730	1,529	2,202
		7	7	7	21	14,400	4.22	24,000	7.03	26,600	7.80	730	1,529	2,202
		5	5	12	22	14,400	4.22	24,000	7.03	26,600	7.80	730	1,529	2,202



MU4R25

OPERATION	COOLING														
	COMBINATION OF INDOOR UNIT (kBtu/h CLASS)					TOTAL CAPACITY						INPUT(W)			
	UNIT-A	UNIT-B	UNIT-C	UNIT-D	TOTAL	MIN.		RATED		MAX.		MIN.	RATED	MAX.	
1 UNIT	5				5	3,600	1.06	5,000	1.47	6,000	1.76	288	363	571	
	7				7	4,200	1.23	7,000	2.05	8,400	2.46	319	478	645	
	9				9	5,400	1.58	9,000	2.64	10,800	3.17	378	595	847	
	12				12	7,200	2.11	12,000	3.52	14,400	4.22	478	822	1,139	
	15				15	8,520	2.50	15,000	4.40	17,040	4.99	573	1,003	1,356	
	18				18	10,800	3.17	18,000	5.28	21,600	6.33	747	1,302	1,827	
	5	5			10	7,200	2.11	10,000	2.93	12,000	3.52	350	532	788	
	5	7			12	7,200	2.11	12,000	3.52	14,400	4.22	350	669	991	
	5	9			14	8,400	2.46	14,000	4.10	16,800	4.92	408	821	1,215	
	7	7			14	8,400	2.46	14,000	4.10	16,800	4.92	408	821	1,215	
2 UNIT	7	9			16	9,600	2.81	16,000	4.69	19,200	5.63	469	991	1,467	
	5	12			17	10,200	2.99	17,000	4.98	20,400	5.98	532	1,083	1,603	
	9	9			18	10,800	3.17	18,000	5.28	21,600	6.33	599	1,182	1,749	
	7	12			19	11,400	3.34	19,000	5.57	22,800	6.68	669	1,290	1,909	
	5	15			20	12,000	3.52	20,000	5.86	24,000	7.03	669	1,406	2,080	
	9	12			21	12,600	3.69	21,000	6.15	24,150	7.08	743	1,530	2,264	
	7	15			22	13,200	3.87	22,000	6.45	25,300	7.42	743	1,638	2,425	
	5	18			23	13,800	4.04	23,000	6.74	26,450	7.75	821	1,752	2,593	
	9	15			24	14,400	4.22	24,000	7.03	27,000	7.91	904	1,871	2,770	
	12	12			24	14,400	4.22	24,000	7.03	27,000	7.91	904	1,871	2,770	
	7	18			25	14,400	4.22	24,000	7.03	27,000	7.91	904	1,871	2,770	
	9	18			27	14,400	4.22	24,000	7.03	27,000	7.91	904	1,871	2,770	
	12	15			27	14,400	4.22	24,000	7.03	27,000	7.91	904	1,871	2,770	
	5	24			29	14,400	4.22	24,000	7.03	27,000	7.91	904	1,871	2,770	
	12	18			30	14,400	4.22	24,000	7.03	27,000	7.91	904	1,871	2,770	
	15	15			30	14,400	4.22	24,000	7.03	27,000	7.91	904	1,871	2,770	
	7	24			31	14,400	4.22	24,000	7.03	27,000	7.91	904	1,871	2,770	
	9	24			33	14,400	4.22	24,000	7.03	27,000	7.91	904	1,871	2,770	
	15	18			33	14,400	4.22	24,000	7.03	27,000	7.91	904	1,871	2,770	
	18	18			36	14,400	4.22	24,000	7.03	27,000	7.91	904	1,871	2,770	
	12	24			36	14,400	4.22	24,000	7.03	27,000	7.91	904	1,871	2,770	
	15	24			39	14,400	4.22	24,000	7.03	27,000	7.91	904	1,871	2,770	
	3 UNIT	5	5	5		15	9,000	2.64	15,000	4.40	18,000	5.28	422	837	1,239
		5	5	7		17	10,200	2.99	17,000	4.98	20,400	5.98	481	1,013	1,500
		5	5	9		19	11,400	3.34	19,000	5.57	22,800	6.68	544	1,212	1,794
		5	7	7		19	11,400	3.34	19,000	5.57	22,800	6.68	544	1,212	1,794
		5	7	9		21	12,600	3.69	21,000	6.15	25,200	7.39	682	1,438	2,128
		7	7	7		21	12,600	3.69	21,000	6.15	25,200	7.39	682	1,438	2,128
		5	5	12		22	13,200	3.87	22,000	6.45	26,400	7.74	731	1,540	2,279
		5	9	9		23	13,800	4.04	23,000	6.74	27,600	8.09	731	1,647	2,437
7		7	9		23	13,800	4.04	23,000	6.74	27,600	8.09	731	1,647	2,437	
5		7	12		24	14,400	4.22	24,000	7.03	29,000	8.50	837	1,758	2,603	
5		5	15		25	14,400	4.22	24,000	7.03	29,000	8.50	837	1,758	2,603	
7		9	9		25	14,400	4.22	24,000	7.03	29,000	8.50	837	1,758	2,603	
5		9	12		26	14,400	4.22	24,000	7.03	29,000	8.50	837	1,758	2,603	
7		7	12		26	14,400	4.22	24,000	7.03	29,000	8.50	837	1,758	2,603	
5		7	15		27	14,400	4.22	24,000	7.03	29,000	8.50	837	1,758	2,603	
9		9	9		27	14,400	4.22	24,000	7.03	29,000	8.50	837	1,758	2,603	
7		9	12		28	14,400	4.22	24,000	7.03	29,000	8.50	837	1,758	2,603	
5		5	18		28	14,400	4.22	24,000	7.03	29,000	8.50	837	1,758	2,603	
5		9	15		29	14,400	4.22	24,000	7.03	29,000	8.50	837	1,758	2,603	
5		12	12		29	14,400	4.22	24,000	7.03	29,000	8.50	837	1,758	2,603	
7		7	15		29	14,400	4.22	24,000	7.03	29,000	8.50	837	1,758	2,603	
5		7	18		30	14,400	4.22	24,000	7.03	29,000	8.50	837	1,758	2,603	
9		9	12		30	14,400	4.22	24,000	7.03	29,000	8.50	837	1,758	2,603	
7		9	15		31	14,400	4.22	24,000	7.03	29,000	8.50	837	1,758	2,603	
7		12	12		31	14,400	4.22	24,000	7.03	29,000	8.50	837	1,758	2,603	
5		12	15		32	14,400	4.22	24,000	7.03	29,000	8.50	837	1,758	2,603	
5		9	18		32	14,400	4.22	24,000	7.03	29,000	8.50	837	1,758	2,603	
7		7	18		32	14,400	4.22	24,000	7.03	29,000	8.50	837	1,758	2,603	
9		9	15		33	14,400	4.22	24,000	7.03	29,000	8.50	837	1,758	2,603	
9		12	12		33	14,400	4.22	24,000	7.03	29,000	8.50	837	1,758	2,603	
7	9	18		34	14,400	4.22	24,000	7.03	29,000	8.50	837	1,758	2,603		
7	12	15		34	14,400	4.22	24,000	7.03	29,000	8.50	837	1,758	2,603		
5	5	24		34	14,400	4.22	24,000	7.03	29,000	8.50	837	1,758	2,603		
5	12	18		35	14,400	4.22	24,000	7.03	29,000	8.50	837	1,758	2,603		
5	15	15		35	14,400	4.22	24,000	7.03	29,000	8.50	837	1,758	2,603		
5	7	24		36	14,400	4.22	24,000	7.03	29,000	8.50	837	1,758	2,603		
9	12	15		36	14,400	4.22	24,000	7.03	29,000	8.50	837	1,758	2,603		
12	12	12		36	14,400	4.22	24,000	7.03	29,000	8.50	837	1,758	2,603		
9	9	18		36	14,400	4.22	24,000	7.03	29,000	8.50	837	1,758	2,603		
7	12	18		37	14,400	4.22	24,000	7.03	29,000	8.50	837	1,758	2,603		
7	15	15		37	14,400	4.22	24,000	7.03	29,000	8.50	837	1,758	2,603		
5	9	24		38	14,400	4.22	24,000	7.03	29,000	8.50	837	1,758	2,603		
5	15	18		38	14,400	4.22	24,000	7.03	29,000	8.50	837	1,758	2,603		
7	7	24		38	14,400	4.22	24,000	7.03	29,000	8.50	837	1,758	2,603		
9	12	18		39	14,400	4.22	24,000	7.03	29,000	8.50	837	1,758	2,603		
9	15	15		39	14,400	4.22	24,000	7.03	29,000	8.50	837	1,758	2,603		
12	12	15		39	14,400	4.22	24,000	7.03	29,000	8.50	837	1,758	2,603		

※ For our policy of continuous product improvement, specification, design and features are subject to change without prior notice.



MU4R25

OPERATION	COOLING													
	COMBINATION OF INDOOR UNIT (kBtu/h CLASS)					TOTAL CAPACITY						INPUT(W)		
	UNIT-A	UNIT-B	UNIT-C	UNIT-D	TOTAL	MIN.		RATED		MAX.		MIN.	RATED	MAX.
4 UNIT	5	5	5	5	20	12,000	3.52	20,000	5.86	24,000	7.03	592	1,265	1,872
	5	5	5	7	22	13,200	3.87	22,000	6.45	29,000	8.50	659	1,495	2,212
	5	5	5	9	24	14,400	4.22	24,000	7.03	29,000	8.50	731	1,758	2,603
	5	5	7	7	24	14,400	4.22	24,000	7.03	29,000	8.50	731	1,758	2,603
	5	5	7	9	26	14,400	4.22	24,000	7.03	29,000	8.50	731	1,758	2,603
	5	7	7	7	26	14,400	4.22	24,000	7.03	29,000	8.50	731	1,758	2,603
	5	5	5	12	27	14,400	4.22	24,000	7.03	29,000	8.50	731	1,758	2,603
	5	5	9	9	28	14,400	4.22	24,000	7.03	29,000	8.50	731	1,758	2,603
	5	7	7	9	28	14,400	4.22	24,000	7.03	29,000	8.50	731	1,758	2,603
	7	7	7	7	28	14,400	4.22	24,000	7.03	29,000	8.50	731	1,758	2,603
	5	5	7	12	29	14,400	4.22	24,000	7.03	29,000				



MU4R25

OPERATION	HEATING													
	COMBINATION OF INDOOR UNIT (kBtu/h CLASS)					TOTAL CAPACITY						INPUT(W)		
	UNIT-A	UNIT-B	UNIT-C	UNIT-D	TOTAL	MIN.		RATED		MAX.		MIN.	RATED	MAX.
					Btu/h	kW	Btu/h	kW	Btu/h	kW	MIN.	RATED	MAX.	
1 UNIT	5				5	4,000	1.17	5,500	1.61	6,325	1.85	279	384	589
	7				7	5,040	1.48	8,400	2.46	9,660	2.83	342	579	743
	9				9	6,480	1.90	10,800	3.17	12,420	3.64	483	757	997
	12				12	7,920	2.32	13,200	3.87	15,180	4.45	537	954	1,234
	15				15	9,900	2.90	16,500	4.84	18,975	5.56	688	1,189	1,593
	18				18	11,880	3.48	19,800	5.80	22,770	6.67	845	1,483	1,978
	24				24	15,240	4.47	25,400	7.44	26,670	7.82	1,101	1,840	2,327
2 UNIT	5	5			10	7,200	2.11	12,000	3.52	14,400	4.22	329	598	861
	5	7			12	8,640	2.53	14,400	4.22	17,280	5.06	430	904	1,301
	5	9			14	10,080	2.95	16,800	4.92	20,160	5.91	484	945	1,360
	7	7			14	10,080	2.95	16,800	4.92	20,160	5.91	484	945	1,360
	7	9			16	11,520	3.38	19,200	5.63	23,040	6.75	540	1,118	1,610
	5	12			17	12,240	3.59	20,400	5.98	24,480	7.17	598	1,319	1,899
	9	9			18	12,960	3.80	21,600	6.33	25,920	7.60	660	1,430	2,059
	7	12			19	13,680	4.01	22,800	6.68	27,360	8.02	725	1,543	2,221
	5	15			20	14,400	4.22	24,000	7.03	28,800	8.44	764	1,662	2,393
	9	12			21	15,120	4.43	25,200	7.39	29,000	8.50	793	1,749	2,518
	7	15			22	15,840	4.64	26,400	7.74	29,000	8.50	867	1,836	2,644
	5	18			23	16,560	4.85	27,600	8.09	29,000	8.50	945	1,977	2,850
	9	15			24	16,560	4.85	27,600	8.09	29,000	8.50	945	1,977	2,850
	12	12			24	16,560	4.85	27,600	8.09	29,000	8.50	945	1,977	2,850
	7	18			25	16,560	4.85	27,600	8.09	29,000	8.50	945	1,977	2,850
9	18			27	16,560	4.85	27,600	8.09	29,000	8.50	945	1,977	2,850	
12	15			27	16,560	4.85	27,600	8.09	29,000	8.50	945	1,977	2,850	
5	24			29	16,560	4.85	27,600	8.09	29,000	8.50	945	1,977	2,850	
12	18			30	16,560	4.85	27,600	8.09	29,000	8.50	945	1,977	2,850	
15	15			30	16,560	4.85	27,600	8.09	29,000	8.50	945	1,977	2,850	
7	24			31	16,560	4.85	27,600	8.09	29,000	8.50	945	1,977	2,850	
9	24			33	16,560	4.85	27,600	8.09	29,000	8.50	945	1,977	2,850	
15	18			33	16,560	4.85	27,600	8.09	29,000	8.50	945	1,977	2,850	
18	18			36	16,560	4.85	27,600	8.09	29,000	8.50	945	1,977	2,850	
12	24			36	16,560	4.85	27,600	8.09	29,000	8.50	945	1,977	2,850	
15	24			39	16,560	4.85	27,600	8.09	29,000	8.50	945	1,977	2,850	
3 UNIT	5	5	5		15	10,800	3.17	18,000	5.28	21,600	6.33	497	946	1,363
	5	5	7		17	12,240	3.59	20,400	5.98	24,480	7.17	551	1,118	1,610
	5	5	9		19	13,680	4.01	22,800	6.68	27,360	8.02	725	1,419	2,044
	5	7	7		19	13,680	4.01	22,800	6.68	27,360	8.02	725	1,419	2,044
	5	7	9		21	15,120	4.43	25,200	7.39	30,240	8.86	730	1,610	2,319
	7	7	7		21	15,120	4.43	25,200	7.39	30,240	8.86	730	1,610	2,319
	5	5	12		22	15,840	4.64	26,400	7.74	31,000	9.09	798	1,697	2,444
	5	9	9		23	16,560	4.85	27,600	8.09	31,000	9.09	870	1,838	2,647
	7	7	9		23	16,560	4.85	27,600	8.09	31,000	9.09	870	1,838	2,647
	5	7	12		24	16,560	4.85	27,600	8.09	31,000	9.09	870	1,838	2,647
	5	5	15		25	16,560	4.85	27,600	8.09	31,000	9.09	870	1,838	2,647
	7	9	9		25	16,560	4.85	27,600	8.09	31,000	9.09	870	1,838	2,647
	5	9	12		26	16,560	4.85	27,600	8.09	31,000	9.09	870	1,838	2,647
	7	7	12		26	16,560	4.85	27,600	8.09	31,000	9.09	870	1,838	2,647
	5	7	15		27	16,560	4.85	27,600	8.09	31,000	9.09	870	1,838	2,647
	9	9	9		27	16,560	4.85	27,600	8.09	31,000	9.09	870	1,838	2,647
	7	9	12		28	16,560	4.85	27,600	8.09	31,000	9.09	870	1,838	2,647
	5	5	18		28	16,560	4.85	27,600	8.09	31,000	9.09	870	1,838	2,647
	5	9	15		29	16,560	4.85	27,600	8.09	31,000	9.09	870	1,838	2,647
	5	12	12		29	16,560	4.85	27,600	8.09	31,000	9.09	870	1,838	2,647
	7	7	15		29	16,560	4.85	27,600	8.09	31,000	9.09	870	1,838	2,647
	5	7	18		30	16,560	4.85	27,600	8.09	31,000	9.09	870	1,838	2,647
	9	9	12		30	16,560	4.85	27,600	8.09	31,000	9.09	870	1,838	2,647
	7	9	15		31	16,560	4.85	27,600	8.09	31,000	9.09	870	1,838	2,647
	7	12	12		31	16,560	4.85	27,600	8.09	31,000	9.09	870	1,838	2,647
	5	12	15		32	16,560	4.85	27,600	8.09	31,000	9.09	870	1,838	2,647
	5	9	18		32	16,560	4.85	27,600	8.09	31,000	9.09	870	1,838	2,647
	7	7	18		32	16,560	4.85	27,600	8.09	31,000	9.09	870	1,838	2,647
	9	9	15		33	16,560	4.85	27,600	8.09	31,000	9.09	870	1,838	2,647
	9	12	12		33	16,560	4.85	27,600	8.09	31,000	9.09	870	1,838	2,647
	7	9	18		34	16,560	4.85	27,600	8.09	31,000	9.09	870	1,838	2,647
	7	12	15		34	16,560	4.85	27,600	8.09	31,000	9.09	870	1,838	2,647
	5	5	24		34	16,560	4.85	27,600	8.09	31,000	9.09	870	1,838	2,647
5	12	18		35	16,560	4.85	27,600	8.09	31,000	9.09	870	1,838	2,647	
5	15	15		35	16,560	4.85	27,600	8.09	31,000	9.09	870	1,838	2,647	
5	7	24		36	16,560	4.85	27,600	8.09	31,000	9.09	870	1,838	2,647	
9	12	15		36	16,560	4.85	27,600	8.09	31,000	9.09	870	1,838	2,647	
12	12	12		36	16,560	4.85	27,600	8.09	31,000	9.09	870	1,838	2,647	
9	9	18		36	16,560	4.85	27,600	8.09	31,000	9.09	870	1,838	2,647	
7	12	18		37	16,560	4.85	27,600	8.09	31,000	9.09	870	1,838	2,647	
7	15	15		37	16,560	4.85	27,600	8.09	31,000	9.09	870	1,838	2,647	
5	9	24		38	16,560	4.85	27,600	8.09	31,000	9.09	870	1,838	2,647	
5	15	18		38	16,560	4.85	27,600	8.09	31,000	9.09	870	1,838	2,647	
7	7	24		38	16,560	4.85	27,600	8.09	31,000	9.09	870	1,838	2,647	
9	12	18		39	16,560	4.85	27,600	8.09	31,000	9.09	870	1,838	2,647	
9	15	15		39	16,560	4.85	27,600	8.09	31,000	9.09	870	1,838	2,647	
12	12	15		39	16,560	4.85	27,600	8.09	31,000	9.09	870	1,838	2,647	

※ For our policy of continuous product improvement, specification, design and features are subject to change without prior notice.



MU4R25

OPERATION	HEATING													
	COMBINATION OF INDOOR UNIT (kBtu/h CLASS)					TOTAL CAPACITY						INPUT(W)		
	UNIT-A	UNIT-B	UNIT-C	UNIT-D	TOTAL	MIN.		RATED		MAX.		MIN.	RATED	MAX.
					Btu/h	kW	Btu/h	kW	Btu/h	kW	MIN.	RATED	MAX.	
4 UNIT	5	5	5	5	20	14,400	4.22	24,000	7.03	28,800	8.44	700	1,418	2,041
	5	5	5	7	22	15,840	4.64	26,400	7.74	31,000	9.09	795	1,625	2,339
	5	5	5	9	24	16,560	4.85	27,600	8.09	31,000	9.09	832	1,838	2,647
	5	5	7	7	24	16,560	4.85	27,600	8.09	31,000	9.09	832	1,838	2,647
	5	5	7	9	26	16,560	4.85	27,600	8.09	31,000	9.09	832	1,838	2,647
	5	7	7	7	26	16,560	4.85	27,600	8.09	31,000	9.09	832	1,838	2,647
	5	5	5	12	27	16,560	4.85	27,600	8.09	31,000	9.09	832	1,838	2,647
	5	5	9	9	28	16,560	4.85	27,600	8.09	31,000	9.09	832	1,838	2,647
	5	7	7	9	28	16,560	4.85	27,600	8.09	31,000	9.09	832	1,838	2,647
	7	7	7	7	28	16,560	4.85	27,600	8.09	31,000	9.09	832	1,838	2,647
	5	5	7	12	29	16,560	4.85	27,600	8.09	31,000	9.09	832	1,838	2,647
	5	5	5	15	30	16,560	4.85	27,600	8.09	31,000	9.09	832	1,838	2,647
	5	7	9	9	30	16,560	4.85	27,600	8.09	31,000	9.09	832	1,838	2,647
	7	7	7											

COMBINATION TABLE



MU4R27

OPERATION	COOLING													
	COMBINATION OF INDOOR UNIT (kBtu/h CLASS)					TOTAL CAPACITY						INPUT(W)		
	UNIT-A	UNIT-B	UNIT-C	UNIT-D	TOTAL	MIN.		RATED		MAX.		MIN.	RATED	MAX.
					Btu/h	kW	Btu/h	kW	Btu/h	kW	MIN.	RATED	MAX.	
1 UNIT	5				5	4,500	1.32	5,000	1.47	6,000	1.76	416	418	612
	7				7	4,800	1.41	7,000	2.05	8,400	2.46	416	494	663
	9				9	5,400	1.58	9,000	2.64	10,800	3.17	416	617	861
	12				12	7,200	2.11	12,000	3.52	14,400	4.22	494	846	1,153
	15				15	8,520	2.50	14,200	4.16	17,040	4.99	592	1,029	1,395
	18				18	10,800	3.17	18,000	5.28	21,600	6.33	769	1,328	1,804
	24				24	14,400	4.22	24,000	7.03	25,500	7.47	1,029	1,815	2,536
	5	5			10	6,000	1.76	10,000	2.93	12,000	3.52	378	623	853
	5	7			12	7,200	2.11	12,000	3.52	14,400	4.22	444	761	1,038
	5	9			14	8,400	2.46	14,000	4.10	16,800	4.92	533	903	1,228
	7	7			14	8,400	2.46	14,000	4.10	16,800	4.92	533	903	1,228
	7	9			16	9,600	2.81	16,000	4.69	19,200	5.63	601	1,047	1,423
5	12			17	10,200	2.99	17,000	4.98	20,400	5.98	646	1,121	1,537	
9	9			18	10,800	3.17	18,000	5.28	21,600	6.33	692	1,195	1,623	
7	12			19	11,400	3.34	19,000	5.57	22,800	6.68	715	1,270	1,740	
5	15			20	12,000	3.52	20,000	5.86	24,000	7.03	761	1,347	1,829	
9	12			21	12,600	3.69	21,000	6.15	25,200	7.39	808	1,423	2,012	
7	15			22	13,200	3.87	22,000	6.45	26,400	7.74	855	1,475	2,154	
5	18			23	13,800	4.04	23,000	6.74	27,600	8.09	879	1,554	2,351	
9	15			24	14,400	4.22	24,000	7.03	28,800	8.44	927	1,633	2,505	
12	12			24	14,400	4.22	24,000	7.03	28,800	8.44	927	1,633	2,505	
7	18			25	15,000	4.40	25,000	7.33	30,000	8.79	975	1,755	2,721	
9	18			27	16,200	4.75	27,000	7.91	31,050	9.10	1,047	2,011	2,891	
12	15			27	16,200	4.75	27,000	7.91	31,050	9.10	1,047	2,011	2,891	
5	24			29	16,200	4.75	27,000	7.91	31,050	9.10	1,047	2,011	2,891	
12	18			30	16,200	4.75	27,000	7.91	31,050	9.10	1,047	2,011	2,891	
15	15			30	16,200	4.75	27,000	7.91	31,050	9.10	1,047	2,011	2,891	
7	24			31	16,200	4.75	27,000	7.91	31,050	9.10	1,047	2,011	2,891	
9	24			33	16,200	4.75	27,000	7.91	31,050	9.10	1,047	2,011	2,891	
15	18			33	16,200	4.75	27,000	7.91	31,050	9.10	1,047	2,011	2,891	
18	18			36	16,200	4.75	27,000	7.91	31,050	9.10	1,047	2,011	2,891	
12	24			36	16,200	4.75	27,000	7.91	31,050	9.10	1,047	2,011	2,891	
15	24			39	16,200	4.75	27,000	7.91	31,050	9.10	1,047	2,011	2,891	
5	5	5		15	9,000	2.64	15,000	4.40	18,000	5.28	522	916	1,258	
5	5	7		17	10,200	2.99	17,000	4.98	20,400	5.98	607	1,054	1,445	
5	5	9		19	11,400	3.34	19,000	5.57	22,800	6.68	672	1,194	1,636	
5	7	7		19	11,400	3.34	19,000	5.57	22,800	6.68	672	1,194	1,636	
5	7	9		21	12,600	3.69	21,000	6.15	25,200	7.39	760	1,338	1,891	
7	7	7		21	12,600	3.69	21,000	6.15	25,200	7.39	760	1,338	1,891	
5	5	12		22	13,200	3.87	22,000	6.45	26,400	7.74	804	1,387	2,025	
5	9	9		23	13,800	4.04	23,000	6.74	27,600	8.09	826	1,461	2,219	
7	7	9		23	13,800	4.04	23,000	6.74	27,600	8.09	826	1,461	2,219	
5	7	12		24	14,400	4.22	24,000	7.03	28,800	8.44	871	1,535	2,379	
5	5	15		25	15,000	4.40	25,000	7.33	30,000	8.79	916	1,650	2,605	
7	9	9		25	15,000	4.40	25,000	7.33	30,000	8.79	916	1,650	2,605	
5	9	12		26	15,600	4.57	26,000	7.62	31,200	9.14	962	1,767	2,784	
7	7	12		26	15,600	4.57	26,000	7.62	31,200	9.14	962	1,767	2,784	
5	7	15		27	16,200	4.75	27,000	7.91	31,050	9.10	984	1,890	2,784	
9	9	9		27	16,200	4.75	27,000	7.91	31,050	9.10	984	1,890	2,784	
7	9	12		28	16,200	4.75	27,000	7.91	31,050	9.10	984	1,890	2,784	
5	5	18		28	16,200	4.75	27,000	7.91	31,050	9.10	984	1,890	2,784	
5	9	15		29	16,200	4.75	27,000	7.91	31,050	9.10	984	1,890	2,784	
5	12	12		29	16,200	4.75	27,000	7.91	31,050	9.10	984	1,890	2,784	
7	7	15		29	16,200	4.75	27,000	7.91	31,050	9.10	984	1,890	2,784	
5	7	18		30	16,200	4.75	27,000	7.91	31,050	9.10	984	1,890	2,784	
9	9	12		30	16,200	4.75	27,000	7.91	31,050	9.10	984	1,890	2,784	
7	9	15		31	16,200	4.75	27,000	7.91	31,050	9.10	984	1,890	2,784	
7	12	12		31	16,200	4.75	27,000	7.91	31,050	9.10	984	1,890	2,784	
5	12	15		32	16,200	4.75	27,000	7.91	31,050	9.10	984	1,890	2,784	
5	9	18		32	16,200	4.75	27,000	7.91	31,050	9.10	984	1,890	2,784	
7	7	18		32	16,200	4.75	27,000	7.91	31,050	9.10	984	1,890	2,784	
9	9	15		33	16,200	4.75	27,000	7.91	31,050	9.10	984	1,890	2,784	
9	12	12		33	16,200	4.75	27,000	7.91	31,050	9.10	984	1,890	2,784	
7	9	18		34	16,200	4.75	27,000	7.91	31,050	9.10	984	1,890	2,784	
7	12	15		34	16,200	4.75	27,000	7.91	31,050	9.10	984	1,890	2,784	
5	5	24		34	16,200	4.75	27,000	7.91	31,050	9.10	984	1,890	2,784	
5	12	18		35	16,200	4.75	27,000	7.91	31,050	9.10	984	1,890	2,784	
5	15	15		35	16,200	4.75	27,000	7.91	31,050	9.10	984	1,890	2,784	
9	7	24		36	16,200	4.75	27,000	7.91	31,050	9.10	984	1,890	2,784	
9	12	15		36	16,200	4.75	27,000	7.91	31,050	9.10	984	1,890	2,784	
12	12	12		36	16,200	4.75	27,000	7.91	31,050	9.10	984	1,890	2,784	
9	9	18		36	16,200	4.75	27,000	7.91	31,050	9.10	984	1,890	2,784	
7	12	18		37	16,200	4.75	27,000	7.91	31,050	9.10	984	1,890	2,784	
7	15	15		37	16,200	4.75	27,000	7.91	31,050	9.10	984	1,890	2,784	
5	9	24		38	16,200	4.75	27,000	7.91	31,050	9.10	984	1,890	2,784	
5	15	18		38	16,200	4.75	27,000	7.91	31,050	9.10	984	1,890	2,784	
7	7	24		38	16,200	4.75	27,000	7.91	31,050	9.10	984	1,890	2,784	
9	12	18		39	16,200	4.75	27,000	7.91	31,050	9.10	984	1,890	2,784	
9	15	15		39	16,200	4.75	27,000	7.91	31,050	9.10	984	1,890	2,784	
12	12	15		39	16,200	4.75	27,000	7.91	31,050	9.10	984	1,890	2,784	
7	9	24		40	16,200	4.75	27,000	7.91	31,050	9.10	984	1,890	2,784	
7	15	18		40	16,200	4.75	27,000	7.91	31,050	9.10	984	1,890	2,784	
5	12	24		41	16,200	4.75	27,000	7.91	31,050	9.10	984	1,890	2,784	
5	18	18		41	16,200	4.75	27,000	7.91	31,050	9.10	984	1,890	2,784	

※ For our policy of continuous product improvement, specification, design and features are subject to change without prior notice.



MU4R27

OPERATION	COOLING													
	COMBINATION OF INDOOR UNIT (kBtu/h CLASS)					TOTAL CAPACITY						INPUT(W)		
	UNIT-A	UNIT-B	UNIT-C	UNIT-D	TOTAL	MIN.		RATED		MAX.		MIN.	RATED	MAX.
					Btu/h	kW	Btu/h	kW	Btu/h	kW	MIN.	RATED	MAX.	
1 UNIT	5				5	4,500	1.32	5,000	1.47	6,000	1.76	416	418	612
	7				7	4,800	1.41	7,000	2.05	8,400	2.46	416	494	663
	9				9	5,400	1.58	9,000	2.64	10,800	3.17	416	617	861
	12				12	7,200	2.11	12,000	3.52	14,400	4.22	494	846	1,153
	15				15	8,520	2.50	14,200	4.16	17,040	4.99	592	1,029	1,395
	18				18	10,800	3.17	18,000	5.28	21,600	6.33	769	1,328	1,804
	24				24	14,400	4.22	24,000	7.03	25,500	7.47	1,029	1,815	2,536
	5	5			10	6,000	1.76	10,000	2.93	12,000	3.52	378	623	853
	5	7			12	7,200	2.11	12,000	3.52	14,400	4.22	444	761	1,038
	5	9			14	8,400	2.46	14,000	4.10	16,800	4.92	533	903	1,228
	7	7</												



MU4R27

OPERATION	COMBINATION OF INDOOR UNIT (kBTU/h CLASS)				HEATING						INPUT(W)			
	UNIT-A	UNIT-B	UNIT-C	UNIT-D	TOTAL	MIN.		RATED		MAX.		MIN.	RATED	MAX.
						Btu/h	kW	Btu/h	kW	Btu/h	kW			
1 UNIT	5				5	5,000	1.47	5,500	1.61	6,325	1.85	610	610	714
	7				7	5,400	1.58	8,400	2.46	9,660	2.83	610	636	825
	9				9	6,480	1.90	10,800	3.17	12,420	3.64	610	826	1,077
	12				12	7,920	2.32	13,200	3.87	15,180	4.45	583	1,021	1,338
	15				15	9,900	2.90	16,500	4.84	18,975	5.56	744	1,279	1,744
	18				18	11,880	3.48	19,800	5.80	22,770	6.67	909	1,577	2,133
	24				24	15,240	4.47	25,400	7.44	26,670	7.82	1,192	2,077	2,538
	5	5			10	7,200	2.11	12,000	3.52	14,400	4.22	451	773	1,081
	5	7			12	8,640	2.53	14,400	4.22	17,280	5.06	541	940	1,337
	5	9			14	10,080	2.95	16,800	4.92	20,160	5.91	656	1,112	1,571
	7	7			14	10,080	2.95	16,800	4.92	20,160	5.91	656	1,112	1,571
	7	9			16	11,520	3.38	19,200	5.63	23,040	6.75	749	1,289	1,844
	5	12			17	12,240	3.59	20,400	5.98	24,480	7.17	796	1,392	1,968
	9	9			18	12,960	3.80	21,600	6.33	25,920	7.60	844	1,471	2,094
	7	12			19	13,680	4.01	22,800	6.68	27,360	8.02	892	1,577	2,222
5	15			20	14,400	4.22	24,000	7.03	28,800	8.44	940	1,657	2,352	
9	12			21	15,120	4.43	25,200	7.39	30,240	8.86	989	1,766	2,568	
7	15			22	15,840	4.64	26,400	7.74	31,680	9.28	1,038	1,848	2,811	
5	18			23	16,560	4.85	27,600	8.09	33,120	9.71	1,112	1,960	3,127	
2 UNIT	5	15			24	17,280	5.06	28,800	8.44	34,100	9.99	1,100	2,045	3,384
	12	12			24	17,280	5.06	28,800	8.44	34,100	9.99	1,100	2,045	3,384
	7	18			25	18,000	5.28	30,000	8.79	34,100	9.99	1,147	2,194	3,384
	9	18			27	18,600	5.45	31,000	9.09	34,100	9.99	1,194	2,157	3,384
	12	15			27	18,600	5.45	31,000	9.09	34,100	9.99	1,194	2,157	3,384
	5	24			29	18,600	5.45	31,000	9.09	34,100	9.99	1,194	2,157	3,384
	12	18			30	18,600	5.45	31,000	9.09	34,100	9.99	1,194	2,157	3,384
	15	15			30	18,600	5.45	31,000	9.09	34,100	9.99	1,194	2,157	3,384
	7	24			31	18,600	5.45	31,000	9.09	34,100	9.99	1,194	2,157	3,384
	9	24			33	18,600	5.45	31,000	9.09	34,100	9.99	1,194	2,157	3,384
	15	18			33	18,600	5.45	31,000	9.09	34,100	9.99	1,194	2,157	3,384
	18	18			36	18,600	5.45	31,000	9.09	34,100	9.99	1,194	2,157	3,384
	12	24			36	18,600	5.45	31,000	9.09	34,100	9.99	1,194	2,157	3,384
	15	24			39	18,600	5.45	31,000	9.09	34,100	9.99	1,194	2,157	3,384
	3 UNIT	5	5	5		15	10,800	3.17	18,000	5.28	21,600	6.33	660	1,140
5		5	7		17	12,240	3.59	20,400	5.98	24,480	7.17	748	1,309	1,850
5		5	9		19	13,680	4.01	22,800	6.68	27,360	8.02	838	1,482	2,089
5		7	7		19	13,680	4.01	22,800	6.68	27,360	8.02	838	1,482	2,089
5		7	9		21	15,120	4.43	25,200	7.39	30,240	8.86	930	1,660	2,414
7		7	7		21	15,120	4.43	25,200	7.39	30,240	8.86	930	1,660	2,414
5		5	12		22	15,840	4.64	26,400	7.74	31,680	9.28	976	1,738	2,590
5		9	9		23	16,560	4.85	27,600	8.09	33,120	9.71	1,046	1,842	2,767
7		7	9		23	16,560	4.85	27,600	8.09	33,120	9.71	1,046	1,842	2,767
5		7	12		24	17,280	5.06	28,800	8.44	34,560	10.13	1,093	1,922	2,951
5		5	15		25	18,000	5.28	30,000	8.79	34,720	10.18	1,140	2,063	2,998
7		9	9		25	18,000	5.28	30,000	8.79	34,720	10.18	1,140	2,063	2,998
5		9	12		26	18,720	5.49	31,200	9.14	34,720	10.18	1,188	2,177	2,998
7		7	12		26	18,720	5.49	31,200	9.14	34,720	10.18	1,188	2,177	2,998
5		7	15		27	18,600	5.45	31,000	9.09	34,720	10.18	1,188	2,177	2,998
9		9	9		27	18,600	5.45	31,000	9.09	34,720	10.18	1,188	2,177	2,998
7		9	12		28	18,600	5.45	31,000	9.09	34,720	10.18	1,188	2,177	2,998
5		5	18		28	18,600	5.45	31,000	9.09	34,720	10.18	1,188	2,177	2,998
5		9	15		29	18,600	5.45	31,000	9.09	34,720	10.18	1,188	2,177	2,998
5		12	12		29	18,600	5.45	31,000	9.09	34,720	10.18	1,188	2,177	2,998
7		7	15		29	18,600	5.45	31,000	9.09	34,720	10.18	1,188	2,177	2,998
5		7	18		30	18,600	5.45	31,000	9.09	34,720	10.18	1,188	2,177	2,998
9		9	12		30	18,600	5.45	31,000	9.09	34,720	10.18	1,188	2,177	2,998
7		9	15		31	18,600	5.45	31,000	9.09	34,720	10.18	1,188	2,177	2,998
5		12	12		31	18,600	5.45	31,000	9.09	34,720	10.18	1,188	2,177	2,998
5		12	15		32	18,600	5.45	31,000	9.09	34,720	10.18	1,188	2,177	2,998
5		9	18		32	18,600	5.45	31,000	9.09	34,720	10.18	1,188	2,177	2,998
7		7	18		32	18,600	5.45	31,000	9.09	34,720	10.18	1,188	2,177	2,998
9		9	15		33	18,600	5.45	31,000	9.09	34,720	10.18	1,188	2,177	2,998
9		12	12		33	18,600	5.45	31,000	9.09	34,720	10.18	1,188	2,177	2,998
7	9	18		34	18,600	5.45	31,000	9.09	34,720	10.18	1,188	2,177	2,998	
7	12	15		34	18,600	5.45	31,000	9.09	34,720	10.18	1,188	2,177	2,998	
5	5	24		34	18,600	5.45	31,000	9.09	34,720	10.18	1,188	2,177	2,998	
5	12	18		35	18,600	5.45	31,000	9.09	34,720	10.18	1,188	2,177	2,998	
5	15	15		35	18,600	5.45	31,000	9.09	34,720	10.18	1,188	2,177	2,998	
9	7	24		36	18,600	5.45	31,000	9.09	34,720	10.18	1,188	2,177	2,998	
9	12	15		36	18,600	5.45	31,000	9.09	34,720	10.18	1,188	2,177	2,998	
12	12	12		36	18,600	5.45	31,000	9.09	34,720	10.18	1,188	2,177	2,998	
9	9	18		36	18,600	5.45	31,000	9.09	34,720	10.18	1,188	2,177	2,998	
7	12	18		37	18,600	5.45	31,000	9.09	34,720	10.18	1,188	2,177	2,998	
7	15	15		37	18,600	5.45	31,000	9.09	34,720	10.18	1,188	2,177	2,998	
5	9	24		38	18,600	5.45	31,000	9.09	34,720	10.18	1,188	2,177	2,998	
5	15	18		38	18,600	5.45	31,000	9.09	34,720	10.18	1,188	2,177	2,998	
7	7	24		38	18,600	5.45	31,000	9.09	34,720	10.18	1,188	2,177	2,998	
9	12	18		39	18,600	5.45	31,000	9.09	34,720	10.18	1,188	2,177	2,998	
9	15	15		39	18,600	5.45	31,000	9.09	34,720	10.18	1,188	2,177	2,998	
12	12	15		39	18,600	5.45	31,000	9.09	34,720	10.18	1,188	2,177	2,998	
7	9	24		40	18,600	5.45	31,000	9.09	34,720	10.18	1,188	2,177	2,998	
7	15	18		40	18,600	5.45	31,000	9.09	34,720	10.18	1,188	2,177	2,998	
5	12	24		41	18,600	5.45	31,000	9.09	34,720	10.18	1,188	2,177	2,998	
5	18	18		41	18,600	5.45	31,000	9.09	34,720	10.18	1,188	2,177	2,998	

※ For our policy of continuous product improvement, specification, design and features are subject to change without prior notice.



MU4R27

OPERATION	COMBINATION OF INDOOR UNIT (kBTU/h CLASS)				HEATING						INPUT(W)			
	UNIT-A	UNIT-B	UNIT-C	UNIT-D	TOTAL	MIN.		RATED		MAX.		MIN.	RATED	MAX.
						Btu/h	kW	Btu/h	kW	Btu/h	kW			
1 UNIT	5				5	5,000	1.47	5,500	1.61	6,325	1.85	610	610	714
	7				7	5,400	1.58	8,400	2.46	9,660	2.83	610	636	825
	9				9	6,480	1.90	10,800	3.17	12,420	3.64	610	826	1,077
	12				12	7,920	2.32	13,200	3.87	15,180	4.45	583	1,021	1,338
	15				15	9,900	2.90	16,500	4.84	18,975	5.56	744	1,279	1,744
	18				18	11,880	3.48	19,800	5.80	22,770	6.67	909	1,577	2,133
	24				24	15,240	4.47	25,400	7.44	26,670	7.82	1,192	2,077	2,538
	5	5			10	7,200	2.11	12,000	3.52	14,400	4.22	451	773	1,081
	5	7			12	8,640	2.53	14,400	4.22	17,280	5.06	541	940	1,337
	5	9												



MU5R30

OPERATION	COOLING														
	COMBINATION OF INDOOR UNIT (kBtu/h CLASS)						TOTAL CAPACITY						INPUT(W)		
							MIN.		RATED		MAX.				
UNIT-A	UNIT-B	UNIT-C	UNIT-D	UNIT-E	TOTAL	Btu/h	kW	Btu/h	kW	Btu/h	kW	MIN.	RATED	MAX.	
1 UNIT	5					5	4,500	1.32	5,000	1.47	6,000	1.76	416	418	629
	7					7	4,800	1.41	7,000	2.05	8,400	2.46	416	494	681
	9					9	5,400	1.58	9,000	2.64	10,800	3.17	416	617	884
	12					12	7,200	2.11	12,000	3.52	14,400	4.22	494	846	1,184
	15					15	8,520	2.50	14,200	4.16	17,040	4.99	592	1,029	1,432
	18					18	10,800	3.17	18,000	5.28	21,600	6.33	769	1,328	1,852
	24					24	14,400	4.22	24,000	7.03	25,500	7.47	1,029	1,815	2,604
	5	5				10	6,000	1.76	10,000	2.93	12,000	3.52	378	623	876
	5	7				12	7,200	2.11	12,000	3.52	14,400	4.22	444	761	1,066
	5	9				14	8,400	2.46	14,000	4.10	16,800	4.92	533	903	1,261
	7	7				14	8,400	2.46	14,000	4.10	16,800	4.92	533	903	1,261
	7	9				16	9,600	2.81	16,000	4.69	19,200	5.63	601	1,047	1,461
	5	12				17	10,200	2.99	17,000	4.98	20,400	5.98	646	1,121	1,578
	9	9				18	10,800	3.17	18,000	5.28	21,600	6.33	692	1,195	1,667
	7	12				19	11,400	3.34	19,000	5.57	22,800	6.68	715	1,270	1,787
5	15				20	12,000	3.52	20,000	5.86	24,000	7.03	761	1,347	1,878	
9	12				21	12,600	3.69	21,000	6.15	25,200	7.39	808	1,423	2,066	
7	15				22	13,200	3.87	22,000	6.45	26,400	7.74	855	1,475	2,211	
5	18				23	13,800	4.04	23,000	6.74	27,600	8.09	879	1,554	2,414	
9	15				24	14,400	4.22	24,000	7.03	28,800	8.44	927	1,633	2,572	
12	12				24	14,400	4.22	24,000	7.03	28,800	8.44	927	1,633	2,572	
7	18				25	15,000	4.40	25,000	7.33	30,000	8.79	975	1,755	2,794	
9	18				27	16,200	4.75	27,000	7.91	32,400	9.50	1,047	2,011	3,213	
12	15				27	16,200	4.75	27,000	7.91	32,400	9.50	1,047	2,011	3,213	
5	24				29	17,400	5.10	29,000	8.50	33,000	9.67	1,145	2,284	3,341	
12	18				30	18,000	5.28	30,000	8.79	33,000	9.67	1,195	2,429	3,341	
15	15				30	18,000	5.28	30,000	8.79	33,000	9.67	1,195	2,429	3,341	
7	24				31	18,000	5.28	30,000	8.79	33,000	9.67	1,195	2,429	3,341	
9	24				33	18,000	5.28	30,000	8.79	33,000	9.67	1,195	2,429	3,341	
15	18				33	18,000	5.28	30,000	8.79	33,000	9.67	1,195	2,429	3,341	
18	18				36	18,000	5.28	30,000	8.79	33,000	9.67	1,195	2,429	3,341	
12	24				36	18,000	5.28	30,000	8.79	33,000	9.67	1,195	2,429	3,341	
15	24				39	18,000	5.28	30,000	8.79	33,000	9.67	1,195	2,429	3,341	
18	24				42	18,000	5.28	30,000	8.79	33,000	9.67	1,195	2,429	3,341	
24	24				48	18,000	5.28	30,000	8.79	33,000	9.67	1,195	2,429	3,341	
5	5	5			15	9,000	2.64	15,000	4.40	18,000	5.28	522	916	1,292	
5	5	7			17	10,200	2.99	17,000	4.98	20,400	5.98	607	1,054	1,483	
5	5	9			19	11,400	3.34	19,000	5.57	22,800	6.68	672	1,194	1,680	
5	7	7			19	11,400	3.34	19,000	5.57	22,800	6.68	672	1,194	1,680	
5	7	9			21	12,600	3.69	21,000	6.15	25,200	7.39	760	1,338	1,942	
7	7	7			21	12,600	3.69	21,000	6.15	25,200	7.39	760	1,338	1,942	
5	5	12			22	13,200	3.87	22,000	6.45	26,400	7.74	804	1,387	2,079	
5	9	9			23	13,800	4.04	23,000	6.74	27,600	8.09	826	1,461	2,278	
7	7	9			23	13,800	4.04	23,000	6.74	27,600	8.09	826	1,461	2,278	
5	7	12			24	14,400	4.22	24,000	7.03	28,800	8.44	871	1,535	2,442	
5	5	15			25	15,000	4.40	25,000	7.33	30,000	8.79	916	1,650	2,674	
7	9	9			25	15,000	4.40	25,000	7.33	30,000	8.79	916	1,650	2,674	
5	9	12			26	15,600	4.57	26,000	7.62	31,200	9.14	962	1,767	2,859	
7	7	12			26	15,600	4.57	26,000	7.62	31,200	9.14	962	1,767	2,859	
5	7	15			27	16,200	4.75	27,000	7.91	32,400	9.50	984	1,890	3,120	
9	9	9			27	16,200	4.75	27,000	7.91	32,400	9.50	984	1,890	3,120	
7	9	12			28	16,800	4.92	28,000	8.21	33,600	9.85	1,030	2,028	3,327	
5	5	18			28	16,800	4.92	28,000	8.21	33,600	9.85	1,030	2,028	3,327	
5	9	15			29	17,400	5.10	29,000	8.50	33,600	9.85	1,077	2,173	3,327	
5	12	12			29	17,400	5.10	29,000	8.50	33,600	9.85	1,077	2,173	3,327	
7	7	15			30	18,000	5.28	30,000	8.79	33,600	9.85	1,123	2,326	3,327	
5	7	18			30	18,000	5.28	30,000	8.79	33,600	9.85	1,123	2,326	3,327	
9	9	12			30	18,000	5.28	30,000	8.79	33,600	9.85	1,123	2,326	3,327	
7	9	15			31	18,000	5.28	30,000	8.79	33,600	9.85	1,123	2,326	3,327	
7	12	12			31	18,000	5.28	30,000	8.79	33,600	9.85	1,123	2,326	3,327	
5	12	15			32	18,000	5.28	30,000	8.79	33,600	9.85	1,123	2,326	3,327	
5	9	18			32	18,000	5.28	30,000	8.79	33,600	9.85	1,123	2,326	3,327	
7	7	18			32	18,000	5.28	30,000	8.79	33,600	9.85	1,123	2,326	3,327	
9	9	15			33	18,000	5.28	30,000	8.79	33,600	9.85	1,123	2,326	3,327	
9	12	12			33	18,000	5.28	30,000	8.79	33,600	9.85	1,123	2,326	3,327	
7	9	18			34	18,000	5.28	30,000	8.79	33,600	9.85	1,123	2,326	3,327	
7	12	15			34	18,000	5.28	30,000	8.79	33,600	9.85	1,123	2,326	3,327	
5	5	24			34	18,000	5.28	30,000	8.79	33,600	9.85	1,123	2,326	3,327	
5	12	18			35	18,000	5.28	30,000	8.79	33,600	9.85	1,123	2,326	3,327	
5	15	15			35	18,000	5.28	30,000	8.79	33,600	9.85	1,123	2,326	3,327	
5	7	24			36	18,000	5.28	30,000	8.79	33,600	9.85	1,123	2,326	3,327	
9	12	15			36	18,000	5.28	30,000	8.79	33,600	9.85	1,123	2,326	3,327	
12	12	12			36	18,000	5.28	30,000	8.79	33,600	9.85	1,123	2,326	3,327	
9	9	18			36	18,000	5.28	30,000	8.79	33,600	9.85	1,123	2,326	3,327	
7	12	18			37	18,000	5.28	30,000	8.79	33,600	9.85	1,123	2,326	3,327	
7	15	15			37	18,000	5.28	30,000	8.79	33,600	9.85	1,123	2,326	3,327	
5	9	24			38	18,000	5.28	30,000	8.79	33,600	9.85	1,123	2,326	3,327	
5	15	18			38	18,000	5.28	30,000	8.79	33,600	9.85	1,123	2,326	3,327	
7	7	24			38	18,000	5.28	30,000	8.79	33,600	9.85	1,123	2,326	3,327	
9	12	18			39	18,000	5.28	30,000	8.79	33,600	9.85	1,123	2,326	3,327	
9	15	15			39	18,000	5.28	30,000	8.79	33,600	9.85	1,123	2,326	3,327	
12	12	15			39	18,000	5.28	30,000	8.79	33,600	9.85	1,123	2,326	3,327	
7	9	24			40	18,000	5.28	30,000	8.79	33,600	9.85	1,123	2,326	3,327	
7	15	18			40	18,000	5.28	30,000	8.79	33,600	9.85	1,123	2,326	3,327	
5	12	24			41	18,000	5.28	30,000	8.79	33,600	9.85	1,123	2,326	3,327	
5	18	18			41	18,000	5.28	30,000	8.79	33,600	9.85	1,123	2,326	3,327	
12	12	18			42	18,000	5.28	30,000	8.79	33,600	9.85	1,123	2,326	3,327	
9	9	24			42	18,000	5.28	30,000	8.79	33,600	9.85	1,123	2,326	3,327	
9	15	18			42	18,000	5.28	30,000	8.79	33,600	9.85	1,123	2,326	3,327	
12	15	15			42	18,000	5.28	30,000	8.79	33,600	9.85	1,123	2,326	3,327	

※ For our policy of continuous product improvement, specification, design and features are subject to change without prior notice.



MU5R30

OPERATION	COOLING														
	COMBINATION OF INDOOR UNIT (kBtu/h CLASS)						TOTAL CAPACITY						INPUT(W)		
							MIN.		RATED		MAX.				
UNIT-A	UNIT-B	UNIT-C	UNIT-D	UNIT-E	TOTAL	Btu/h	kW	Btu/h	kW	Btu/h	kW	MIN.	RATED	MAX.	
3 UNIT	7	18	18												



MU5R30

OPERATION	COOLING															
	COMBINATION OF INDOOR UNIT (kBtu/h CLASS)						TOTAL CAPACITY						INPUT(W)			
							MIN.		RATED		MAX.					
UNIT-A	UNIT-B	UNIT-C	UNIT-D	UNIT-E	TOTAL	Btu/h	kW	Btu/h	kW	Btu/h	kW	MIN.	RATED	MAX.		
5 UNIT	5	5	5	5	5	25	15,000	4.40	25,000	7.33	30,000	8.79	841	1,517	2,300	
	5	5	5	5	7	27	16,200	4.75	27,000	7.91	32,400	9.50	906	1,701	2,645	
	5	5	5	5	9	29	17,400	5.10	29,000	8.50	34,800	10.20	993	1,897	3,026	
	5	5	5	7	7	29	17,400	5.10	29,000	8.50	34,800	10.20	993	1,897	3,026	
	5	5	5	5	7	9	31	18,000	5.28	30,000	8.79	36,000	10.55	1,037	2,000	3,260
	5	5	5	7	7	31	18,000	5.28	30,000	8.79	36,000	10.55	1,037	2,000	3,260	
	5	5	5	5	5	12	32	18,000	5.28	30,000	8.79	36,000	10.55	1,037	2,000	3,260
	5	5	5	5	9	9	33	18,000	5.28	30,000	8.79	36,000	10.55	1,037	2,000	3,260
	5	5	5	7	7	9	33	18,000	5.28	30,000	8.79	36,000	10.55	1,037	2,000	3,260
	5	5	5	7	7	9	33	18,000	5.28	30,000	8.79	36,000	10.55	1,037	2,000	3,260
	5	5	5	5	7	12	34	18,000	5.28	30,000	8.79	36,000	10.55	1,037	2,000	3,260
	5	5	5	5	5	15	35	18,000	5.28	30,000	8.79	36,000	10.55	1,037	2,000	3,260
	5	5	5	7	9	9	35	18,000	5.28	30,000	8.79	36,000	10.55	1,037	2,000	3,260
	5	5	7	7	7	9	35	18,000	5.28	30,000	8.79	36,000	10.55	1,037	2,000	3,260
	5	5	7	7	7	9	35	18,000	5.28	30,000	8.79	36,000	10.55	1,037	2,000	3,260
	5	5	7	7	7	12	35	18,000	5.28	30,000	8.79	36,000	10.55	1,037	2,000	3,260
	5	5	5	5	7	12	36	18,000	5.28	30,000	8.79	36,000	10.55	1,037	2,000	3,260
	5	5	5	5	7	15	37	18,000	5.28	30,000	8.79	36,000	10.55	1,037	2,000	3,260
	5	5	5	9	9	9	37	18,000	5.28	30,000	8.79	36,000	10.55	1,037	2,000	3,260
	5	5	7	7	9	9	37	18,000	5.28	30,000	8.79	36,000	10.55	1,037	2,000	3,260
	5	5	5	5	5	18	38	18,000	5.28	30,000	8.79	36,000	10.55	1,037	2,000	3,260
	5	5	5	7	7	12	38	18,000	5.28	30,000	8.79	36,000	10.55	1,037	2,000	3,260
	5	5	5	5	9	15	39	18,000	5.28	30,000	8.79	36,000	10.55	1,037	2,000	3,260
	5	5	5	5	12	12	39	18,000	5.28	30,000	8.79	36,000	10.55	1,037	2,000	3,260
	5	5	5	7	7	15	39	18,000	5.28	30,000	8.79	36,000	10.55	1,037	2,000	3,260
	5	5	7	7	9	9	39	18,000	5.28	30,000	8.79	36,000	10.55	1,037	2,000	3,260
	5	5	7	9	9	9	39	18,000	5.28	30,000	8.79	36,000	10.55	1,037	2,000	3,260
	5	5	5	5	7	18	40	18,000	5.28	30,000	8.79	36,000	10.55	1,037	2,000	3,260
	5	5	5	9	9	12	40	18,000	5.28	30,000	8.79	36,000	10.55	1,037	2,000	3,260
	5	5	7	7	9	12	40	18,000	5.28	30,000	8.79	36,000	10.55	1,037	2,000	3,260
	5	5	7	7	7	12	40	18,000	5.28	30,000	8.79	36,000	10.55	1,037	2,000	3,260
	5	5	5	7	9	15	41	18,000	5.28	30,000	8.79	36,000	10.55	1,037	2,000	3,260
	5	5	9	9	9	9	41	18,000	5.28	30,000	8.79	36,000	10.55	1,037	2,000	3,260
	5	5	7	9	9	9	41	18,000	5.28	30,000	8.79	36,000	10.55	1,037	2,000	3,260
	5	5	5	5	9	18	42	18,000	5.28	30,000	8.79	36,000	10.55	1,037	2,000	3,260
	5	5	5	5	12	15	42	18,000	5.28	30,000	8.79	36,000	10.55	1,037	2,000	3,260
	5	5	5	7	7	18	42	18,000	5.28	30,000	8.79	36,000	10.55	1,037	2,000	3,260
	5	5	7	9	9	12	42	18,000	5.28	30,000	8.79	36,000	10.55	1,037	2,000	3,260
	5	5	7	9	9	12	42	18,000	5.28	30,000	8.79	36,000	10.55	1,037	2,000	3,260
	5	5	5	9	9	15	43	18,000	5.28	30,000	8.79	36,000	10.55	1,037	2,000	3,260
	5	5	7	9	15	43	18,000	5.28	30,000	8.79	36,000	10.55	1,037	2,000	3,260	
	5	5	7	7	12	43	18,000	5.28	30,000	8.79	36,000	10.55	1,037	2,000	3,260	
	5	5	7	7	15	43	18,000	5.28	30,000	8.79	36,000	10.55	1,037	2,000	3,260	
	5	5	9	9	9	43	18,000	5.28	30,000	8.79	36,000	10.55	1,037	2,000	3,260	
	5	5	7	7	12	44	18,000	5.28	30,000	8.79	36,000	10.55	1,037	2,000	3,260	
	5	5	7	7	15	44	18,000	5.28	30,000	8.79	36,000	10.55	1,037	2,000	3,260	
	5	5	9	9	9	44	18,000	5.28	30,000	8.79	36,000	10.55	1,037	2,000	3,260	
	5	5	7	9	9	44	18,000	5.28	30,000	8.79	36,000	10.55	1,037	2,000	3,260	
5	5	5	5	12	45	18,000	5.28	30,000	8.79	36,000	10.55	1,037	2,000	3,260		
5	5	5	5	15	45	18,000	5.28	30,000	8.79	36,000	10.55	1,037	2,000	3,260		
5	5	7	9	9	45	18,000	5.28	30,000	8.79	36,000	10.55	1,037	2,000	3,260		
5	5	7	9	12	45	18,000	5.28	30,000	8.79	36,000	10.55	1,037	2,000	3,260		
5	5	7	7	9	45	18,000	5.28	30,000	8.79	36,000	10.55	1,037	2,000	3,260		
5	5	7	7	12	45	18,000	5.28	30,000	8.79	36,000	10.55	1,037	2,000	3,260		
5	5	9	9	9	45	18,000	5.28	30,000	8.79	36,000	10.55	1,037	2,000	3,260		
5	5	5	5	7	24	46	18,000	5.28	30,000	8.79	36,000	10.55	1,037	2,000	3,260	
5	5	5	9	9	18	46	18,000	5.28	30,000	8.79	36,000	10.55	1,037	2,000	3,260	
5	5	5	9	12	46	18,000	5.28	30,000	8.79	36,000	10.55	1,037	2,000	3,260		
5	5	7	7	9	18	46	18,000	5.28	30,000	8.79	36,000	10.55	1,037	2,000	3,260	
5	5	7	7	12	46	18,000	5.28	30,000	8.79	36,000	10.55	1,037	2,000	3,260		
5	5	7	7	7	18	46	18,000	5.28	30,000	8.79	36,000	10.55	1,037	2,000	3,260	
5	5	9	9	9	46	18,000	5.28	30,000	8.79	36,000	10.55	1,037	2,000	3,260		
5	5	5	7	15	47	18,000	5.28	30,000	8.79	36,000	10.55	1,037	2,000	3,260		
5	5	9	9	9	47	18,000	5.28	30,000	8.79	36,000	10.55	1,037	2,000	3,260		
5	5	7	9	12	47	18,000	5.28	30,000	8.79	36,000	10.55	1,037	2,000	3,260		
5	5	7	9	15	47	18,000	5.28	30,000	8.79	36,000	10.55	1,037	2,000	3,260		
5	5	7	9	12	47	18,000	5.28	30,000	8.79	36,000	10.55	1,037	2,000	3,260		
5	5	5	5	9	24	48	18,000	5.28	30,000	8.79	36,000	10.55	1,037	2,000	3,260	
5	5	5	5	18	48	18,000	5.28	30,000	8.79	36,000	10.55	1,037	2,000	3,260		
5	5	5	7	24	48	18,000	5.28	30,000	8.79	36,000	10.55	1,037	2,000	3,260		
5	5	7	9	18	48	18,000	5.28	30,000	8.79	36,000	10.55	1,037	2,000	3,260		
5	5	7	9	12	48	18,000	5.28	30,000	8.79	36,000	10.55	1,037	2,000	3,260		
5	5	7	7	12	48	18,000	5.28	30,000	8.79	36,000	10.55	1,037	2,000	3,260		
5	5	9	9	9	48	18,000	5.28	30,000	8.79	36,000	10.55	1,037	2,000	3,260		
5	5	7	7	9	48	18,000	5.28	30,000	8.79	36,000	10.55	1,037	2,000	3,260		

※ For our policy of continuous product improvement, specification, design and features are subject to change without prior notice.



MU5R30

OPERATION	HEATING														
	COMBINATION OF INDOOR UNIT (kBtu/h CLASS)						TOTAL CAPACITY						INPUT(W)		
							MIN.		RATED		MAX.				
UNIT-A	UNIT-B	UNIT-C	UNIT-D	UNIT-E	TOTAL	Btu/h	kW	Btu/h	kW	Btu/h	kW	MIN.	RATED	MAX.	
1 UNIT	5					5	5,000	1.47	5,500	1.61	6,325	1.85	610	610	714
	7					7	5,500	1.61	8,400	2.46	9,660	2.83	610	636	825
	9					9	6,480	1.90	10,800	3.17	12,420	3.64	610	826	1,077
	12					12	7,920	2.32	13,200	3.87	15,180	4.45	583	1,021	1,338
	15					15	9,900	2.90	16,500	4.84	18,975	5.56	744	1,279	1,744
	18					18	11,880	3.48	19,800	5.80	22,770	6.67	909	1,577	2,133
	24					24	15,240	4.47	25,400	7.44	26,670	7.82	1,192	2,077	2,538
	5	5				10	7,200	2.11	12,000	3.52	14,400	4.22	451	773	1,081
	5	7				12	8,640	2.53	14,400	4.22	17,280	5.06	541	940	1,337
	5	9				14	10,080	2.95</							



MU5R30

OPERATION	HEATING														
	COMBINATION OF INDOOR UNIT (kBtu/h CLASS)						TOTAL CAPACITY						INPUT(W)		
	UNIT-A	UNIT-B	UNIT-C	UNIT-D	UNIT-E	TOTAL	MIN.		RATED		MAX.		MIN.	RATED	MAX.
						Btu/h	kW	Btu/h	kW	Btu/h	kW				
3 UNIT	7	18	18			43	20,700	6.07	34,500	10.11	38,640	11.32	1,333	2,566	3,602
	7	12	24			43	20,700	6.07	34,500	10.11	38,640	11.32	1,333	2,566	3,602
	5	15	24			44	20,700	6.07	34,500	10.11	38,640	11.32	1,333	2,566	3,602
	9	18	18			45	20,700	6.07	34,500	10.11	38,640	11.32	1,333	2,566	3,602
	9	12	24			45	20,700	6.07	34,500	10.11	38,640	11.32	1,333	2,566	3,602
	12	15	18			45	20,700	6.07	34,500	10.11	38,640	11.32	1,333	2,566	3,602
	15	15	15			45	20,700	6.07	34,500	10.11	38,640	11.32	1,333	2,566	3,602
	7	15	24			46	20,700	6.07	34,500	10.11	38,640	11.32	1,333	2,566	3,602
	5	18	24			47	20,700	6.07	34,500	10.11	38,640	11.32	1,333	2,566	3,602
	9	15	24			48	20,700	6.07	34,500	10.11	38,640	11.32	1,333	2,566	3,602
	12	18	18			48	20,700	6.07	34,500	10.11	38,640	11.32	1,333	2,566	3,602
	12	12	24			48	20,700	6.07	34,500	10.11	38,640	11.32	1,333	2,566	3,602
	15	15	18			48	20,700	6.07	34,500	10.11	38,640	11.32	1,333	2,566	3,602
	5	5	5	5		20	14,400	4.22	24,000	7.03	28,800	8.44	840	1,480	2,100
	5	5	5	5	7	22	15,840	4.64	26,400	7.74	31,680	9.28	927	1,651	2,470
5	5	5	5	9	24	17,280	5.06	28,800	8.44	34,560	10.13	1,038	1,826	2,861	
5	5	5	7	7	24	17,280	5.06	28,800	8.44	34,560	10.13	1,038	1,826	2,861	
5	5	5	7	9	26	18,720	5.49	31,200	9.14	37,440	10.97	1,128	2,068	3,349	
5	5	5	7	7	26	18,720	5.49	31,200	9.14	37,440	10.97	1,128	2,068	3,349	
5	5	5	5	12	27	19,440	5.70	32,400	9.50	38,640	11.32	1,174	2,230	3,524	
5	5	5	5	9	28	20,160	5.91	33,600	9.85	38,640	11.32	1,220	2,356	3,524	
5	5	5	7	9	28	20,160	5.91	33,600	9.85	38,640	11.32	1,220	2,356	3,524	
7	7	7	7	7	28	20,160	5.91	33,600	9.85	38,640	11.32	1,220	2,356	3,524	
5	5	5	7	12	29	20,700	6.07	34,500	10.11	38,640	11.32	1,267	2,487	3,524	
5	5	5	5	15	30	20,700	6.07	34,500	10.11	38,640	11.32	1,267	2,487	3,524	
5	5	5	7	9	30	20,700	6.07	34,500	10.11	38,640	11.32	1,267	2,487	3,524	
7	7	7	7	9	30	20,700	6.07	34,500	10.11	38,640	11.32	1,267	2,487	3,524	
5	5	5	9	12	31	21,700	6.07	34,500	10.11	38,640	11.32	1,267	2,487	3,524	
5	5	5	7	12	31	21,700	6.07	34,500	10.11	38,640	11.32	1,267	2,487	3,524	
5	5	5	7	15	32	22,700	6.07	34,500	10.11	38,640	11.32	1,267	2,487	3,524	
7	7	7	9	9	32	22,700	6.07	34,500	10.11	38,640	11.32	1,267	2,487	3,524	
5	5	5	9	9	32	22,700	6.07	34,500	10.11	38,640	11.32	1,267	2,487	3,524	
5	5	5	5	18	33	23,700	6.07	34,500	10.11	38,640	11.32	1,267	2,487	3,524	
5	5	5	7	12	33	23,700	6.07	34,500	10.11	38,640	11.32	1,267	2,487	3,524	
7	7	7	7	12	33	23,700	6.07	34,500	10.11	38,640	11.32	1,267	2,487	3,524	
5	5	5	9	15	34	24,700	6.07	34,500	10.11	38,640	11.32	1,267	2,487	3,524	
5	5	5	7	15	34	24,700	6.07	34,500	10.11	38,640	11.32	1,267	2,487	3,524	
7	7	7	7	15	34	24,700	6.07	34,500	10.11	38,640	11.32	1,267	2,487	3,524	
5	5	5	9	9	35	25,700	6.07	34,500	10.11	38,640	11.32	1,267	2,487	3,524	
5	5	5	7	12	35	25,700	6.07	34,500	10.11	38,640	11.32	1,267	2,487	3,524	
7	7	7	9	12	35	25,700	6.07	34,500	10.11	38,640	11.32	1,267	2,487	3,524	
5	5	5	7	15	36	26,700	6.07	34,500	10.11	38,640	11.32	1,267	2,487	3,524	
5	5	5	9	12	36	26,700	6.07	34,500	10.11	38,640	11.32	1,267	2,487	3,524	
7	7	7	12	12	36	26,700	6.07	34,500	10.11	38,640	11.32	1,267	2,487	3,524	
9	9	9	9	9	36	26,700	6.07	34,500	10.11	38,640	11.32	1,267	2,487	3,524	
5	5	5	9	18	37	27,700	6.07	34,500	10.11	38,640	11.32	1,267	2,487	3,524	
5	5	5	12	15	37	27,700	6.07	34,500	10.11	38,640	11.32	1,267	2,487	3,524	
7	7	7	7	18	37	27,700	6.07	34,500	10.11	38,640	11.32	1,267	2,487	3,524	
5	5	5	7	18	37	27,700	6.07	34,500	10.11	38,640	11.32	1,267	2,487	3,524	
7	7	7	9	12	37	27,700	6.07	34,500	10.11	38,640	11.32	1,267	2,487	3,524	
5	5	5	9	15	38	28,700	6.07	34,500	10.11	38,640	11.32	1,267	2,487	3,524	
7	7	7	9	15	38	28,700	6.07	34,500	10.11	38,640	11.32	1,267	2,487	3,524	
5	5	5	12	12	38	28,700	6.07	34,500	10.11	38,640	11.32	1,267	2,487	3,524	
9	9	9	9	15	38	28,700	6.07	34,500	10.11	38,640	11.32	1,267	2,487	3,524	
5	5	5	7	18	39	29,700	6.07	34,500	10.11	38,640	11.32	1,267	2,487	3,524	
7	7	7	12	12	39	29,700	6.07	34,500	10.11	38,640	11.32	1,267	2,487	3,524	
9	9	9	9	12	39	29,700	6.07	34,500	10.11	38,640	11.32	1,267	2,487	3,524	
5	5	5	9	18	40	30,700	6.07	34,500	10.11	38,640	11.32	1,267	2,487	3,524	
7	7	7	9	15	40	30,700	6.07	34,500	10.11	38,640	11.32	1,267	2,487	3,524	
5	5	5	12	12	40	30,700	6.07	34,500	10.11	38,640	11.32	1,267	2,487	3,524	
9	9	9	9	15	40	30,700	6.07	34,500	10.11	38,640	11.32	1,267	2,487	3,524	
7	7	7	12	12	40	30,700	6.07	34,500	10.11	38,640	11.32	1,267	2,487	3,524	
5	5	5	7	18	41	31,700	6.07	34,500	10.11	38,640	11.32	1,267	2,487	3,524	
7	7	7	9	12	41	31,700	6.07	34,500	10.11	38,640	11.32	1,267	2,487	3,524	
9	9	9	9	12	41	31,700	6.07	34,500	10.11	38,640	11.32	1,267	2,487	3,524	
5	5	5	9	15	41	31,700	6.07	34,500	10.11	38,640	11.32	1,267	2,487	3,524	
7	7	7	12	12	41	31,700	6.07	34,500	10.11	38,640	11.32	1,267	2,487	3,524	
9	9	9	9	12	41	31,700	6.07	34,500	10.11	38,640	11.32	1,267	2,487	3,524	
5	5	5	7	18	42	32,700	6.07	34,500	10.11	38,640	11.32	1,267	2,487	3,524	
7	7	7	15	15	42	32,700	6.07	34,500	10.11	38,640	11.32	1,267	2,487	3,524	
9	9	9	9	12	42	32,700	6.07	34,500	10.11	38,640	11.32	1,267	2,487	3,524	
5	5	5	9	15	42	32,700	6.07	34,500	10.11	38,640	11.32	1,267	2,487	3,524	
7	7	7	12	12	42	32,700	6.07	34,500	10.11	38,640	11.32	1,267	2,487	3,524	
9	9	9	9	12	42	32,700	6.07	34,500	10.11	38,640	11.32	1,267	2,487	3,524	
5	5	5	7	18	43	33,700	6.07	34,500	10.11	38,640	11.32	1,267	2,487	3,524	
7	7	7	15	15	43	33,700	6.07	34,500	10.11	38,640	11.32	1,267	2,487	3,524	
9	9	9	9	12	43	33,700	6.07	34,500	10.11	38,640	11.32	1,267	2,487	3,524	
5	5	5	9	15	43	33,700	6.07	34,500	10.11	38,640	11.32	1,267	2,487	3,524	
7	7	7	12	12	43	33,700	6.07	34,500	10.11	38,640	11.32	1,267	2,487	3,524	
9	9	9	9	12	43	33,700	6.07	34,500	10.11	38,640	11.32	1,267	2,487	3,524	
5	5	5	7	18	44	34,700	6.07	34,500	10.11	38,640	11.32	1,267	2,487	3,524	
7	7	7	15	15	44	34,700	6.07	34,500	10.11	38,640	11.32	1,267	2,487	3,524	
9	9	9	9	12	44	34,700	6.07	34,500	10.11	38,640	11.32	1,267	2,487	3,524	
5	5	5	9	15	44	34,700	6.07	34,500	10.11	38,640	11.32	1,267	2,487	3,524	
7	7	7	12	12	44	34,700	6.07	34,500	10.11	38,640	11.32	1,267	2,487	3,524	
9	9	9	9	12	44	34,700	6.07	34,500	10.11	38,640	11.32	1,267	2,487	3,524	
5	5	5	7	18	45	35,700	6.07	34,500	10.11	38,640	11.32	1,267	2,487	3,524	
7	7	7	15	15	45	35,700	6.07	34,500	10.11	38,640	11.32	1,267	2,487	3,524	
9	9	9	9	12	45	35,700	6.07	34,500	10.11	38,640	11.32				

R410A MULTI SPLIT

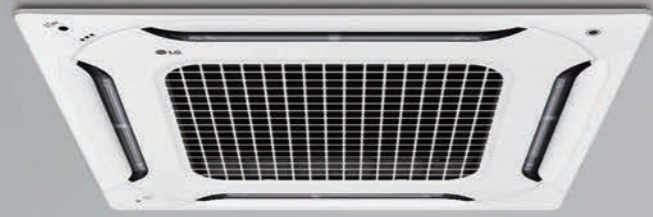

OUTDOOR				MU5M40 U44
Compressor	Type			Scroll
Capacity*	Cooling	Min. / Nom. / Max.	kW	1.3 / 11.2 / 14.7
	Heating	Min. / Nom. / Max.	kW	1.5 / 12.5 / 16.0
Low Temperature Capacity	Heating -7°C	Max.	kW	11.0
Power Input*	Cooling	Min. / Nom. / Max.	kW	0.4 / 3.3 / 5.5
	Heating	Min. / Nom. / Max.	kW	0.4 / 3.2 / 5.6
Running Current*	Cooling	Min. / Nom. / Max.	A	1.8 / 14.9 / 24.9
	Heating	Min. / Nom. / Max.	A	1.9 / 14.5 / 25.4
EER				3.40
COP				3.90
SEER				7.10
SCOP				4.00
Pdesign (@-10°C)			kW	8.90
Season Energy Label	Cooling / Heating (A+++ to D Scale)			A++ / A+
Annual Energy Consumption	Cooling / Heating			kWh 552 / 3,114
Airflow Rate		Nom.	m³/min	80
Sound Pressure Level	Cooling	Nom.	dB(A)	53
	Heating	Nom.	dB(A)	55
Sound Power Level	Cooling	Max.	dB(A)	67
Dimensions	W x H x D			mm 950 x 834 x 330
Net Weight				kg 73
Refrigerant	Type			R410A
	Charge		kg	3.4
	Additional Charge		g/m	20
	GWP			2087.5
Operation Range (Outdoor)	Cooling	Min. / Max.	°C DB	-10 / 48
	Heating	Min. / Max.	°C WB	-25 / 18
Power Supply				Ø / V / Hz 1 / 220-240 / 50
Power Supply Cable				No. x mm² 3C x 4.0
Transmission Cable				No. x mm² 4C x 0.75
Circuit Breaker				A 40
Piping Length Total				m 85
Piping Length per Branch		Max.	m	25
Piping Elevation Difference	IDU - ODU	Max.	m	15
	IDU - IDU	Max.	m	7.5
Piping Connection	Liquid		mm (inch) x No.	Ø6.35 (1/4) x 5
	Gas		mm (inch) x No.	Ø9.52 (3/8) x 5

※ For our policy of continuous product improvement, specification, design and features are subject to change without prior notice.

Note : 1. Capacities are based on the following conditions:

Cooling : - Indoor Temperature 27°C (80.6°F) DB / 19°C (66.2°F) WB - Outdoor Temperature 35°C (95°F) DB / 24°C (75.2°F) WB

Heating : - Indoor Temperature 20°C (68°F) DB / 15°C (59°F) WB - Outdoor Temperature 7°C (44.6°F) DB / 6°C (42.8°F) WB

Piping Length - Interconnecting Piping Length 7.5m - Level Difference of Zero.

2. * : See page "Combination Table".

3. Due to our policy of innovation some specifications may be changed without notification.

4. At least two indoor units should be connected.

5. Minimum combination capacity rate should be more than 40%.

6. This product contains fluorinated greenhouse gases. (R410A)



OUTDOOR				FM40AH U34	FM48AH U34	FM56AH U34
Compressor	Type	-		Scroll	Scroll	Scroll
	Capacity*	Cooling	Min. / Nom. / Max. kW	2.8 / 12.3 / 15.4	3.3 / 14.1 / 17.0	4.0 / 15.5 / 18.5
Capacity*	Heating	Min. / Nom. / Max. kW	3.1 / 13.5 / 16.2	3.7 / 16.0 / 17.3	4.5 / 17.4 / 18.8	
	Low Temperature Capacity	Heating	Max. kW	12.5	14.5	15.5
Power Input*	Cooling	Min. / Nom. / Max. kW	0.82 / 2.42 / 4.90	0.96 / 3.12 / 5.30	1.18 / 3.87 / 5.60	
	Heating	Min. / Nom. / Max. kW	0.89 / 2.87 / 5.10	1.06 / 3.76 / 5.40	1.29 / 4.34 / 5.80	
Running Current*	Cooling	Min. / Nom. / Max. A	3.7 / 11.0 / 22.2	4.4 / 14.1 / 24.0	5.3 / 17.5 / 25.4	
	Heating	Min. / Nom. / Max. A	4.0 / 13.0 / 23.1	4.8 / 17.0 / 24.5	5.9 / 19.7 / 26.3	
EER			5.08	4.51	4.01	
COP			4.70	4.25	4.01	
SEER			7.40	7.20	6.90	
SCOP			4.20	4.20	4.20	
Pdesign(@-10°C)			8.6	9.5	9.5	
Seasonal Energy Label (A++ to E Scale)	Cooling / Heating	-	- / -	- / -	- / -	
Annual Energy Consumption	Cooling / Heating	kWh	981 / 2,867	1,167 / 3,167	1,348 / 3,167	
Air Flow Rate	Nom.	m ³ /min x No.	110	110	110	
Sound Pressure Level	Cooling	Nom. dB(A)	51	53	53	
	Heating	Nom. dB(A)	53	55	55	
Sound Power Level	Cooling	Max. dB(A)	69	71	73	
	Heating	Max. dB(A)	70	72	74	
Dimensions	W x H x D	mm	950 x 1,380 x 330	950 x 1,380 x 330	950 x 1,380 x 330	
Net Weight		kg	87	87	87	
Refrigerant	Type		R410A	R410A	R410A	
	Charge		4,200	4,200	4,200	
	Additional Charging Volume		20	20	20	
	GWP (Global Warming Potential)		2,087.5	2,087.5	2,087.5	
	t-CO ₂ eq		8.768	8.768	8.768	
Operation Range (Outdoor)	Cooling	Min. / Max. °C DB	-10 / 48	-10 / 48	-10 / 48	
	Heating	Min. / Max. °C WB	-25 / 18	-25 / 18	-25 / 18	
Power Supply		Ø / V / Hz	1 / 220-240 / 50	1 / 220-240 / 50	1 / 220-240 / 50	
Power Supply Cable		No. x mm ²	3C x 4.0	3C x 4.0	3C x 4.0	
Transmission Cable	ODU-BD	No. x mm ²	4C x 1.25	4C x 1.25	4C x 1.25	
	BD-IDU	No. x mm ²	4C x 0.75	4C x 0.75	4C x 0.75	
Circuit Breaker		A	40	40	40	
Max Piping Length	Total Piping (Main+Total Branch)	m	125	135	145	
	Main Piping	m	55	55	55	
	Total Branch Piping	m	70	80	90	
	Each Branch Piping	m	15	15	15	
Piping Elevation Difference	IDU-ODU	Max. m	30	30	30	
	IDU-IDU	Max. m	15	15	15	
Piping Connections	Liquid	mm (inch) x No.	Ø9.52 x 1	Ø9.52 x 1	Ø9.52 x 1	
	Gas	mm (inch) x No.	Ø19.05 x1	Ø19.05 x1	Ø19.05 x1	

※ For our policy of continuous product improvement, specification, design and features are subject to change without prior notice.
 Note : 1. Capacities are based on the following conditions:
 Cooling : - Indoor Temperature 27°C (80.6°F) DB / 19°C (66.2°F) WB - Outdoor Temperature 35°C (95°F) DB / 24°C (75.2°F) WB
 Heating : - Indoor Temperature 20°C (68°F) DB / 15°C (59°F) WB - Outdoor Temperature 7°C (44.6°F) DB / 6°C (42.8°F) WB
 Piping Length - Interconnecting Piping Length 7.5m - Level Difference of Zero.
 2. * : See page "Combination Table".
 3. Due to our policy of innovation some specifications may be changed without notification.
 4. At least two indoor units should be connected.
 5. Minimum combination capacity rate should be more than 40%.
 6. This product contains fluorinated greenhouse gases. (R410A)



OUTDOOR				FM41AH U34	FM49AH U34	FM57AH U34
Compressor	Type	-		Scroll	Scroll	Scroll
	Capacity*	Cooling	Min. / Nom. / Max. kW	2.8 / 12.3 / 15.4	3.3 / 14.1 / 17.0	4.0 / 15.5 / 18.5
Capacity*	Heating	Min. / Nom. / Max. kW	3.1 / 13.5 / 16.2	3.7 / 16.0 / 17.3	4.5 / 17.4 / 18.8	
	Low Temperature Capacity	Heating	Max. kW	12.5	14.5	15.5
Power Input*	Cooling	Min. / Nom. / Max. kW	0.82 / 2.42 / 4.90	0.96 / 3.12 / 5.30	1.18 / 3.87 / 5.60	
	Heating	Min. / Nom. / Max. kW	0.89 / 2.87 / 5.10	1.06 / 3.76 / 5.40	1.29 / 4.34 / 5.80	
Running Current*	Cooling	Min. / Nom. / Max. A	1.2 / 3.6 / 7.4	1.4 / 4.7 / 8.0	1.8 / 5.8 / 8.4	
	Heating	Min. / Nom. / Max. A	1.3 / 4.3 / 7.7	1.6 / 5.7 / 8.1	1.9 / 6.5 / 8.7	
EER			5.08	4.51	4.01	
COP			4.70	4.25	4.01	
SEER			7.40	7.20	6.90	
SCOP			4.20	4.20	4.20	
Pdesign(@-10°C)			8.6	9.5	9.5	
Seasonal Energy Label (A++ to E Scale)	Cooling / Heating	-	- / -	- / -	- / -	
Annual Energy Consumption	Cooling / Heating	kWh	981 / 2,867	1,167 / 3,167	1,348 / 3,167	
Air Flow Rate	Nom.	m ³ /min x No.	110	110	110	
Sound Pressure Level	Cooling	Nom. dB(A)	51	53	53	
	Heating	Nom. dB(A)	53	55	55	
Sound Power Level	Cooling	Max. dB(A)	69	71	73	
	Heating	Max. dB(A)	70	72	74	
Dimensions	W x H x D	mm	950 x 1,380 x 330	950 x 1,380 x 330	950 x 1,380 x 330	
Net Weight		kg	87	87	87	
Refrigerant	Type		R410A	R410A	R410A	
	Charge		4,200	4,200	4,200	
	Additional Charging Volume		20	20	20	
	GWP (Global Warming Potential)		2,087.50	2,087.50	2,087.50	
	t-CO ₂ eq		8.768	8.768	8.768	
Operation Range (Outdoor)	Cooling	Min. / Max. °C DB	-10 / 48	-10 / 48	-10 / 48	
	Heating	Min. / Max. °C WB	-25 / 18	-25 / 18	-25 / 18	
Power Supply		Ø / V / Hz	3 / 380-415 / 50	3 / 380-415 / 50	3 / 380-415 / 50	
Power Supply Cable		No. x mm ²	5C x 2.5	5C x 2.5	5C x 2.5	
Transmission Cable	ODU-BD	No. x mm ²	4C x 1.25	4C x 1.25	4C x 1.25	
	BD-IDU	No. x mm ²	4C x 0.75	4C x 0.75	4C x 0.75	
Circuit Breaker		A	20	20	20	
Max Piping Length	Total Piping (Main+Total Branch)	m	125	135	145	
	Main Piping	m	55	55	55	
	Total Branch Piping	m	70	80	90	
	Each Branch Piping	m	15	15	15	
Piping Elevation Difference	IDU-ODU	Max. m	30	30	30	
	IDU-IDU	Max. m	15	15	15	
Piping Connections	Liquid	mm (inch) x No.	Ø9.52 x 1	Ø9.52 x 1	Ø9.52 x 1	
	Gas	mm (inch) x No.	Ø19.05 x1	Ø19.05 x1	Ø19.05 x1	

※ For our policy of continuous product improvement, specification, design and features are subject to change without prior notice.
 Note : 1. Capacities are based on the following conditions:
 Cooling : - Indoor Temperature 27°C (80.6°F) DB / 19°C (66.2°F) WB - Outdoor Temperature 35°C (95°F) DB / 24°C (75.2°F) WB
 Heating : - Indoor Temperature 20°C (68°F) DB / 15°C (59°F) WB - Outdoor Temperature 7°C (44.6°F) DB / 6°C (42.8°F) WB
 Piping Length - Interconnecting Piping Length 7.5m - Level Difference of Zero.
 2. * : See page "Combination Table".
 3. Due to our policy of innovation some specifications may be changed without notification.
 4. At least two indoor units should be connected.
 5. Minimum combination capacity rate should be more than 40%.
 6. This product contains fluorinated greenhouse gases. (R410A)

Optimized Air Flow for Cooling & Heating

During cooling operation, the vane adjusts upwards to direct air flow toward the ceiling. During heating operation, the vane directs the air flow toward the floor to balance out the room temperature. A wireless controller is included with the indoor console unit.

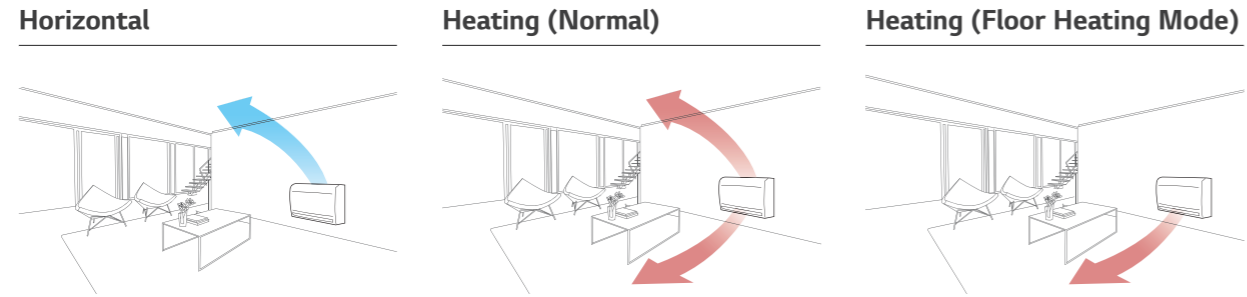

Quick Floor Heating

Console air conditioners offer a fast and powerful performance. Using the floor heating mode, console air conditioners provide faster floor heating and help to reach the desired temperature quickly.

	Company A	Electric Heater	LG	LG Floor Heating Mode
 Vertical				
Horizontal				
Lead Time for Heating (13°C ~ 21°C)	12 minutes 30 seconds	50 minutes	9 minutes 30 seconds	8 minutes 40 seconds

※ Test Condition : Target Temp 23°C, Indoor Room : 13°C-, Outdoor Room : 7°C

5-Step Vane Control

There are 5 different stages to control air flow direction.

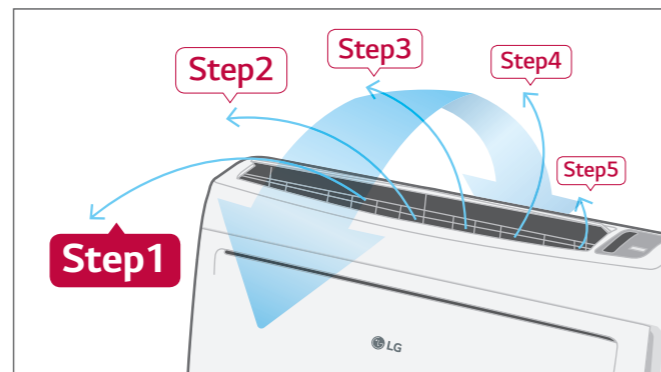

	CAPACITY (kW)	2.6	3.5	5.3
Console		CQ09 NAO	CQ12 NAO	CQ18 NAO

Console

INDOOR				CQ09 NAO
Capacity	Cooling / Heating	Nom.	kW	2.6 / 2.9
Power Input		Nom.	W	20
Running Current		Nom.	A	0.6
Power Supply			Ø / V / Hz	1 / 220-240 / 50
Air Flow Rate		H / M / L	m ³ /min	8.5 / 6.7 / 5.0
Sound Pressure	Cooling	H / M / L	dB(A)	38 / 32 / 27
Sound Power	Cooling	Max.	dB(A)	53
Dehumidification Rate			l/h	1.2
Dimensions	Body	W x H x D	mm	700 x 600 x 210
Net Weight	Body		kg	14.0
Piping	Liquid		mm (inch)	Ø6.35 (1/4)
Connection	Gas		mm (inch)	Ø9.52 (3/8)

INDOOR				CQ12 NAO	CQ18 NAO
Capacity	Cooling / Heating	Nom.	kW	3.5 / 3.9	5.3 / 5.8
Power Input		Nom.	W	20	40
Running Current		Nom.	A	0.6	0.7
Power Supply			Ø / V / Hz	1 / 220-240 / 50	1 / 220-240 / 50
Air Flow Rate		H / M / L	m ³ /min	9.0 / 6.9 / 5.2	10.1 / 8.6 / 7.2
Sound Pressure	Cooling	H / M / L	dB(A)	39 / 32 / 27	44 / 39 / 35
Sound Power	Cooling	Max.	dB(A)	56	60
Dehumidification Rate			l/h	1.4	2.3
Dimensions	Body	W x H x D	mm	700 x 600 x 210	700 x 600 x 210
Net Weight	Body		kg	14.0	14.0
Piping	Liquid		mm (inch)	Ø6.35 (1/4)	Ø6.35 (1/4)
Connection	Gas		mm (inch)	Ø9.52 (3/8)	Ø12.7 (1/2)

※ R32 Console compatible for both SCAC and MULTI will be 2nd half of 2021.

Note : 1. Capacities are based on the following conditions :

Cooling : - Indoor Temperature 27°C (80.6°F) DB / 19°C (66.2°F) WB - Outdoor Temperature 35°C (95°F) DB / 24°C (75.2°F) WB

Heating : - Indoor Temperature 20°C (68°F) DB / 15°C (59°F) WB - Outdoor Temperature 7°C (44.6°F) DB / 6°C (42.8°F) WB

Piping Length - Interconnecting Piping Length 7.5m - Level Difference of Zero.

2. Definition of Power Input Nominal conditions - Performance tested under EN14511

3. Due to our policy of innovation some specifications may be changed without notification.

4. This product contains fluorinated greenhouse gases. (R410A)

Cassette Panel

The Independent Vane Operation makes desired and comfortable air flow.



Model Name & Applied Products

4 Way Cassette (Mini, 570x570)
PT-QAGW0
PT-QCHW0
PT-UQC

2 Way Cassette
PT-USC

1 Way Cassette (Grill Type)
PT-UAHG0
PT-UAHW0

1 way cassette (Air purification)
PT-UPHG0

Key Features

- Independent vane operation uses separate motors, making it possible to control all 1, 2, and 4 vanes independently.
- The detachable corner design makes it easy to adjust the hanger during installation and to check for leakages in the drain pipe and refrigerant pipes.

Compact and Stylish Design

- New 4 way cassette panel adapted unibody shape and matching with the ceiling.
- Panel size is fit into the ceiling tile.

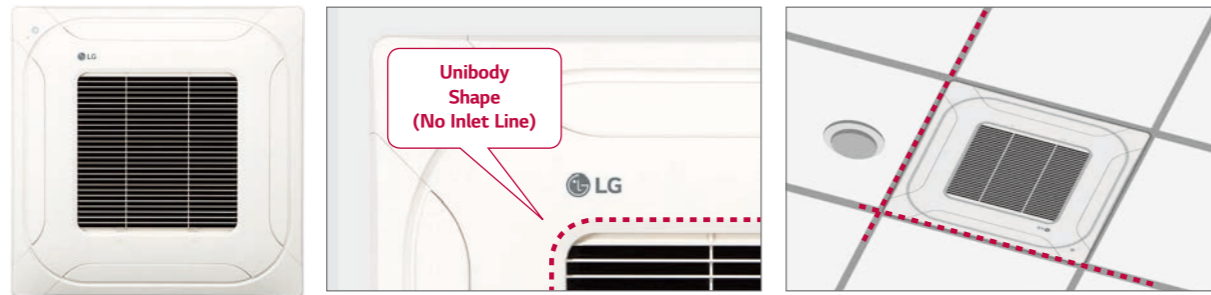

Specification

Model	Suction Type	Color (RAL)	Gloss	Weight (kg)	Dimension (mm)			Applied Model Capacity (kW)*						
					W	H	D	Single Split		Multi Split		Multi V		
								R32	R410A	R32	R410A	R32	R410A	
4 Way	PT-QCHW0	Grill	Morning Fog (RAL 9001)	X	3.0	620	35	620	2.5-5.0	2.5-5.0	1.5-5.3	1.5-5.3	1.6-6.2	1.6-6.2
	PT-UQC	Grill	Morning Fog (RAL 9001)	X	3.0	700	22	700	2.5-5.0	2.5-5.0	1.5-5.3	1.5-5.3	1.6-6.2	1.6-6.2
	PT-QAGW0	Grid	White (RAL 9003)	X	2.9	620	35	620	2.5-5.0	2.5-5.0	1.5-5.3	1.5-5.3	1.6-6.2	1.6-6.2
2 Way	PT-USC	Grill	Morning Fog (RAL 9001)	X	4.7	1,100	28	690					2.8-7.1	2.8-7.1
	PT-UAHG0	Grill	White (RAL 9003)	O	3.9	1,160	34	500			2.6-3.5	2.6-3.5	2.2-3.6	2.2-3.6
	PT-UAHW0	Grill	White (RAL 9003)	X	3.3	1,100	34	500			2.6-3.5	2.6-3.5	2.2-3.6	2.2-3.6
1 Way	PT-UPHG0	Grill	White (RAL 9003)	O	4.1	1,160	34	500			2.6-3.5	2.6-3.5	2.2-3.6	2.2-3.6

* Based on cooling capacity
※ O : Applied, - : Not applied

Dual Vane Cassette Panel



Model Name
PT-AAGW0
PT-AFGW0

Key Features

Model	Function					
	Dual Vane	Wi-Fi	Floor Temperature Sensor	Air Purification	Elevating Grille	Human Detection Sensor
PT-AAGW0	O	Optional	Optional	X	X	Optional
PT-AFGW0	O	Optional	Optional	Optional (Dust Sensor, Tact Switch)	X	Optional

Specification

Model	Suction Type	Color (RAL)	Gloss	Weight (kg)	Dimension (mm)		
					W	H	D
PT-AAGW0	Grid	White (RAL 9003)	-	7.1	950	35	950
PT-AFGW0	Grid	White (RAL 9003)	-	7.5	950	35	950

Air Purification Kit

Model	Image	Model name	Dielectric Dust collecting filter	Photocatalytic Deodorizing filter	HVPS	Ionizer
Air cleaning kit		PTAHMPO	O	O	O	O
		PTAHTPO	O	O	O	O

Cassette Cover

Cover in case of exposed cassette installation.

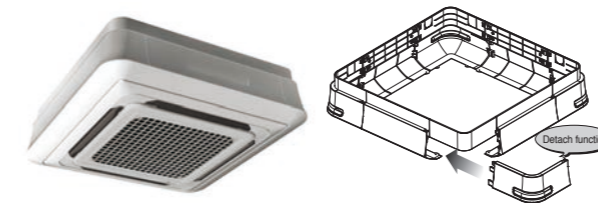

Model Name
PTDCM / PTDCQ

Applied Products

4 Way Cassette (for chassis TB, TQ, TR)

Included Parts

- Cover A, Cover B
- Cover C, Cover D
- Screws
- Installation Manual

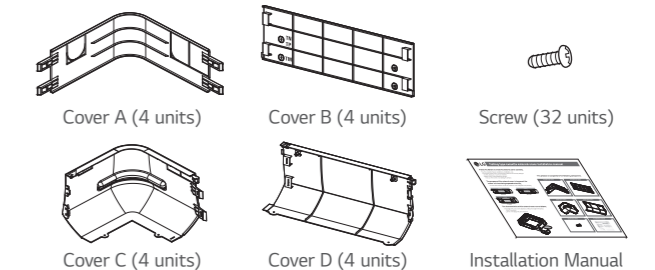

Key Features

- Specially designed for indoor unit
- Covers the side area of cassette
- Gives elegant looks
- Light weight

Specification

Model	Front Panel		Weight (kg)		Dimensions (mm)		
			NET	Gross	W	H	D
PTDCM	PT-AAGW0 PT-AFGW0	TB	5.9	8.8	1,157	1,157	268
		TR	5.0	7.2	907	907	268
PTDCQ	PT-UQC	TQ	5.0	7.2	907	907	310

LG Wi-Fi Modem

Control conditioners by using internet devices as Android or iOS smartphones.



PWFMD200

Features

- User can enjoy anytime, anywhere access with Wi-Fi equipped device through LG's ThinQ mobile app.
- This allows the user to access the unit remotely to switch unit on or off before or after leaving the vicinity.
- LG's exclusive Home Appliances control app (LG ThinQ) is available.
- Simple operation for various functions.
 - On / Off
 - Operation Mode
 - Current / Set Temperature
 - Fan Speed
 - Vane Control ¹⁾
 - Reservation (Sleep, Weekly On / Off)
 - Energy Monitoring ²⁾
 - Filter Management
 - Error Check
 - Air Purify ³⁾

Model Name	PWFMD200
Size (W x H x D, mm)	48 x 68 x 14
Interfaceable Products	System Air Conditioner ³⁾
Connection Type	Indoor unit 1:1
Communication Frequency	2.4 GHz
Wireless Standards	IEEE 802.11b/g/n
Mobile Application	LG ThinQ (Android v4.1(Jellybean) or higher, iPhone iOS 9.0 or higher)
Optional Extension Cable	PWYREW000 (10m extension)

Note : 1. Functionality may be different according to each IDU model.
 2. User interface of application shall be revised for its design and contents improvement.
 3. Application is optimized for smartphone use, so it may not be well functioning with tablet devices.
 1) Vane Control may not be possible according to the type of Indoor unit.
 2) LG Centralized controller and PDI installation is required for this function.
 3) For the compatibility with Indoor unit, please contact regional LG office.

Overview

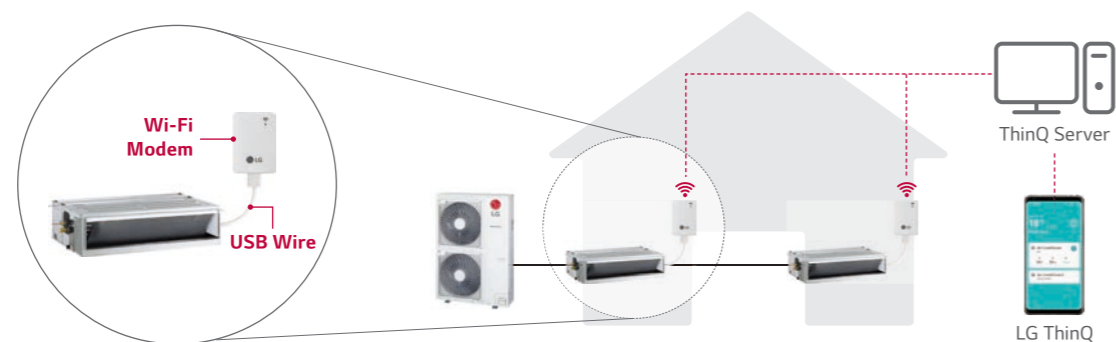

※ Search "LG ThinQ" on Google market or Appstore then download the app.
 ※ Internet service with Wi-Fi connection has to be available.

Standard Wired Remote Controller



Standard III
PREMTB100

Standard III
PREMTBB10



Standard II
PREMTB001

Standard II
PREMTBB01

Model Name	PREMTB100 PREMTBB10	PREMTB001 PREMTBB01
Operation Mode	On / Off, Fan Speed Control, Temperature Setting	
Mode Change	Cooling, Heating, Auto, Dehumidification, Fan	
Auto Swing / Vane Control	•	•
Reservation	Simple, Sleep, On / Off, Weekly, Holiday	
Time Display	•	•
Electrical Failure Compensation	•	•
Child Lock	•	•
Operation Status LED	•	•
Indoor Temperature Display	•	•
Wireless Remote Controller Receiver	-	•
Size (W x H x D, mm)	120 x 120 x 16	120 x 121 x 16
Backlight	•	•

Remote Controller



PQWRHQ0FDB

※ Only some of controllers have back light feature.

PI 485

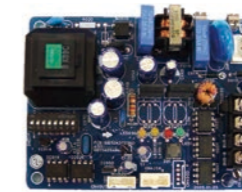

PMNFP14A1

Power : Single phase AC 220V 50/60Hz
 Max. no of the indoor units that can be connected : 64 UNITS
 Model applied : RAC / Multi / Single / Thermo V

※ Refer to each product PDB for applicable models.

Dry Contact



PDRYCB000

PDRYCB400



PDRYCB320

PDRYCB500

※ Refer to each product PDB for applicable models.

Model	PDRYCB000	PDRYCB400	PDRYCB320	PDRYCB500
Contact Point	1 Control Point	2 Control Point	8 Control Point	Modbus RTU
Power Input	AC 220V from outside power source	DC 5V & 12V from indoor unit PCB	DC 5V & 12V from indoor unit PCB	DC 5V & 12 V from indoor unit PDB
Voltage / Non Voltage Input	-	•	•	-
On / Off Control	•	•	•	•
Lock / Unlock	•	•	•	•
Fan Speed Setting	-	-	-	•
Thermo Off	-	•	•	-
Energy Saving	-	•	-	-
Temperature Setting	-	•	•	•
Error Monitoring	•	•	•	•
Operation Monitoring	•	•	•	•

Distributor Box

Easy installation using the range of Distributor Boxes. Various distributors can make much easier installation for any sites.



PMBD3620 (2 Indoors) PMBD3630 (3 Indoors) PMBD3640 (4 Indoors)

Features

- Distribution of refrigerant to various indoor units.
- 3 models (2, 3, 4 Indoor Units)
- EEV included
- Controlling PCB inside the unit
- Internally insulated (Prevents any chances of drainage)
- Flare joints for easy and clean installation
- Compact design (Low height)
- Flexible installation



No Brazing

Just Flaring

Specification

Model Name		PMBD3620	PMBD3630	PMBD3640	
Connectable Indoor Units	Number of Indoor Units	1 - 2	1 - 3	1 - 4	
	Capacity	5k / 7k / 9k / 12k / 18k / 24k	5k / 7k / 9k / 12k / 18k / 24k	5k / 7k / 9k / 12k / 18k / 24k	
Power Source	Ø / V / Hz	1 / 220-240 / 50	1 / 220-240 / 50	1 / 220-240 / 50	
Power Consumption	W	10	10	10	
Running Current	A	0.05	0.05	0.05	
Dimensions	W x H x D	302 x 143 x 252 (11.9 x 5.6 x 9.9)	302 x 143 x 252 (11.9 x 5.6 x 9.9)	302 x 143 x 252 (11.9 x 5.6 x 9.9)	
	Net Weight	kg/lb	4.8 / 10.6	4.9 / 10.8	5 / 11
Piping Connection (To Outdoor Unit)	Liquid	mm (inch)	Ø9.52 (3/8)	Ø9.52 (3/8)	Ø9.52(3/8)
	Gas	mm (inch)	Ø19.05 (3/4)	Ø19.05 (3/4)	Ø19.05(3/4)
Piping Connection (To Indoor Unit)	Liquid	mm (inch)	Ø6.35 (1/4) x 2EA	Ø6.35 (1/4) x 3EA	Ø6.35 (1/4) x 4EA
	Gas	mm (inch)	Ø9.52 (3/8) x 2EA	Ø9.52 (3/8) x 3EA	Ø9.52 (3/8) x 4EA
Accessories	Hanger (Bracket)	EA	4	4	4
	Screw	EA	8	8	8
	Manual	EA	1	1	1

※ For our policy of continuous product improvement, specification, design and features are subject to change without prior notice.
 Note : 1. The piping connection must be suit the piping sizes of the indoor unit which will be connected.
 (If need, use the connector which is included in the indoor unit)
 2. The BD should be installed inside the building.

Y Branch and Branch Kit

Easy installation using the range of Distributor Boxes. Various distributors can make much easier installation for any sites.



PMBL5620 (2 units) PMBL1203F0 (3 units)

Features

- Y Branch and Branch kit make Multi FDX installation much easier.
- Y Branch and Branch kit for both gas and liquid are provided.
- Insulation material is also provided for covering the branches.

Application

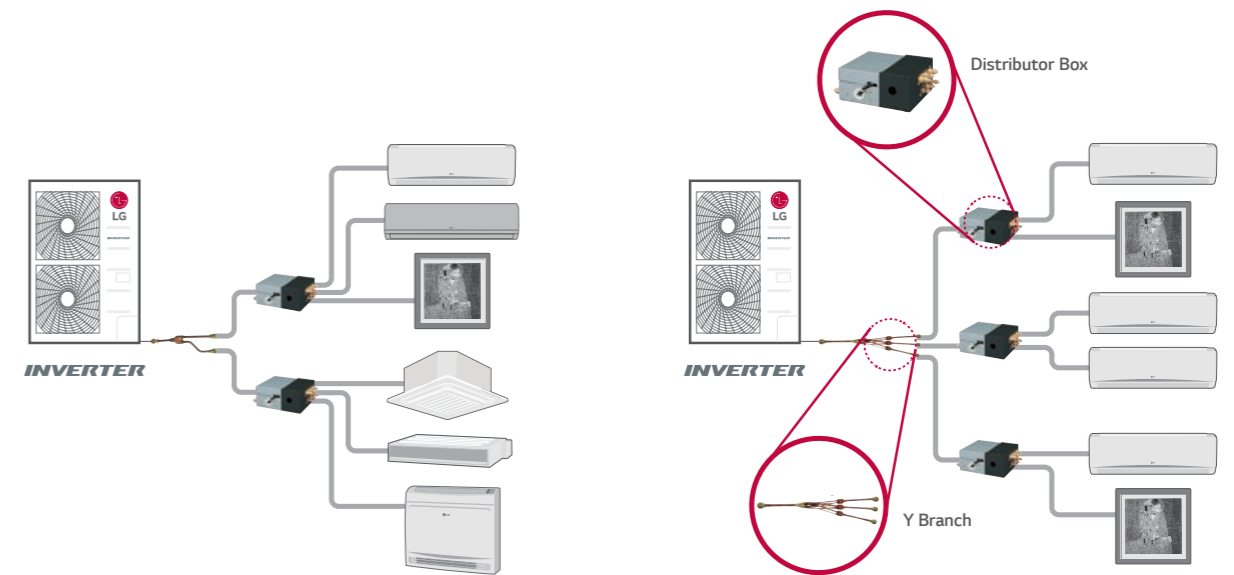

Accessory Model Name

(Unit : mm)

Model Name	No. of Branch distribution units	Applicable Model	Specification	
			Gas	Liquid
PMBL5620	2 Units	1Ø, 3Ø		
PMBL1203F0	3 Units	1Ø, 3Ø		

146 - 275 COMMERCIAL

SINGLE SPLIT

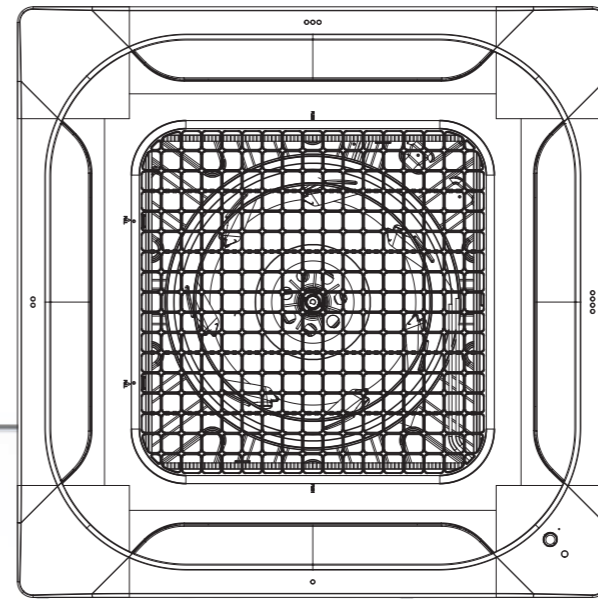

H-INVERTER (R32)

STANDARD INVERTER (R32)

		H-INVERTER (R32)						STANDARD INVERTER (R32)								
kBTu/h	Type kW	Ceiling Mounted Cassette	Ceiling Concealed Duct		Ceiling Suspended	ODU		Ceiling Mounted Cassette	Round Cassette	Ceiling Concealed Duct		Ceiling Suspended	Wall Mounted	Console	ODU	
			Mid Static	Low Static		1Ø	3Ø			Mid Static	Low Static				1Ø	3Ø
9	2.5															
12	3.4															
18	5.0															
24	6.8															
30	8.0															
36	9.5															
42	12.0															
48	13.4															
60	14.6															
70	20.0															
85	25.0															

COMPACT INVERTER (R32)

STANDARD INVERTER (R410A)

		COMPACT INVERTER (R32)						STANDARD INVERTER (R410A)			
kBTu/h	Type kW	Ceiling Mounted Cassette	Ceiling Concealed Duct		Ceiling Suspended	Wall Mounted	ODU	Ceiling Concealed Duct (High Static)	Floor Standing	ODU	
			Mid Static	Low Static						1Ø	3Ø
9	2.5										
12	3.4										
18	5.0										
24	6.8										
30	8.0										
36	9.5										
42	12.0										
48	13.4										
60	14.6										
70	20.0										
85	25.0										

SINGLE SPLIT



CATEGORY		H-INVERTER (R32)								
kBTu/h		9	12	18	24	30	36	42	48	60
kW		2.5	3.4	5.0	6.8	8.0	9.5	12.0	13.4	14.6
Supreme Energy Efficiency	BLDC Comp & Fan Motor	•	•	•	•	•	•	•	•	•
	Eurovent Certi.	•	•	•	•	•	•	•	•	•
	High Level SEER / SCOP	•	•	•	•	•	•	•	•	•
	Variable Voltage Control	•	•	•	•	•	•	•	•	•
	Wide Louver Fin	•	•	•	•	•	•	•	•	•
	Optimised Heat Exchanger Path			•	•	•	•	•	•	•
	Power Saving Start up	•	•	•	•	•	•	•	•	•
	Peak Current Control			•	•	•	•	•	•	•
	Mode Lock	•*	•*	•	•	•	•	•	•	•
	Standby Mode	•	•	•	•	•	•	•	•	•
Comfort Environment	Comfort Cooling with Humidity sensor**			•	•	•	•	•	•	•
	Night Silent Operation			•	•	•	•	•	•	•
	Continuous Cooling Operation	•	•	•	•	•	•	•	•	•
High Performance & Reliability	Quick & Reliable Operation	•	•	•	•	•	•	•	•	•
	R1 Compressor						•	•	•	•
	Corrosion resistance Black Fin	•	•	•	•	•	•	•	•	•
	Long Pipe Installation	•	•	•	•	•	•	•	•	•
Convenient Control System	LG ThinQ***	•	•	•	•	•	•	•	•	•
	Easy Control (PI-485 Connection)	•	•	•	•	•	•	•	•	•
	1 Point External Input****	•	•	•	•	•	•	•	•	•
	Forced Cooling Operation			•	•	•	•	•	•	•
	Mobile LG MV	•	•	•	•	•	•	•	•	•
	Weekly Program*****	•	•	•	•	•	•	•	•	•
Enhanced Application	Synchro function									
	Connection with AHU			•	•	•	•	•	•	•



* With controller PREMTB001 / PREMTBB01 / PREMTB100 / PREMTBB10
 ** Available only for Ceiling Mounted cassette (840 x 840), Ceiling Suspended, Console models.
 *** Available with LG Wi-Fi modem(PWFMDD200) and it should be connected to the indoor unit.
 **** Available except for Wall Mounted Unit.
 ***** Weekly program is available with wired remote controller.



CATEGORY		STANDARD INVERTER (R32)									COMPACT INVERTER (R32)				
kBTu/h		9	12	18	24	30	36	42	48	60	18	24	30	36	
kW		2.5	3.4	5.0	6.8	8.0	9.5	12.0	13.4	14.6	5.0	6.8	8.0	9.5	
Supreme Energy Efficiency	BLDC Comp & Fan Motor	•	•	•	•	•	•	•	•	•	•	•	•	•	
	Eurovent Certi.	•	•	•	•	•	•	•	•	•	•	•	•	•	
	High Level SEER / SCOP	•	•	•	•	•	•	•	•	•	•	•	•	•	
	Variable Voltage Control	•	•	•	•	•	•	•	•	•	•	•	•	•	
	Wide Louver Fin	•	•	•	•	•	•	•	•	•	•	•	•	•	
	Optimised Heat Exchanger Path				•	•	•	•	•	•		•	•	•	
	Power Saving Start up	•	•	•	•	•	•	•	•	•	•	•	•	•	
	Peak Current Control				•	•	•	•	•	•		•	•	•	
	Mode Lock	•*	•*	•	•	•	•	•	•	•	•	•*	•	•	•
	Standby Mode	•	•	•	•	•	•	•	•	•	•	•	•	•	•
Comfort Environment	Comfort Cooling with Humidity sensor**	•	•	•	•	•	•	•	•	•	•	•	•	•	
	Night Silent Operation				•	•	•	•	•	•		•	•	•	
	Continuous Cooling Operation	•	•	•	•	•	•	•	•	•					
High Performance & Reliability	Quick & Reliable Operation	•	•	•	•	•	•	•	•	•	•	•	•	•	
	R1 Compressor										•	•	•	•	
	Corrosion Resistance Black Fin	•	•	•	•	•	•	•	•	•	•	•	•	•	
	Long Pipe Installation	•	•	•	•	•	•	•	•	•	•	•	•	•	
Convenient Control System	LG ThinQ***	•	•	•	•	•	•	•	•	•	•	•	•	•	
	Easy Control (PI-485 Connection)	•	•	•	•	•	•	•	•	•	•	•	•	•	
	1 Point External Input****	•	•	•	•	•	•	•	•	•	•	•	•	•	
	Forced Cooling Operation				•	•	•	•	•	•		•	•	•	
	Mobile LG MV	•	•	•	•	•	•	•	•	•	•	•	•	•	
	Weekly Program*****	•	•	•	•	•	•	•	•	•	•	•	•	•	
Enhanced Application	Synchro Function										•	•	•	•	
	Connection with AHU												•	•	•

* With controller PREMTB001 / PREMTBB01 / PREMTB100 / PREMTBB10
 ** Available only for Ceiling Mounted cassette (840 x 840), Ceiling Suspended, Console models.
 *** Available with LG Wi-Fi modem(PWFMDD200) and it should be connected to the indoor unit.
 **** Available except for Wall Mounted Unit.
 ***** Weekly program is available with wired remote controller.

Triple Line-up for On-site Customization

Customer has various options to select suitable model as desired condition.

H-INVERTER	STANDARD	COMPACT
High Performance  (13 sets) (12 sets) (7 sets)	Wide Application  (13 sets) (15 sets) (11 sets) (4 sets) (3 sets) (7 sets)	Compact Size  (4 sets) (6 sets) (4 sets) (2 sets)
Total 32 Sets	Total 53 Sets	Total 16 Sets

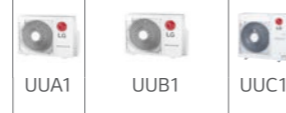
Line-up	Description	9k (2.5kW)	12k (3.4kW)	18k (5.0kW)	24k (6.8kW)	30k (8.0kW)	36k (9.5kW)	42k (12.0kW)	48k (13.4kW)	60k (14.6kW)
H-INVERTER (R32) SEER A+++ - A++ High Performance - Suitable for high quality functions - Maximum pipe length up to 85m* - Floor Detection Sensor (Default) - Wide Cooling operation range (-20°C ~ 52°C) & 100% Capacity at 48°C* - Wide Heating operation range (-25°C ~ 18°C) & 100% Capacity at -15°C*										
STANDARD INVERTER (R32) SEER A++ - A+ Wide Commercial Applications - Suitable for wide commercial applications - Maximum pipe length up to 85m* - Synchro Function over 36k Model (Max. 4 IDUs) - Wi-Fi Modem and Floor Detection Sensor (Option) - Wide Cooling operation range (-20°C ~ 52°C)* - Wide Heating operation range (-25°C ~ 18°C)*										
COMPACT INVERTER (R32) SEER A++ - A Compact & Cost Effective - Suitable for busy environments and small shops - Very compact and easy to install - Maximum pipe length up to 50m* - Wi-Fi Modem and Floor Detection Sensor (Option) - Cooling operation range (-20°C ~ 50°C)* - Heating operation range (-15°C ~ 18°C)*										

* This specification can be different as per each model or combination.

H-Inverter : High Performance with lower energy consumption



Capacity
17% ↑
 at -15°C

Energy Saving
SEER class : A+++ - A++

High heating capacity at low ambient condition
17% higher than standard

High cooling capacity at overload condition
7% higher than standard

* This specification can be different as per each model or combination.

Standard : Wide Application with diverse design range

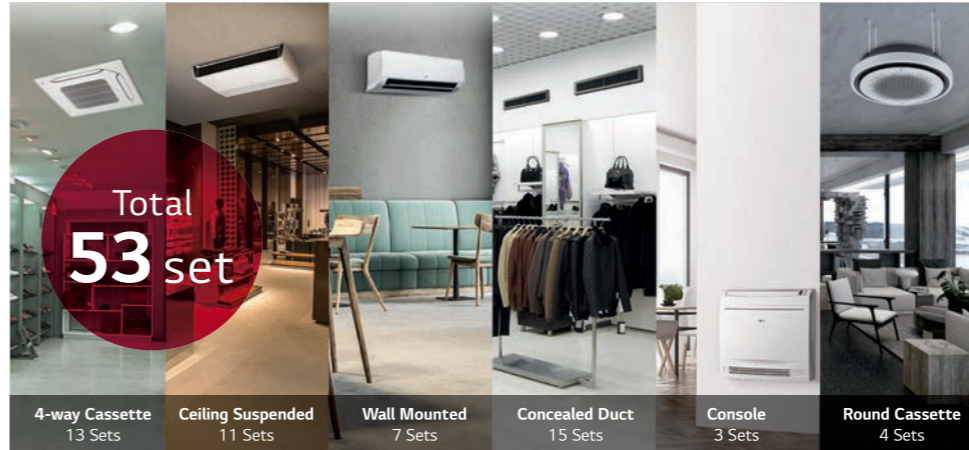

Total
53 set

Flexible Installation
Max pipe length up to 85m*

Wide Operation Range
Cooling (DB) : -20 ~ 52 °C*
Heating (WB) : -25 ~ 18 °C*

Energy Saving
SEER class : A+++ - A++

4-way Cassette 13 Sets | Ceiling Suspended 11 Sets | Wall Mounted 7 Sets | Concealed Duct 15 Sets | Console 3 Sets | Round Cassette 4 Sets

* This specification can be different as per each model or combination.

Compact : Maximize Space Utilization with Compact Size

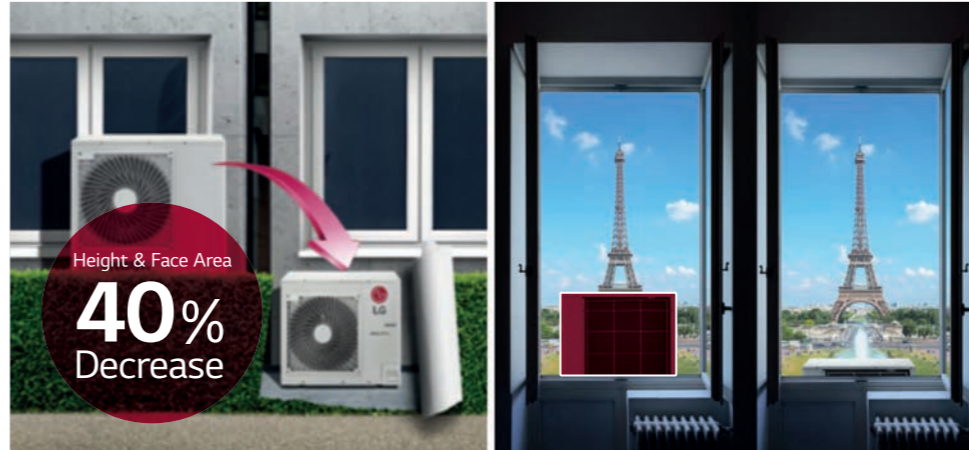

Height & Face Area
40% Decrease

Compact Size
Smaller Outdoor Unit

Energy Saving
SEER class : A+++ - A++

Flexible Installation
Max. pipe length up to 50m*

* This specification can be different as per each model or combination.

Free Combination

Enables to increase LG Single Split Line-up from 45 sets to 101 sets with only 5 outdoor units.

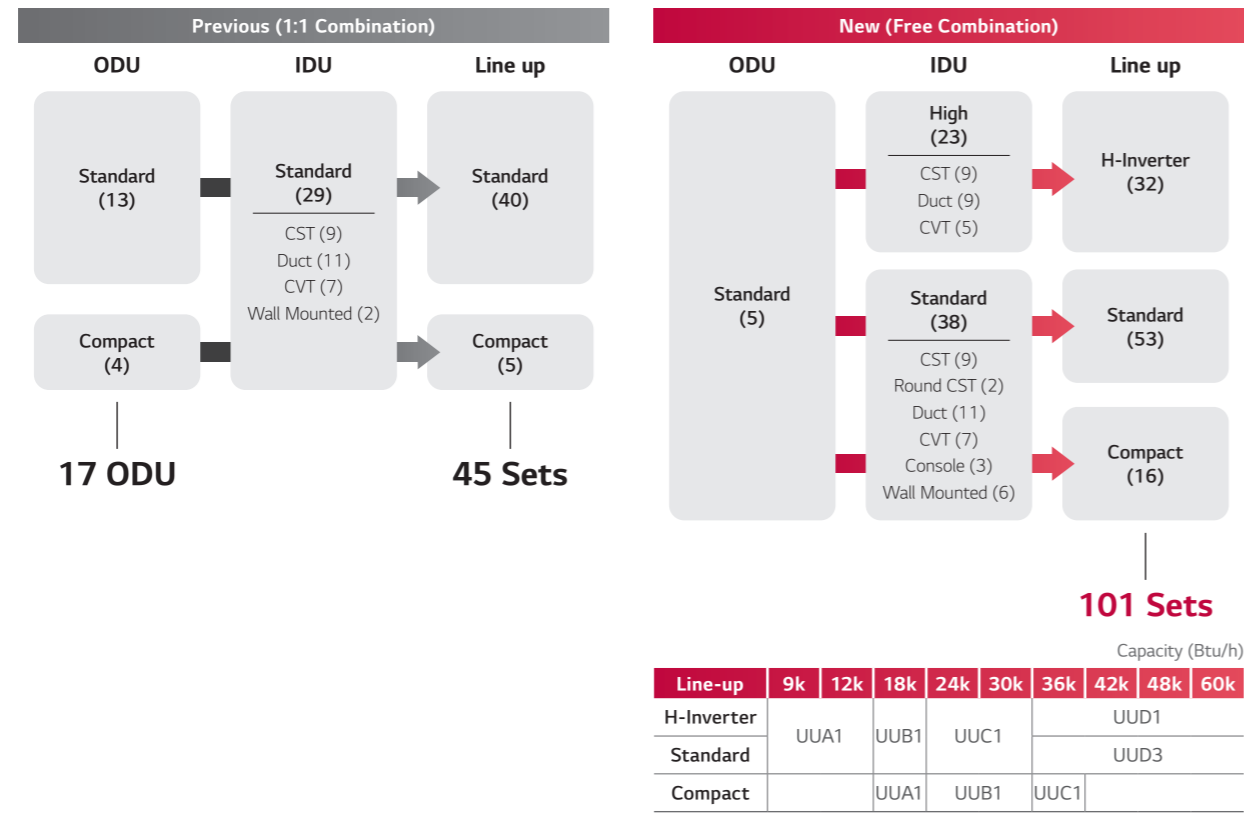

Differentiated Specification

LG Single split provide differentiated features (Performance / Installation / Convenience) by each product line.

Items	H-INVERTER	STANDARD	COMPACT	19Y Standard (R32)
	High Performance	Wide commercial applications	Compact & Cost Effective	
Performance	SEER Class	A+++ ~ A+	A++ ~ A+	A++ ~ A
	Cooling Capacity* @48°C	112%	105%	88%
	Heating Capacity* @-15°C	124%	107%	98%
	Operation Range* (Cooling, DB)	-20 ~ 50 °C		-10 ~ 48 °C
	Operation Range* (Heating, WB)	-20 ~ 18 °C		-15 ~ 18 °C
Installation	Max. Pipe Length*	50 m		35 m
	Cooling Capacity* @50m	113%	109%	-
	Drain Pump (Cassette)	●	●	●
	Drain Pump (Mid-static Duct)	●	Accessory	Accessory
Convenience	Humidity Control (Cassette, Suspended, Console)	●	●	●
	Wi-Fi (cassette)	Accessory	Accessory	Accessory
	Floor Detection (cassette)	Accessory	Accessory	Accessory
	Air purifying (cassette)	Accessory	Accessory	Accessory
	Human detection (cassette)	Accessory	Accessory	Accessory
Others	Synchro Application	N/A	36k ↑	N/A
	AHU Comm. Kit Application	18k ↑	18k ↑	24k ↑

※ Based on internal test data for 6.8kW model. (compared to 19Y standard model)
 ※ This specification can be different as per each model or combination.

Expanded Product Type

LG Single split expands from double to triple line-up including various types of indoor units.

		kW	2.5	3.4	5	6.8	8	9.5	12	13.4	14.6
		kBtu/h	9	12	18	24	30	36	42	48	60
Outdoor Units		●	UUA1	UUB1	UUC1				UUD1 UUD3		
		●		UUA1	UUB1	UUC1					
Ceiling Mounted Cassette		●	●	●	●	●	●	●	●	●	●
		●	●	●	●	●	●	●	●	●	●
		●									
Round Cassette		●						●		●	
Ceiling Concealed Duct	Mid Static	●			●	●	●	●	●	●	●
		●			●	●	●	●	●	●	●
	Low Static	●	●	●	●	●	●	●	●	●	●
		●			●	●	●	●	●	●	●
Ceiling Suspended		●			●	●	●	●	●	●	●
		●			●	●	●	●	●	●	●
Console		●	●	●							
Wall Mounted		●	●	●	●	●	●	●	●	●	●
		●						●	●		

● H-Inverter / ● Standard / ● Compact

Premium Solution for Retail Ceiling Cassette



Maximizing Business, Minimizing Cost

Premium Design & Customer Oriented Functions

- Premium interior with brighter (white) panel suit your shop
- Customer oriented functions with intelligent functions (Direct/Indirect Mode)
- Uniform space cooling & heating by power cooling & heating mode

Energy Savings

- Low operation cost by High SEER products
- Adjust evaporating temperature by dual sensing (Humidity + Temperature)
- Various energy saving solutions (scheduling, energy monitoring and interlocking)
- Real-time energy monitoring

Ease of Operation and Maintenance

- Convenient control via smartphone
- Intuitive wired remote controller

Customized Solution for Office Ceiling Cassette

Supporting Efficiency with Fresh and Comfort Air

Comfortable Office Environment

- Human oriented air flow (Direct/Indirect/Refresh mode)
- Foot thermal comfort by floor temperature detection
- Powerful performance by power cooling & heating mode
- High ceiling operation such as lobbies and reception areas (Max. 5m)

Energy Savings

- Adjust evaporating temperature by dual sensing
- Low operation cost with High SEER products
- Auto on/off operation by human detection
- LG's smart central controller provides a variety of energy saving solutions (scheduling, interlocking, peak control and energy navigation)

Ease of Operation and Maintenance

- Convenient control via smartphone
- Easy maintenance by elevation grille
- Convenient diagnosis by black box function



Comfort Solution for Residential Ceiling Concealed Duct



Creating a Comfortable Home with Low Cost

Simple & low cost Installation for Entire House

- Cooling or heating for several rooms with one set of Ceiling Concealed Duct
- Easy control of air volume for each rooms by zone controller accessory
- Flexible installation by ESP* control

Energy Savings

- Low operation cost with High SEER product
- Various energy saving solutions (scheduling, energy monitoring and interlocking)

Ease of Operation

- Anytime, anywhere control via smartphone
- Intuitive wired remote controller

Optimized Solution for Technical Wall Mounted

Reliable and Efficient Technical Cooling

Reliability

- Continuous cooling operation at -20 ~ 52°C*
- Quick & Reliable operation with temperature & pressure control
- Round-the-clock cooling (24h, 365 days)
- Power cooling mode for peak time
- Duty operation via server room controller

Energy Savings

- Low operation cost by High SEER product
- Real-time energy monitoring

Ease of Operation and Maintenance

- Convenient control via remote controller or centralized control
- Immediate diagnosis via mobile LGMV
- Accurate diagnosis via black box function

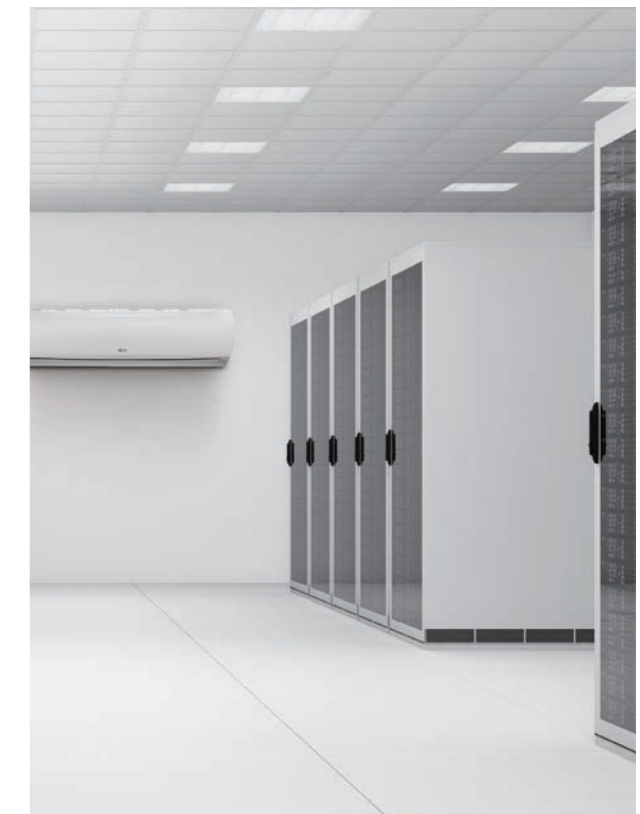

SEER / SCOP

LG's advanced technologies achieve world-class energy efficiency.



SEER / SCOP class

kW	2.5	3.4	5.0	6.8	8.0	9.5	Average
SEER	7.0	6.8	7.6	8.5	7.8	7.6	7.6
	A++	A++	A++	A+++	A++	A++	A++
SCOP	4.0	4.0	4.4	4.8	4.8	4.5	4.4
	A+	A+	A+	A++	A++	A+	A+

※ These values are based in the H-Inverter Ceiling Cassette model and can change based on the applied combination.

European Energy Labeling

	SEER	SCOP
A+++	SEER ≥ 8.5	SCOP ≥ 5.1
A++	6.1 ≤ SEER < 8.5	4.6 ≤ SCOP < 5.1
A+	5.6 ≤ SEER < 6.1	4.0 ≤ SCOP < 4.6
A	5.1 ≤ SEER < 5.6	3.4 ≤ SCOP < 4.0
B	4.6 ≤ SEER < 5.1	3.1 ≤ SCOP < 3.4
C	4.1 ≤ SEER < 4.6	2.8 ≤ SCOP < 3.1
D	3.6 ≤ SEER < 4.1	2.5 ≤ SCOP < 2.8

※ Based on Ceiling Cassette (6.8 kW)

Energy Savings

LG commercial air conditioners will automatically alter the temperature of discharge air by controlling their refrigerant temperature based on the difference between the indoor temperature and the target indoor temperature. During cooling operation, evaporating temperature will increase if the temperature difference reduces. This allows for enhanced comfort and reduced energy consumption.

Comfortable Indoor Air

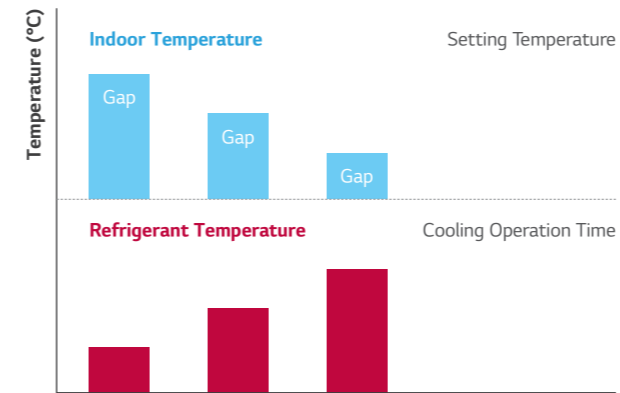

Energy Saving

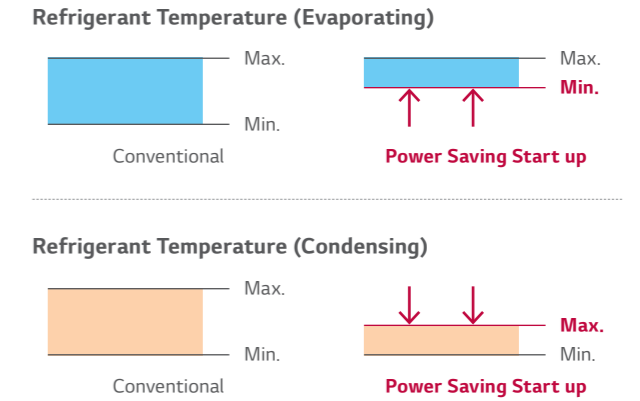

Peak Current Control

The peak current control function prevents the air conditioner from running at the maximum level while maintaining current system settings, in order to reduce energy consumption. This function helps minimize energy costs during the peak periods of energy use when the energy billing is much higher.

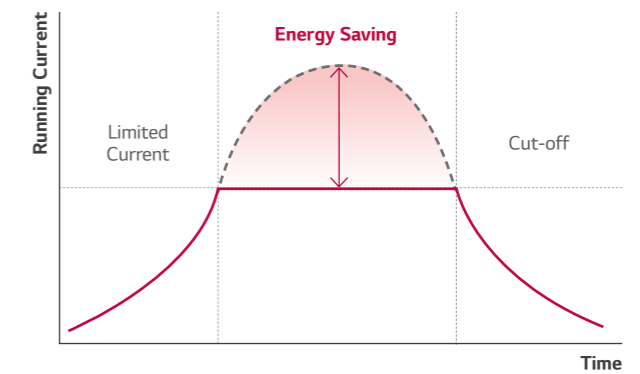

Mode Lock

Set the operation mode to either cooling-only or heating-only, either by adjusting the wired remote controller or setting the DIP switch to avoid combined use of cooling and heating. (Some models need wired remote controller for mode lock function according to feature overview table)

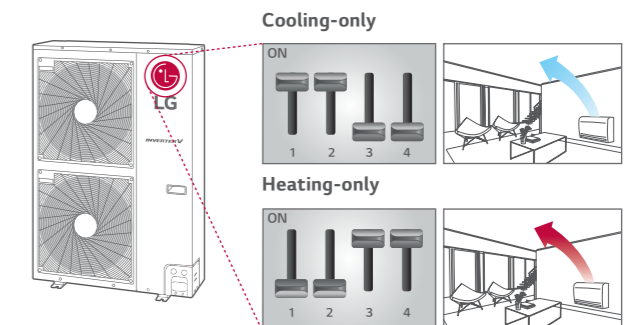

Comfort with Temperature & Humidity Sensors

With Dual Sensing Control, air conditioners can rapidly achieve a comfortable indoor environment for customers.



By sensing both temperature and humidity, this feature helps avoid over-cooling and dehumidification, maximizing comfort



※ Comfort cooling apply to Ceiling Cassette, Ceiling Suspended, Console
- It does not apply to small capacity cassette models. (UT09FH, UT12FH, CT09F, CT12F, CT18F)

Dry Summer

During a dry summer season, the system senses the low humidity levels and decreases the operating ratio to increase humidity for a more comfortable environment and energy efficient operation.

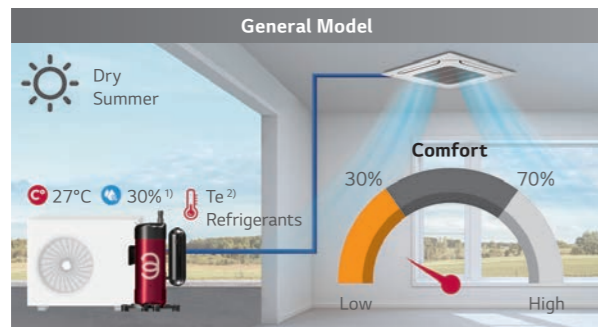

- **Uncomfortable Environment**
Excessive latent heat elimination regardless of humidity
- **Waste Energy**
Eliminate latent heat unnecessarily

※ Humidity Condition : Low (<30%), Standard (30-70%)
1) Indoor Condition 2) Evaporation Temperature

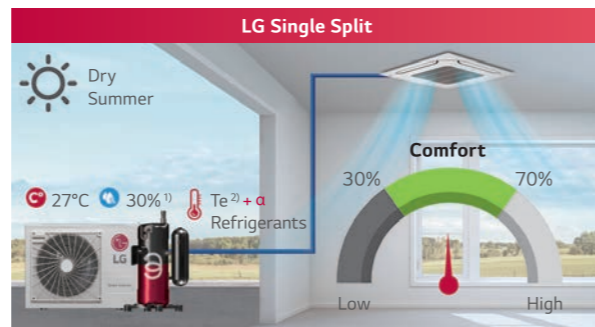

- **Comfortable Environment**
By making the room less dry
- **Increased Energy Efficiency**
Provide optimized cooling and save energy considering humidity

Wet Summer

During a wet summer season, the system senses the high humidity levels and increases the operating ratio to rapidly decrease humidity for a more comfortable indoor environment.

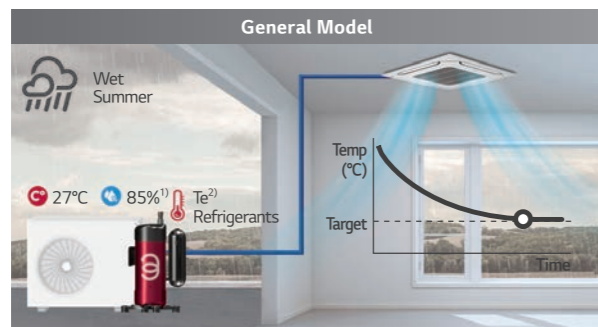

- **Uncomfortable Environment**
General latent heat elimination regardless of humidity

1) Indoor Condition 2) Evaporation Temperature

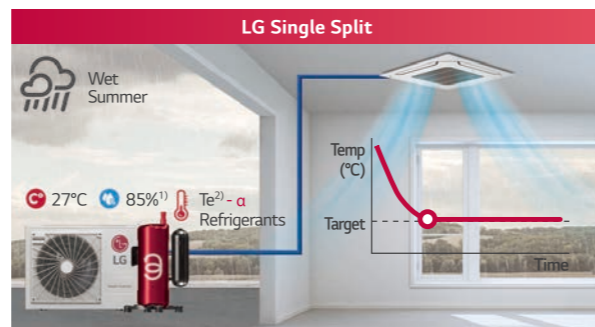

- **Comfortable Environment**
Quick latent heat elimination with humidity sensors

Night Silent Operation

Night Silent Operation can reduce noise levels at night time by simply setting the dip switch on the PCB of the outdoor unit.

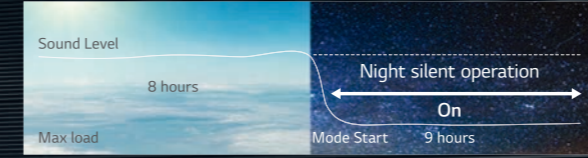

※ Refer to the install manual for details. (Setting method, operation time)

* The value is based on 14.6kW model.

Continuous Cooling Operation

LG Single Split is able to perform continuous cooling at low ambient temperature. (as low as -15°C)

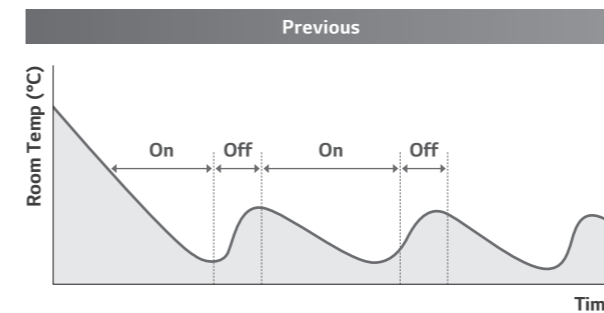

※ Outdoor -15°C

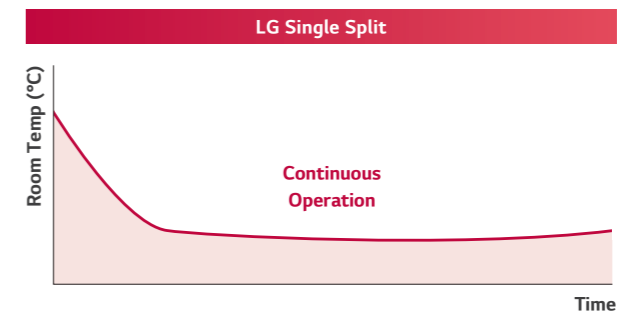

※ Outdoor -20°C



※ Based on a stand 36k model. (before 2019)



※ Based on a stand 36k model. (after 2019)

Quick & Reliable Operation

Through pressure and temperature sensing, the desired indoor temperature can be reached more rapidly.

- Quick response due to sensing with ready for operation.
- Target performance point is reached while avoiding compressor damage from liquid compression or oil shortage.

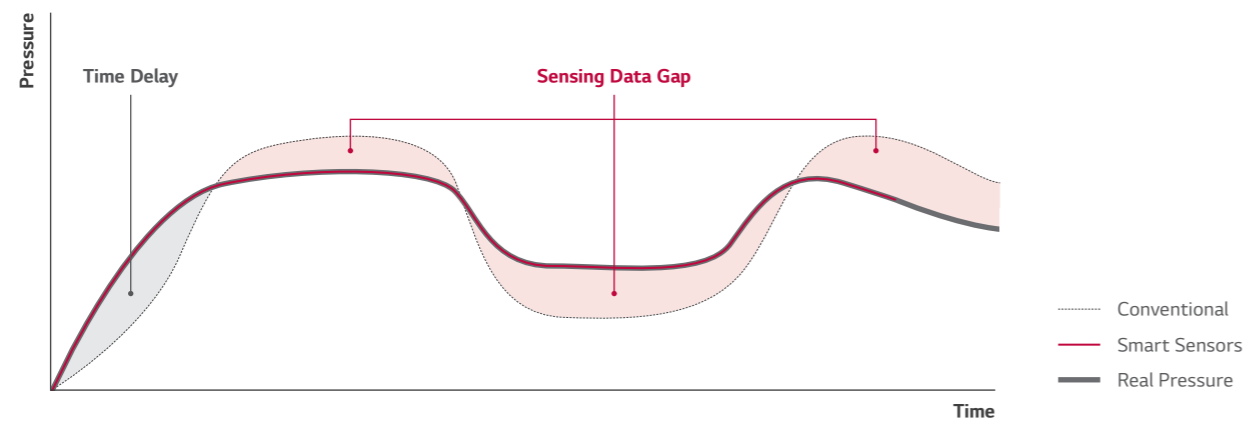
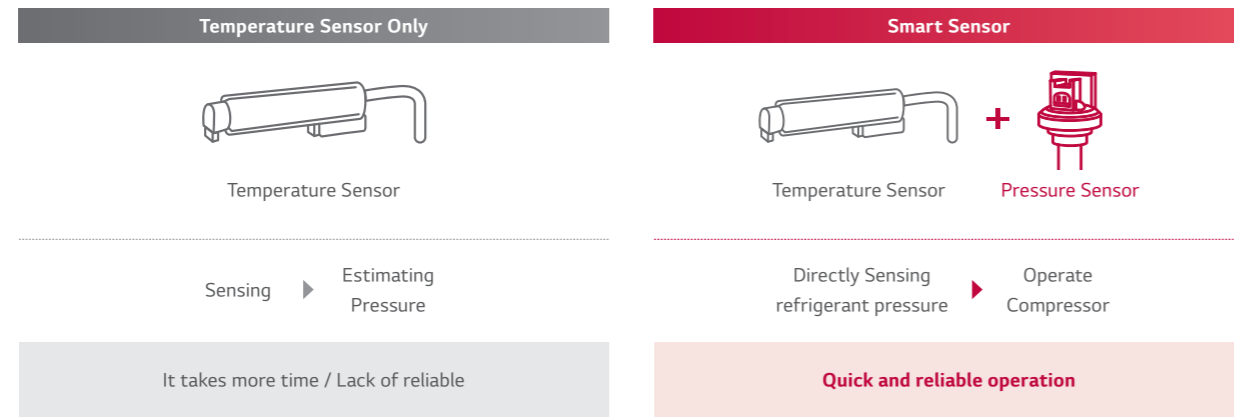

- With pressure sensing, the desired temperature is achieved in 30% less time in cooling and 44% in heating.

Cooling

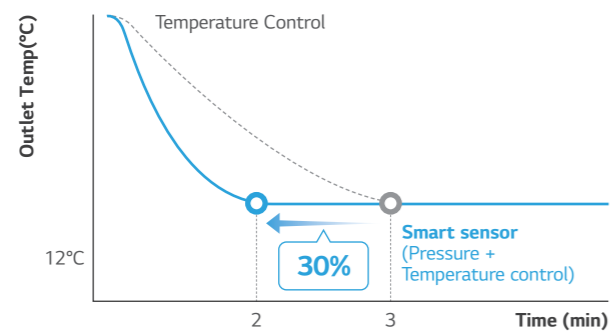

※ Based on internal test data.

Heating

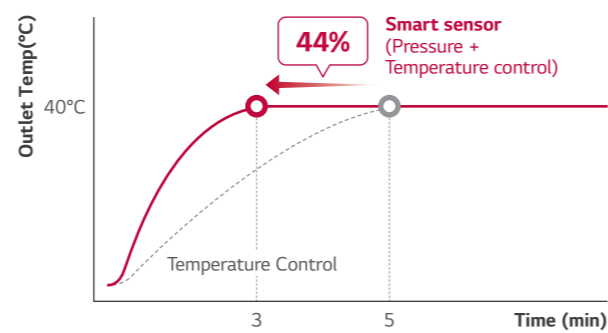

※ Based on internal test data.

R1 Compressor™

R1 Compressor is one that combines high-efficiency, low sound characteristics of the scroll and the simple compressing structure of the rotary compressor. This technology enables a highly efficient compact model.

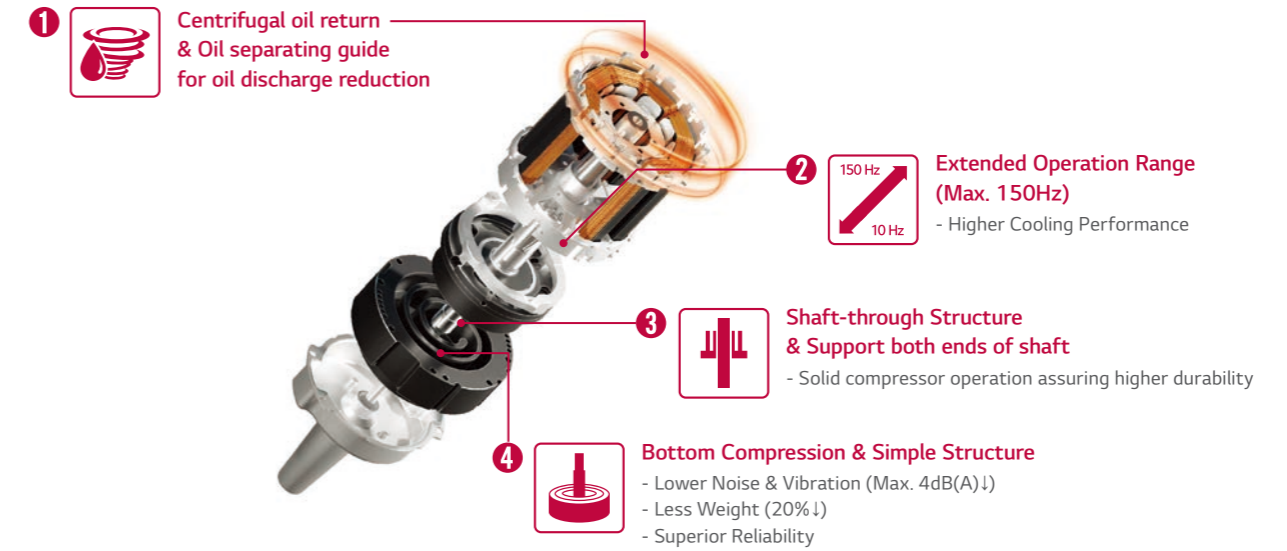

Conventional Compressor

Scroll
High efficiency / Low sound (Continuous compression, but complex structure)

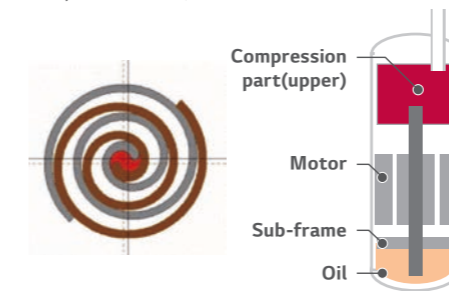

Rotary : Simple structure (Compression per 1 rotation)

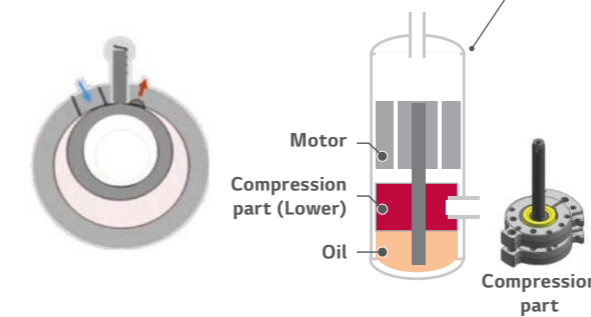

R1 Compressor™

Revolutionary Scroll
High efficiency / Stable & Simple Structure

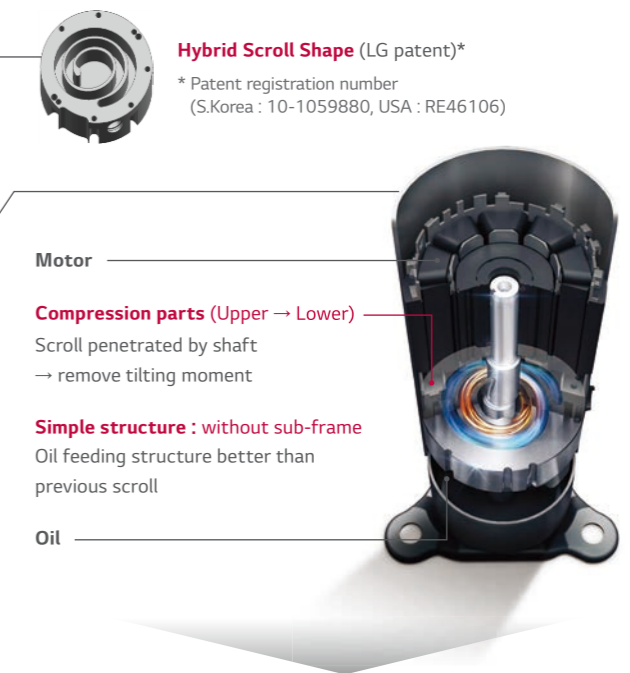

Extended operation (Max. 150Hz)
Low noise & Vibration (Max. 4dB(A)↓)
Less weight (20%↓)

Corrosion Resistance Black Fin

The black coating with enhanced epoxy resin is applied for strong protection from various corrosive external conditions such as salt contamination and air pollution including fumes from factories.

Longer Lifespan, Lower Maintenance Costs

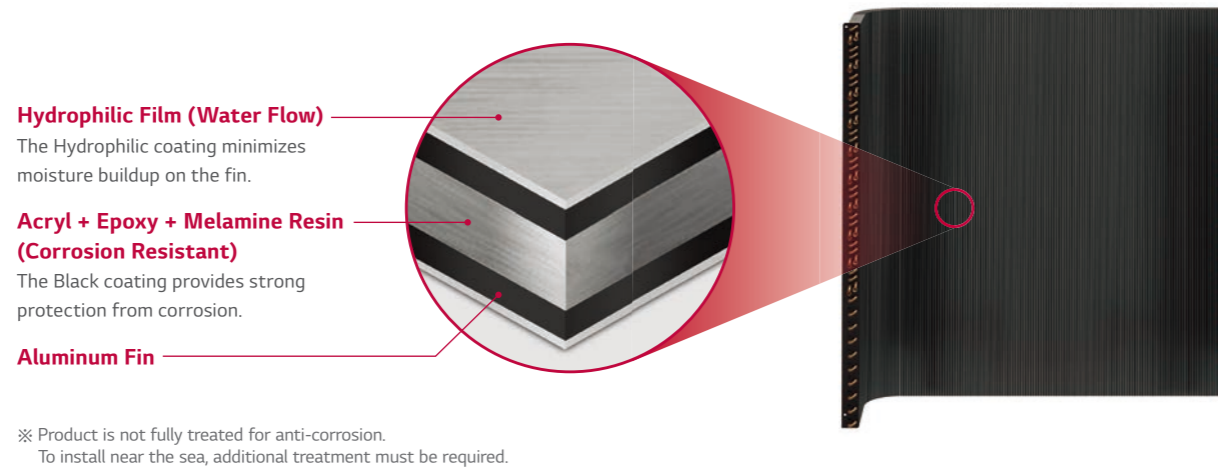

SST (Salt Spray Test)

Test Process



Test process is conducted according to ISO 9227.
1) Salty water concentration : NaCl aqueous solution (5%)

Test Result (5% Area of defects compared to initial)

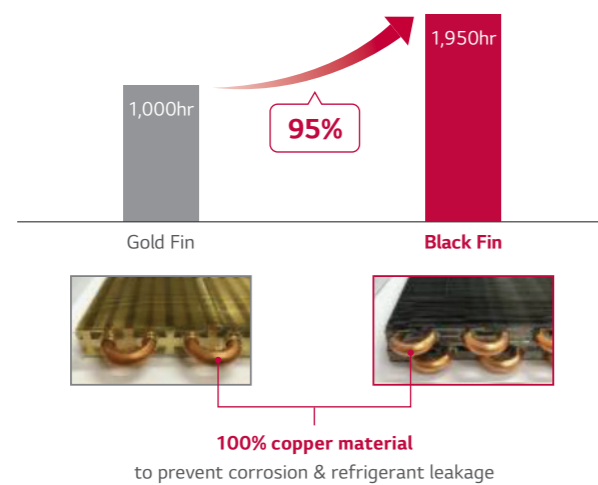

CCT (Cyclic Corrosion Test)

Test Process

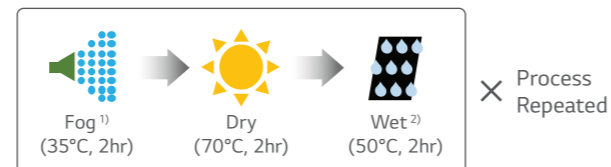

Test process is conducted according to ISO 14933.
1) Salty water concentration : NaCl aqueous solution (5%)
※ Dry condition changed : 60°C, 4hr → 70°C, 2hr
2) Deionized water

Test Result (5% Area of defects compared to initial)

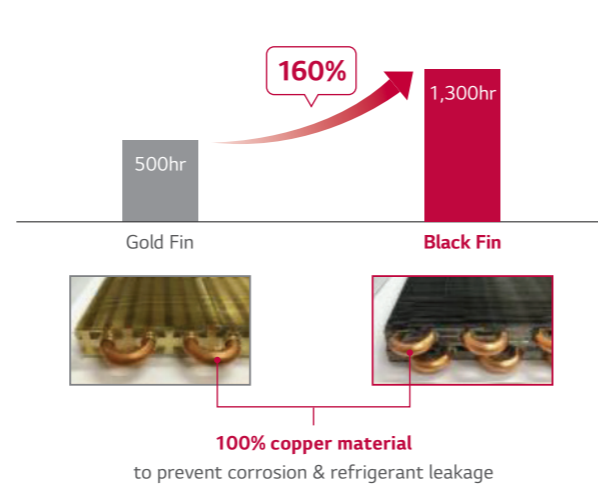

Long Pipe Installation

Maximum pipe length up to 85m and elevation length up to 30m provides flexibility for various conditions and easy installation.

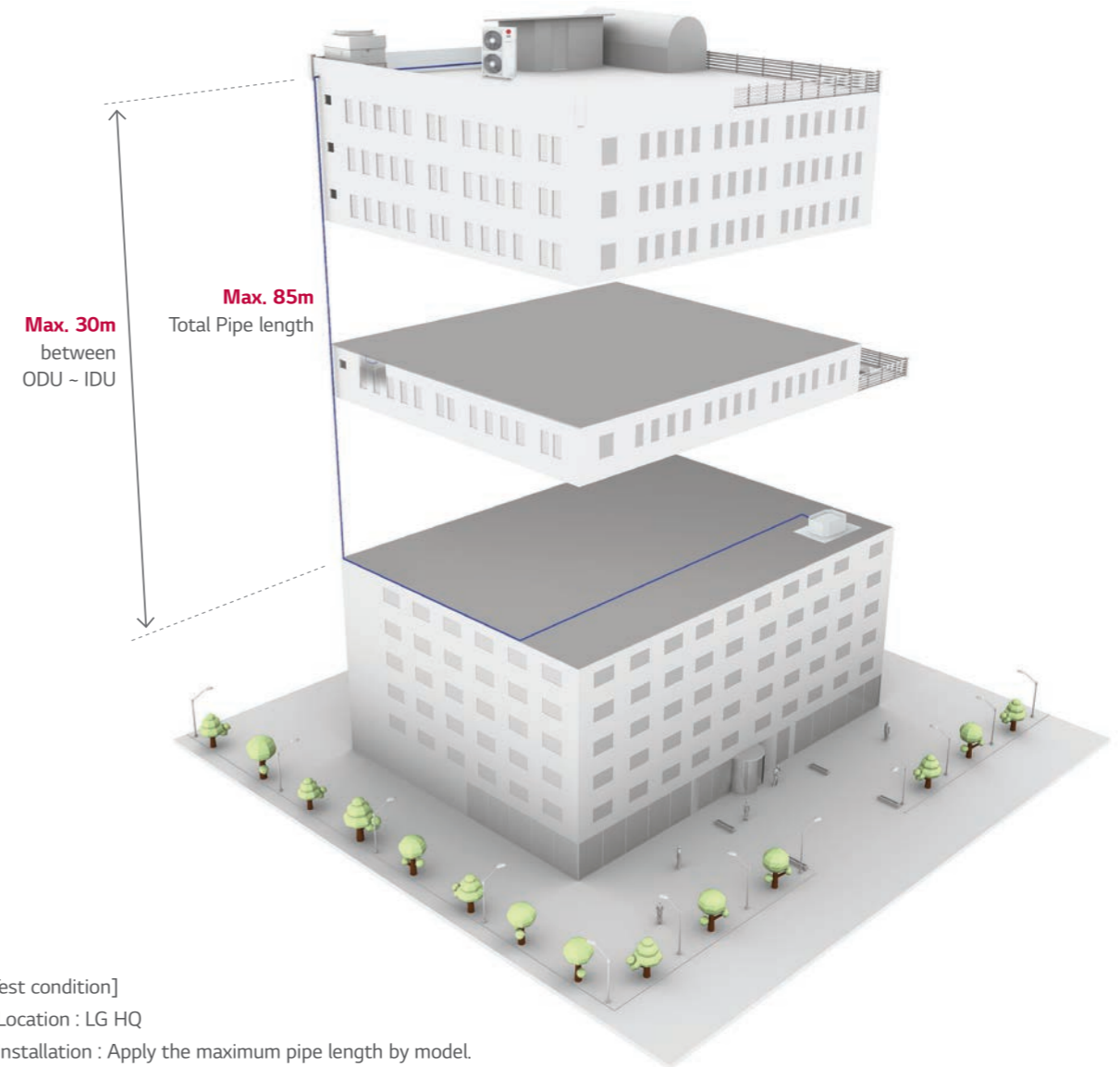

[Test condition]

- Location : LG HQ
- Installation : Apply the maximum pipe length by model.
- Period : 3 month (Checking oil level in real time)
- No use U-Trap

Model name	UUA1	UUB1	UUC1	UUD1 / UUD3
Maximum pipe length	20 m	30 / 35* m	50 m	85 m
Maximum Height Difference (ODU-IDU)	15 m	30 m	30 m	30 m

* Compact 6.8 / 8.0kW

Users can control air conditioners using Android or iOS-enabled smartphones and voice commands via Google assistant and Amazon's Alexa.

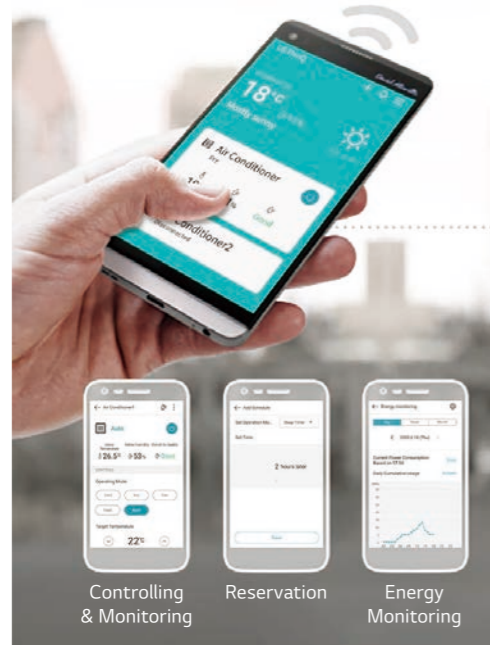

Access your air conditioner anytime and from anywhere



Simple operation for various functions

- Air Purify*
- On / Off*
- Mode Selection*
- Current temperature*
- Set temperature*
- Set fan speed*
- Vane Control

※ Search "LG ThinQ" on Google or Apple store then download the app.
 ※ Wi-Fi modem (PWFMD200) is required by option.

* This functions are used by google assistant
 ※ In some countries, the use of the google assistant system may be restricted.
 - Launched country : Germany, UK, Ireland, Austria, Switzerland, France, Spain, Italy, Russia, Norway, Netherlands, Portugal, Turkey, Sweden, Denmark

Easy Control (Central Controller)

PI-485 is a gateway device that provides communication between LG Outdoor Units and LG central controllers such as ACP, AC Smart.

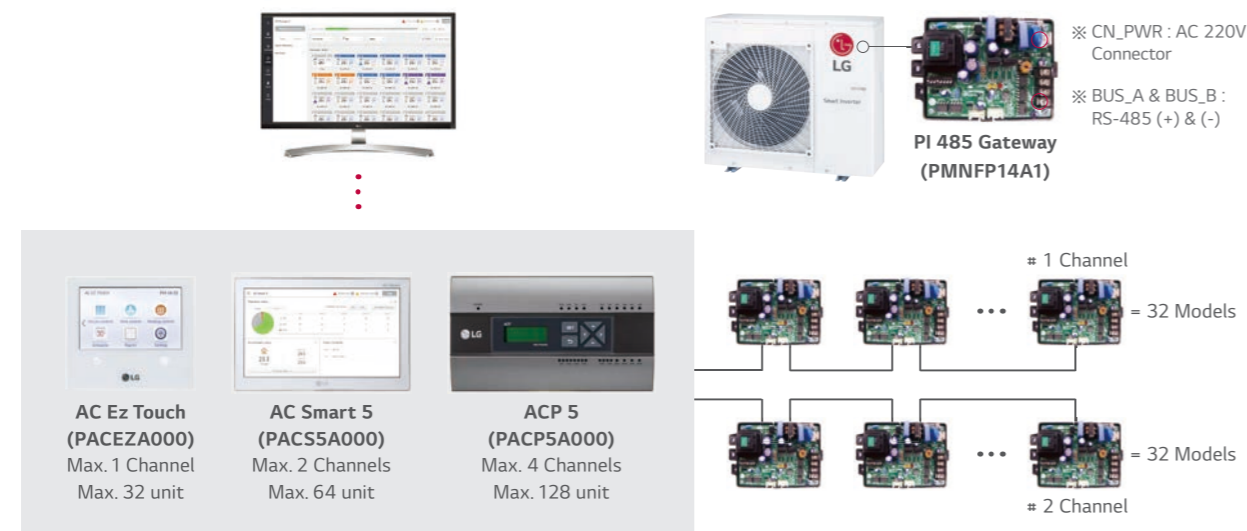

1 Point External Input (On / Off Control)

Indoor unit can be controlled by external devices without dry contact, so customers can save cost of installation.

Connection between an indoor unit and external devices directly



※ In case of needing more functions beside on / off control, a dry contact is required to be installed.

Forced Cooling Operation

This function allows the refrigerant to be recharged or pumped down, regardless of the indoor temperature. Note that this function can be used when indoor units are being moved or repaired.

Recharging

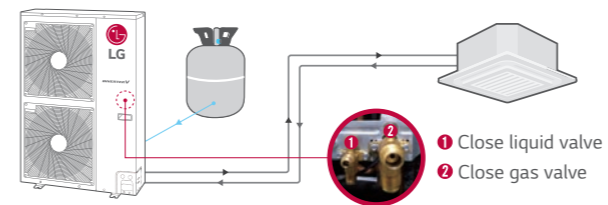

Pump Down

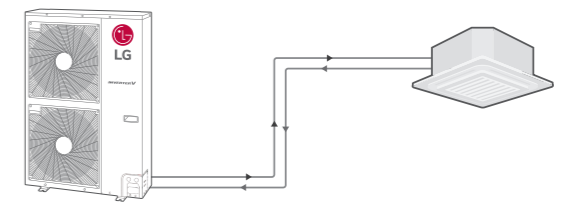

Mobile LGMV

LGMV(Monitoring View) helps engineers to inspect and monitor air conditioning unit easily.



Error Indicator

Contents	
01	Air temperature sensor of indoor unit
02	Inlet pipe temperature sensor of indoor unit
03	Communication error : Wired Remote Controller ↔ Indoor Unit

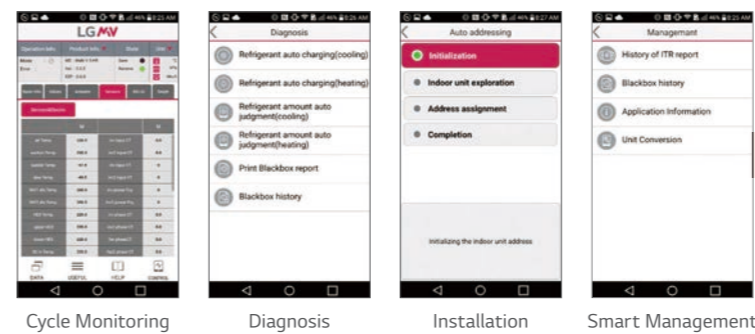

A technician not only can check the cycle information with diagrams & graph, but also check easily the error status (Troubleshooting guide) and take action immediately.

※ Search "Mobile LGMV" on Google or Apple store then download the app.
 ※ Wi-Fi modem (PWFMD200) is required by option.

Synchro function

Maximum 4 indoor units can be combined by using a branch kit and setting dip switch for one outdoor unit. It can be easily applied to various sites.

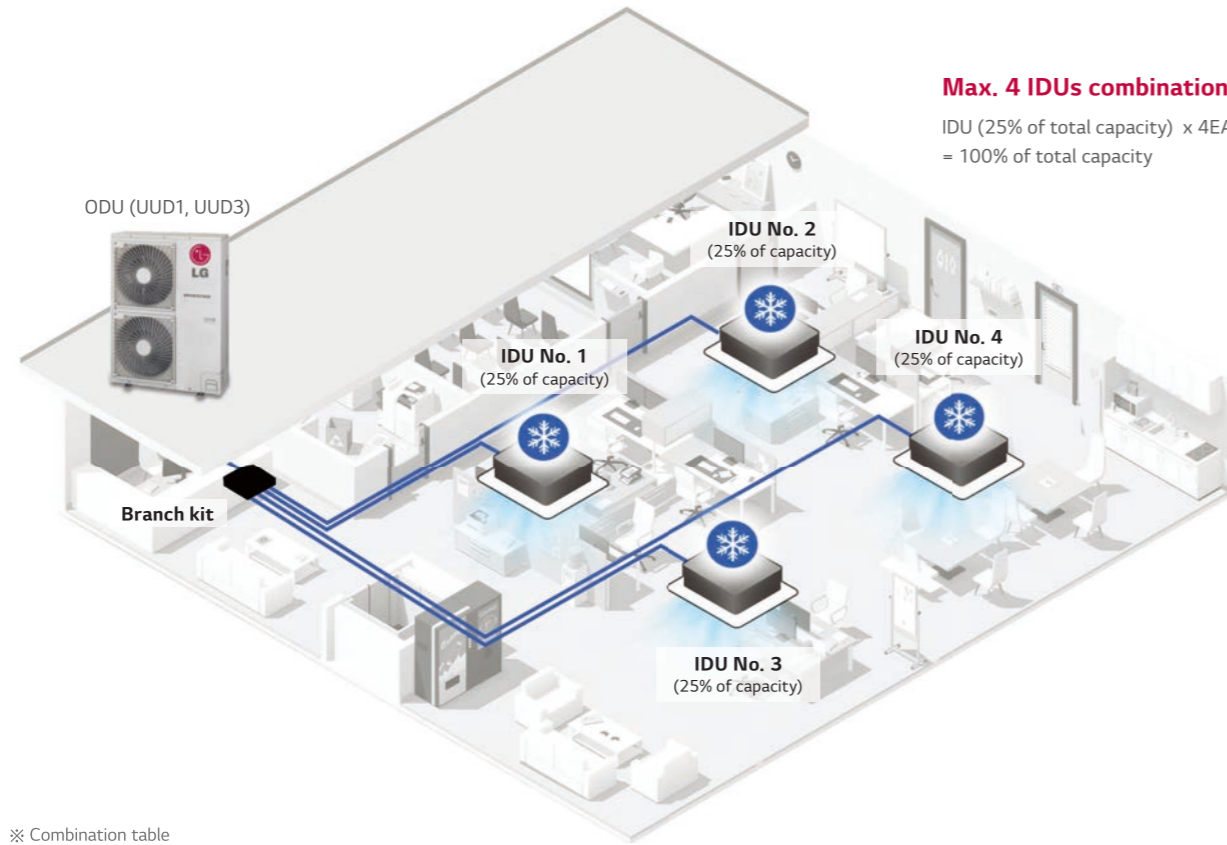

※ Combination table

	2 PMUB11A		3 PMUB111A		4 PMUB1111A	
Model	Duo		Trio		Quartet	
	Cassette	Duct	Cassette	Duct	Cassette	duct
UUD1, UUD3	CT18F x 2EA	CM18F x 2EA	CT12F x 3EA	CL12F x 3EA	CT12F x 4EA	CL12F x 4EA
	CT24F x 2EA	CM24F x 2EA	CT18F x 3EA	CM18F x 3EA	-	-
	UT30F x 2EA	UM30F x 2EA	-	-	-	-
Branch kit	PMUB11A		PMUB111A		PMUB1111A	
Dip switch						

Note

- Possible indoor units : Single CAC indoor unit series
 - Dry contact & Zone control & Auto changeover is not available which is connected with synchro.
 - When using synchro operation
 - Do not use wireless remote controller.
 - Use only one wired remote controller in the indoor units.
 - Some Central controllers and some functions of central controller can not be available with synchro operation.
- Branch kits are required for operating Synchro models.

Connection with AHU

Single split can be connected to AHU using communication kit.

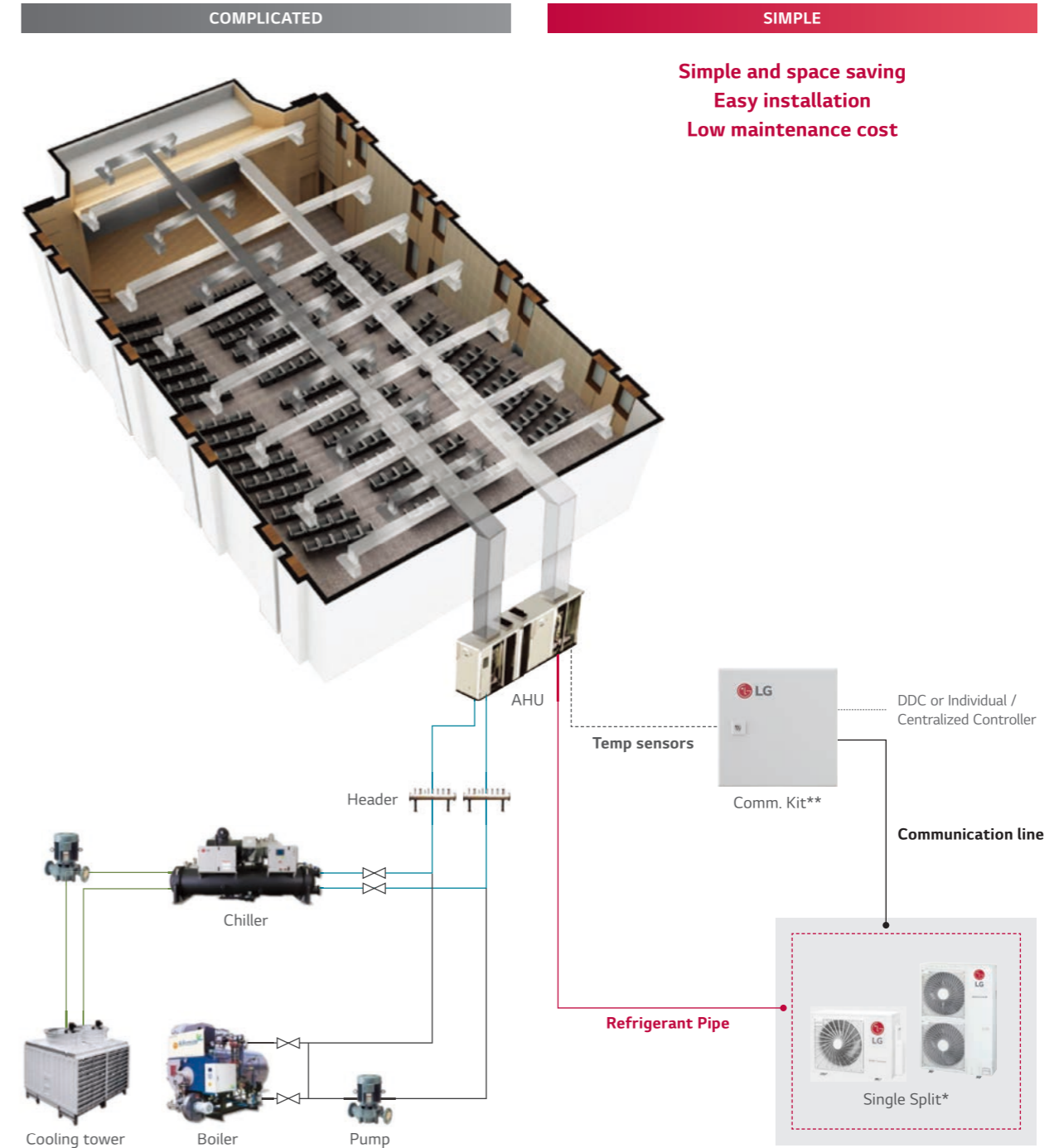

Complicated piping work

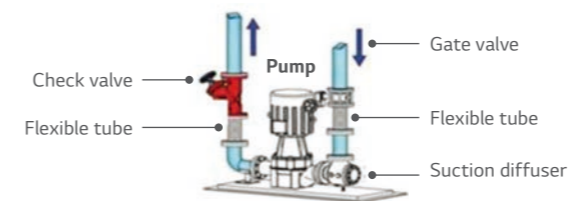

* The single model can be applied only to UUB1, UUC1, UUD1, UUD3
 ** Model name of communication kit
 - RA air temperature control : PAHCMR000
 - SA air temperature control : PAHCMS000

CEILING MOUNTED CASSETTE



4 Way air flow with new dual vane design

Innovative dual vane designs each of the best airflow over various spaces.



NEW DESIGN

COMMERCIAL SINGLE SPLIT

New types of wind solutions

Indirect Wind



Direct Wind



6 Air flow modes

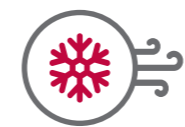

Power Mode
Fast and Quick



Up / Down Swing
Fresh and Natural



Smart Mode
Auto Vane Control

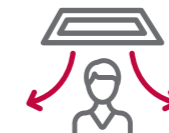

Indirect Wind
Indirect cooling & Heating



Direct Wind
Suitable for High Ceiling



Refresh Mode
Provide high concentration

Brighter Color

Color enhancement allows cassette to blend in to most interior ceiling spaces.

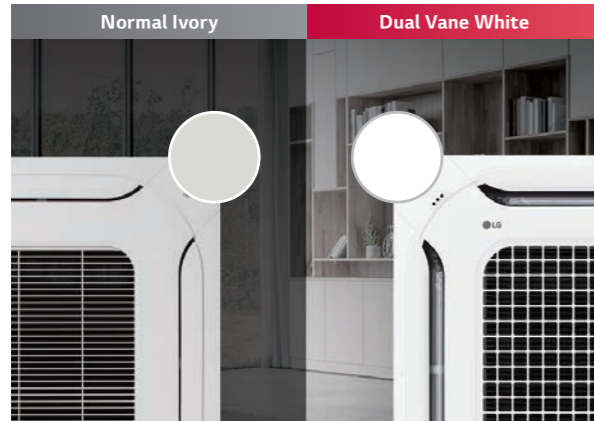

Wide Design

Bigger inlet and outlet make faster cooling / heating airflow.

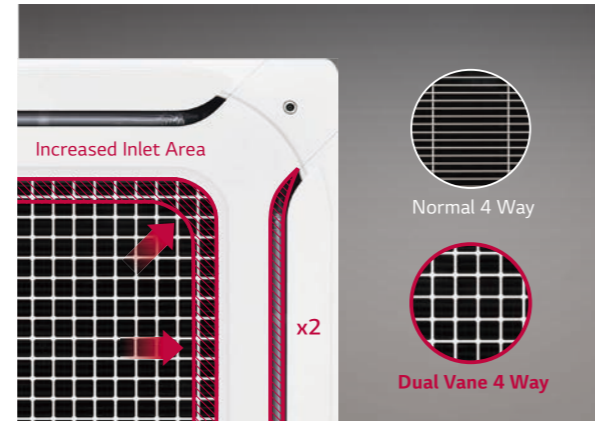

Full 3D Turbo Fan

Full 3D Turbo fan decreases air resistance, so it creates high efficiency and reduces noise level.



High Efficiency Heat Exchanger (HEX)

Highly integrated heat exchanger is applied to increase cooling and heating efficiency.

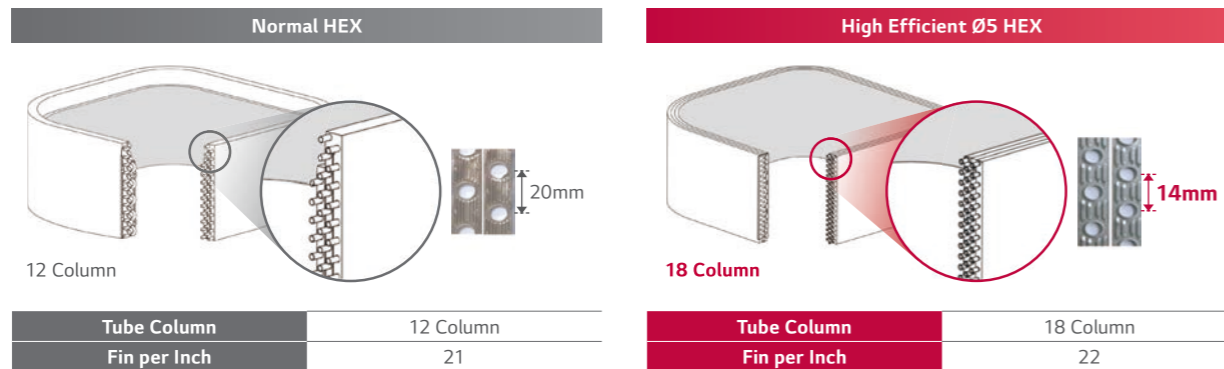

※ This specification can be different as per each model.

Sensor reads temperature from ceiling to floor for heating

IDU provides the human oriented room temperature with sensing floor And calculating by floor and ceiling temperature by thermopile sensor.

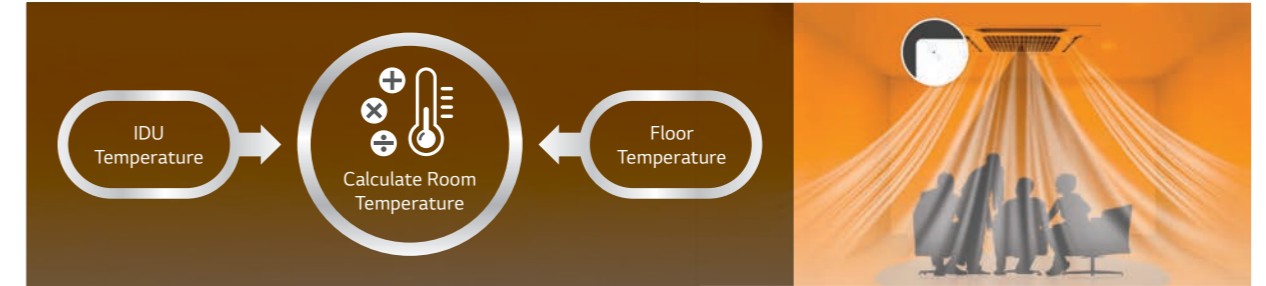

※ Available only for products with floor temperature sensor.

Human detecting Direct / Indirect airflow

Human sensing function finds users to provide their favorite airflow.

Comfort Indirect

Prevent airflow to heading to user by sensing.



Follow user Direct

Prefer air flow to heading to user by sensing.



Direct Wind

Warm wind can reach up to 5m with plenty air volume. (@ 0.5ms)



Dual Vane 4Way Cassette must set a Super High Ceiling Mode.

* Settings are required in installer mode.

Human detecting On / Off Learning operation system

IDU senses people to switch On / Off for Max. 54% power saving.

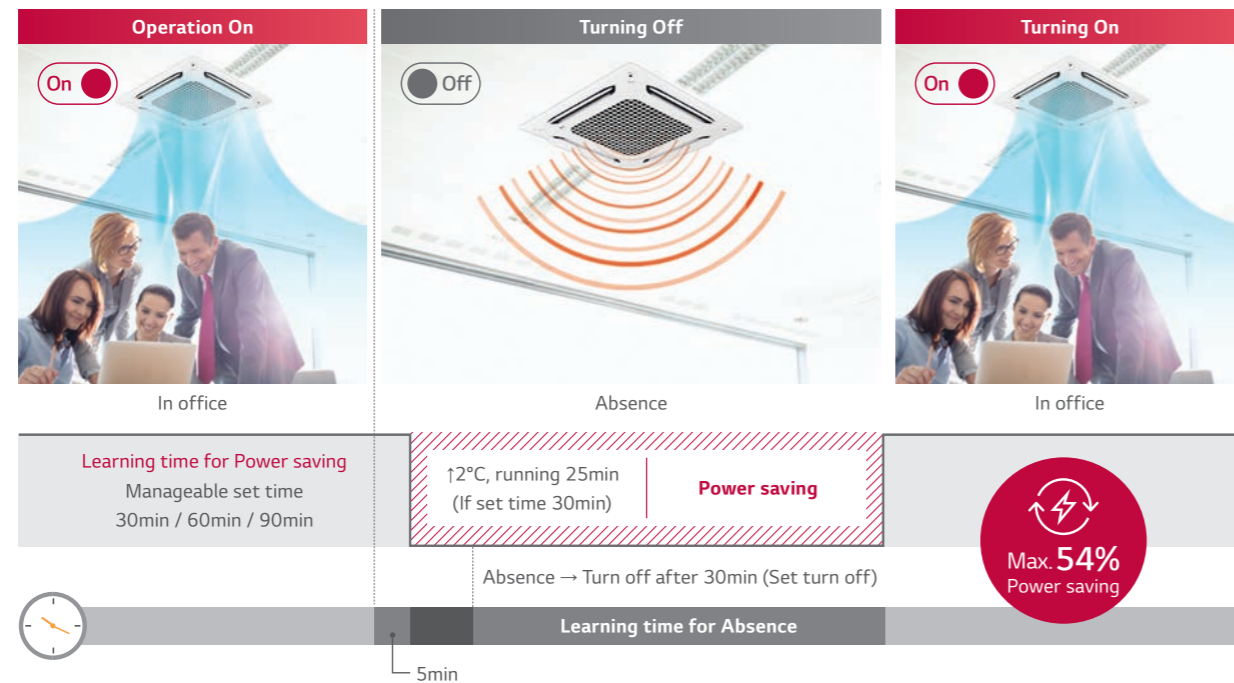

※ Smart Dual Vane Indoor Unit '19 Line up.
 ※ Data Based on actual test of LG, single product 2 hours measurement result. (Cooling 26 °C, strong wind)

Various Display of Air Purification

Installed Wi-Fi leads unlimited boundary to control IDU and display Air Purification status.

Smart indicator

Shows quality of Indoor air in real time

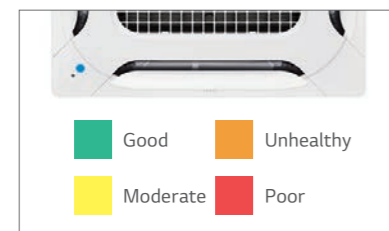

Remote controller

Display Air status and Fine Dust Concentration



Mobile

Whenever & Wherever Check and Control Air status



Pairing LG ThinQ

Anywhere! Anytime! Can connect to IDU with LG ThinQ

- Monitoring Air status : Easy to check indoor air status
 - Microfine dust / Ultra fine dust / Fine dust
 - Day / Week / Month / Yearly
- Mobile Remote Control : Remote control by using mobile phone
 - Control Mode / Temperature / Air flow etc.
- Display Power Consumption : Check power consumption of A/C
 - Check energy display
 - Set target energy consumption level



Convenient and Powerful Air purification

Easy to manage air purifying system with one-touch air cleaning filter.

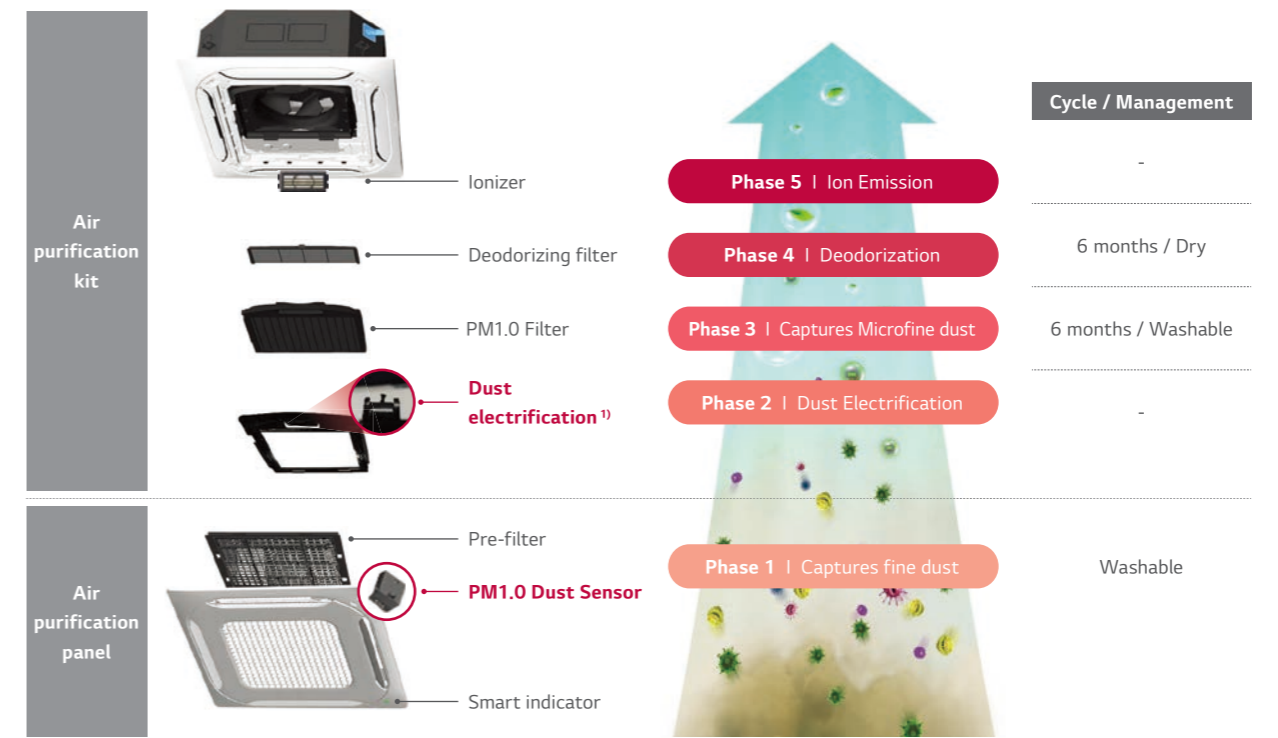

1) Electrical diffusion makes dust electrification.

CAC certification?

The Korea Air Cleaning Association strictly tests the air cleaning function of air conditioner products and provide certification to the product that give credibility to consumers.



Air Purification Technology

5-Steps air cleaning process removes invisible, ultra fine dust, odor and germs to ensure a clean and healthy living environment

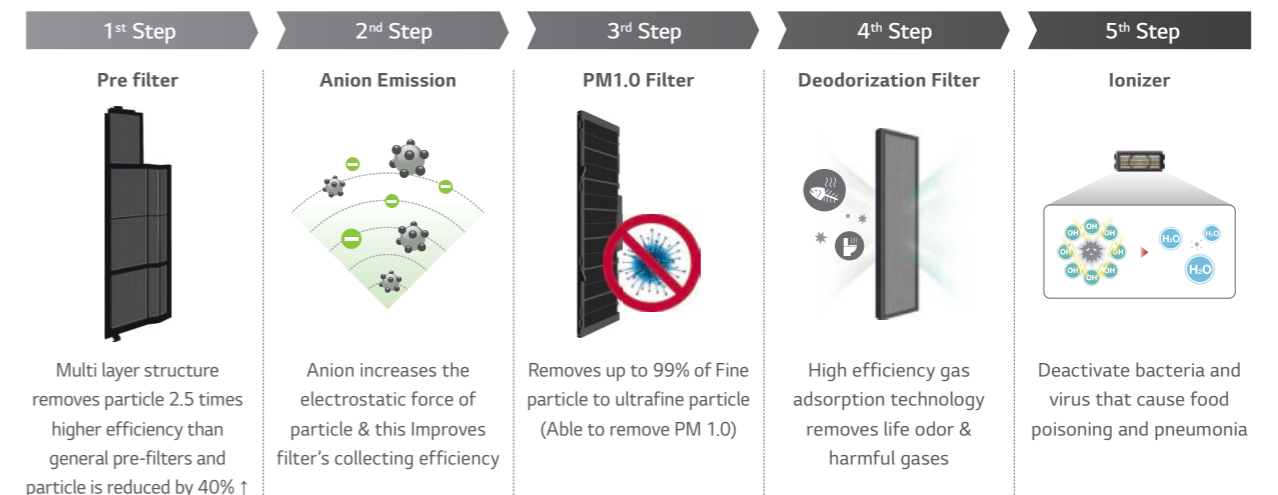

H-INVERTER (R32)

UT09FH / UT12FH / UT18FH



LG participates in the ECP programme for EUROVENT AC program. Check ongoing validity of certification : www.eurovent-certification.com

UUA1 ULO UUB1 U20



COMBINATION				9	12	18
Capacity	Cooling	Min. / Rated / Max.	kW	1.6 / 2.5 / 4.0	1.6 / 3.4 / 4.8	2.0 / 5.0 / 6.0
	Heating	Min. / Rated / Max.	kW	1.7 / 3.2 / 4.5	1.7 / 4.1 / 5.8	2.3 / 5.8 / 7.0
Power Input (Set)	Cooling	Min. / Rated / Max.	kW	0.32 / 0.61 / 0.98	0.32 / 0.97 / 1.78	0.30 / 1.25 / 1.69
	Heating	Min. / Rated / Max.	kW	0.32 / 0.75 / 1.06	0.32 / 1.03 / 1.87	0.30 / 1.47 / 1.98
Running Current	Cooling	Rated	A	2.7	4.3	7.2
	Heating	Rated	A	3.3	4.6	7.7
EER / COP			kWh/kWh	4.10 / 4.30	3.50 / 4.00	4.00 / 3.95
SEER / SCOP			kWh/kWh	7.0 / 4.0	6.8 / 4.0	7.6 / 4.4
Pdesign	Cooling @ 35°C		kW	2.5	3.4	5.0
	Heating @ -10°C		kW	2.8	2.8	4.1
Seasonal Energy Label	Cooling / Heating		-	A++ / A+	A++ / A+	A++ / A+
Annual Energy Consumption	Cooling / Heating		kWh	125 / 980	175 / 980	230 / 1,305
Dehumidification Rate			l/h	0.1	0.8	1.9
ODU Sound Pressure Level	Cooling / Heating	Rated	dB(A)	49 / 52	49 / 52	47 / 52
ODU Sound Power Level	Cooling	Rated	dB(A)	65	65	63
Piping Connections	Liquid		mm (inch)	Ø6.35 (1/4)	Ø6.35 (1/4)	Ø6.35 (1/4)
	Gas		mm (inch)	Ø9.52 (3/8)	Ø9.52 (3/8)	Ø12.7 (1/2)
	Connections Method		-	Flared	Flared	Flared
Operation Range (Outdoor)	Cooling	Min. / Max.	°C	-15 / 50	-15 / 50	-15 / 50
	Heating	Min. / Max.	°C	-20 / 18	-20 / 18	-20 / 18
INDOOR				UT09FH NQ0	UT12FH NQ0	UT18FH NQ0
Power Supply			Ø / V / Hz	1 / 220-240 / 50	1 / 220-240 / 50	1 / 220-240 / 50
Power Input (IDU)		H / M / L	W	30 / 26 / 22	30 / 26 / 22	33 / 26 / 22
Air Flow Rate		H / M / L	m³/min	11.0 / 10.0 / 9.3	11.0 / 10.0 / 9.3	17.0 / 15.5 / 14.0
Dimensions	Body	W x H x D	mm	570 x 256 x 570	570 x 256 x 570	840 x 204 x 840
	Weight		kg	13.9	13.9	21.1
Sound Pressure Level	Cooling	H / M / L	dB(A)	41 / 39 / 37	41 / 39 / 37	37 / 36 / 34
Sound Power Level	Cooling	Max.	dB(A)	54	54	52
Piping Connections	Drain	O.D. / I.D.	mm	Ø32.0 / 25.0	Ø32.0 / 25.0	Ø32.0 / 25.0
Recommended Decoration Panel*	Model Name		-	PT-QAGW0	PT-QAGW0	PT-AFGW0
	Color		-	White	White	White
	Dimensions	Body	mm	620 x 34 x 620	620 x 34 x 620	950 x 35 x 950
	Weight	Body	kg	3.0	3.0	7.5
OUTDOOR				UUA1 ULO	UUB1 U20	
Power Supply			Ø / V / Hz	1 / 220-240 / 50	1 / 220-240 / 50	
Circuit Breaker		Min.	A	15	20	
Power Supply Cable (Included Earth)			No x mm³	3C x 1.5	3C x 2.5	
Dimensions	Net	W x H x D	mm	770 x 545 x 288	870 x 650 x 330	
	Weight	Net	kg	33.3	44.5	
Compressor	Type		-	Twin Rotary	Twin Rotary	
	Type		-	R32	R32	
	GWP (Global Warming Potential)		-	675	675	
	Precharged Amount		kg	1.0	1.2	
Refrigerant	t-CO ₂ eq		-	0.675	0.81	
	Additional Charge (After 7.5m)		g/m	20	20	
	Fan	Air Flow Rate	Rated	m³/min x No.	28 x 1	50 x 1
Total Piping Length		Min. / Max.	m	5 / 30	5 / 30	
Piping Elevation	IDU - ODU	Max	m	30	30	

* Decoration panel can be selected as an optional accessory. Note :

- Due to our policy of innovation some specifications may be changed without notification.
- Performances are based on the following conditions (It is accordance with EN14511)
 - Cooling : Indoor Ambient Temp 27°C DB / 19°C WB, Outdoor Ambient Temp 35°C DB / 24°C WB
 - Heating : Indoor Ambient Temp 20°C DB / 15°C WB, Outdoor Ambient Temp 7°C DB / 6°C WB
 - Interconnected Pipe is standard length and difference of Elevation (Outdoor - Indoor Unit) is 0m.
- Sound Level Values are measured at Noise Measuring chamber accordance with standard. Therefore, these values depend on the ambient conditions and values are normally higher in actual operation.
- This product contains fluorinated greenhouse gases. (R32)

H-INVERTER (R32)

UT24FH / UT30FH



LG participates in the ECP programme for EUROVENT AC program. Check ongoing validity of certification : www.eurovent-certification.com

UUC1 U40



COMBINATION				24	30
Capacity	Cooling	Min. / Rated / Max.	kW	2.7 / 6.8 / 8.3	3.2 / 8.0 / 9.5
	Heating	Min. / Rated / Max.	kW	3.2 / 7.9 / 9.9	3.6 / 9.0 / 10.7
Power Input (Set)	Cooling	Min. / Rated / Max.	kW	0.30 / 1.66 / 2.31	0.40 / 2.12 / 2.82
	Heating	Min. / Rated / Max.	kW	0.40 / 1.76 / 2.53	0.40 / 2.14 / 2.93
Running Current	Cooling	Rated	A	7.4	9.4
	Heating	Rated	A	7.8	9.5
EER / COP			kWh/kWh	4.10 / 4.48	3.77 / 4.20
SEER / SCOP			kWh/kWh	8.5 / 4.8	7.8 / 4.8
Pdesign	Cooling @ 35°C		kW	6.8	8
	Heating @ -10°C		kW	5.5	5.5
Seasonal Energy Label	Cooling / Heating		-	A+++ / A++	A++ / A++
Annual Energy Consumption	Cooling / Heating		kWh	280 / 1,604	359 / 1,604
Dehumidification Rate			l/h	1.7	2.7
ODU Sound Pressure Level	Cooling / Heating	Rated	dB(A)	48 / 52	50 / 52
ODU Sound Power Level	Cooling	Rated	dB(A)	65	68
Piping Connections	Liquid		mm (inch)	Ø9.52 (3/8)	Ø9.52 (3/8)
	Gas		mm (inch)	Ø15.88 (5/8)	Ø15.88 (5/8)
	Connections Method		-	Flared	Flared
Operation Range (Outdoor)	Cooling	Min. / Max.	°C	-20 / 50	-20 / 50
	Heating	Min. / Max.	°C	-20 / 18	-20 / 18
INDOOR				UT24FH NAO	UT30FH NAO
Power Supply			Ø / V / Hz	1 / 220-240 / 50	1 / 220-240 / 50
Power Input (IDU)		H / M / L	W	43 / 35 / 28	43 / 35 / 28
Air Flow Rate		H / M / L	m³/min	23.8 / 21.4 / 19.0	23.8 / 21.4 / 19.0
Dimensions	Body	W x H x D	mm	840 x 288 x 840	840 x 288 x 840
	Weight		kg	25.3	25.3
Sound Pressure Level	Cooling	H / M / L	dB(A)	42 / 41 / 40	42 / 41 / 40
Sound Power Level	Cooling	Max.	dB(A)	56	56
Piping Connections	Drain	O.D. / I.D.	mm	Ø32.0 / 25.0	Ø32.0 / 25.0
Recommended Decoration Panel*	Model Name		-	PT-AFGW0	PT-AFGW0
	Color		-	White	White
	Dimensions	Body	mm	950 x 35 x 950	950 x 35 x 950
	Weight	Body	kg	7.5	7.5
OUTDOOR				UUC1 U40	
Power Supply			Ø / V / Hz	1 / 220-240 / 50	
Circuit Breaker		Min.	A	25	
Power Supply Cable (Included Earth)			No x mm³	3C x 2.5	
Dimensions	Net	W x H x D	mm	950 x 834 x 330	
	Weight	Net	kg	57.7	
Compressor	Type		-	Twin Rotary	
	Type		-	R32	
	GWP (Global Warming Potential)		-	675	
	Precharged Amount		kg	1.9	
Refrigerant	t-CO ₂ eq		-	1.283	
	Additional Charge (After 7.5m)		g/m	40	
	Fan	Air Flow Rate	Rated	m³/min x No.	58 x 1
Total Piping Length		Min. / Max.	m	5 / 50	
Piping Elevation	IDU - ODU	Max.	m	30	

* Decoration panel can be selected as an optional accessory. Note :

- Due to our policy of innovation some specifications may be changed without notification.
- Performances are based on the following conditions (It is accordance with EN14511)
 - Cooling : Indoor Ambient Temp 27°C DB / 19°C WB, Outdoor Ambient Temp 35°C DB / 24°C WB
 - Heating : Indoor Ambient Temp 20°C DB / 15°C WB, Outdoor Ambient Temp 7°C DB / 6°C WB
 - Interconnected Pipe is standard length and difference of Elevation (Outdoor - Indoor Unit) is 0m.
- Sound Level Values are measured at Noise Measuring chamber accordance with standard. Therefore, these values depend on the ambient conditions and values are normally higher in actual operation.
- This product contains fluorinated greenhouse gases. (R32)

H-INVERTER (R32)

UT36FH / UT42FH / UT48FH / UT60FH



LG participates in the ECP programme for EUROVENT AC program. Check ongoing validity of certification : www.eurovent-certification.com

UUD1 U30



COMBINATION				36	42	48	60
Capacity	Cooling	Min. / Rated / Max.	kW	38 / 9.5 / 12.8	48 / 12.1 / 14.5	5.4 / 13.4 / 16.1	6.0 / 15.0 / 16.2
	Heating	Min. / Rated / Max.	kW	4.3 / 10.8 / 13.7	5.4 / 13.5 / 16.2	6.2 / 15.5 / 17.8	7.0 / 17.5 / 19.3
Power Input (Set)	Cooling	Min. / Rated / Max.	kW	0.40 / 2.15 / 3.23	0.60 / 3.14 / 4.24	0.80 / 3.83 / 5.17	0.90 / 4.69 / 5.25
	Heating	Min. / Rated / Max.	kW	0.50 / 2.40 / 3.36	0.70 / 3.29 / 4.28	0.80 / 4.18 / 5.24	1.10 / 5.38 / 6.19
Running Current	Cooling	Rated	A	9.6	13.8	16.9	20.5
	Heating	Rated	A	10.4	14.4	18.3	23.6
EER / COP			kWh/kWh	4.42 / 4.50	3.85 / 4.10	3.50 / 3.71	3.20 / 3.25
SEER / SCOP			kWh/kWh	7.6 / 4.5	7.4 / 4.5	6.8 / 4.5	6.6 / 4.5
Pdesign	Cooling @ 35°C		kW	9.5	12.1	13.4	15
	Heating @ -10°C		kW	9.5	9.5	9.5	9.5
Seasonal Energy Label	Cooling / Heating		-	A++ / A+	- / -	- / -	- / -
Annual Energy Consumption	Cooling / Heating		kWh	437 / 2,956	981 / 2,956	1,182 / 2,956	1,364 / 2,956
Dehumidification Rate			l/h	2.6	4.8	5.3	6.9
ODU Sound Pressure Level	Cooling / Heating	Rated	dB(A)	50 / 50	51 / 52	52 / 53	54 / 54
ODU Sound Power Level	Cooling	Rated	dB(A)	66	69	69	71
Piping Connections	Liquid		mm (inch)	Ø9.52 (3/8)	Ø9.52 (3/8)	Ø9.52 (3/8)	Ø9.52 (3/8)
	Gas		mm (inch)	Ø15.88 (5/8)	Ø15.88 (5/8)	Ø15.88 (5/8)	Ø15.88 (5/8)
Connections Method			-	Flared	Flared	Flared	Flared
Operation Range (Outdoor)	Cooling	Min. / Max.	°C	-20 / 52	-20 / 52	-20 / 52	-20 / 52
	Heating	Min. / Max.	°C	-25 / 18	-25 / 18	-25 / 18	-25 / 18
INDOOR				UT36FH NAO	UT42FH NAO	UT48FH NAO	UT60FH NAO
Power Supply			Ø / V / Hz	1 / 220-240 / 50	1 / 220-240 / 50	1 / 220-240 / 50	1 / 220-240 / 50
Power Input (IDU)		H / M / L	W	70 / 59 / 50	70 / 59 / 50	81 / 60 / 50	81 / 60 / 50
Air Flow Rate		H / M / L	m³/min	28 / 25 / 23	28 / 25 / 23	30 / 27 / 24	30 / 27 / 24
Dimensions	Body	W x H x D	mm	840 x 288 x 840	840 x 288 x 840	840 x 288 x 840	840 x 288 x 840
Weight	Body		kg	27.2	27.2	27.2	27.2
Sound Pressure Level	Cooling	H / M / L	dB(A)	44 / 42 / 41	44 / 42 / 41	45 / 43 / 41	45 / 43 / 41
Sound Power Level	Cooling	Max.	dB(A)	59	59	61	61
Piping Connections	Drain	O.D. / I.D.	mm	Ø32.0 / 25.0	Ø32.0 / 25.0	Ø32.0 / 25.0	Ø32.0 / 25.0
Recommended Decoration Panel*	Model Name		-	PT-AFGW0	PT-AFGW0	PT-AFGW0	PT-AFGW0
	Color		-	White	White	White	White
	Dimensions	Body	mm	950 x 35 x 950	950 x 35 x 950	950 x 35 x 950	950 x 35 x 950
	Weight	Body	kg	7.5	7.5	7.5	7.5
OUTDOOR				UUD1 U30			
Power Supply			Ø / V / Hz	1 / 220-240 / 50			
Circuit Breaker		Min.	A	40			
Power Supply Cable (Included Earth)			No x mm³	3C x 6.0			
Dimensions	Net	W x H x D	mm	950 x 1,380 x 330			
Weight	Net		kg	85.0			
Compressor	Type		-	Inverter Scroll			
	Type		-	R32			
Refrigerant	GWP (Global Warming Potential)		-	675			
	Precharged Amount		kg	3.0			
	t-CO ₂ eq		-	2.025			
	Additional Charge (After 7.5m)		g/m	40			
Fan	Air Flow Rate	Rated	m³/min x No.	55 x 2			
Total Piping Length		Min. / Max.	m	5 / 85			
Piping Elevation	IDU - ODU	Max.	m	30			

* Decoration panel can be selected as an optional accessory. Note :

- Due to our policy of innovation some specifications may be changed without notification.
- Performances are based on the following conditions (It is accordance with EN14511)
 - Cooling : Indoor Ambient Temp 27°C DB / 19°C WB, Outdoor Ambient Temp 35°C DB / 24°C WB
 - Heating : Indoor Ambient Temp 20°C DB / 15°C WB, Outdoor Ambient Temp 7°C DB / 6°C WB
 - Interconnected Pipe is standard length and difference of Elevation (Outdoor - Indoor Unit) is 0m.
- Sound Level Values are measured at Noise Measuring chamber accordance with standard. Therefore, these values depend on the ambient conditions and values are normally higher in actual operation.
- This product contains fluorinated greenhouse gases. (R32)

H-INVERTER (R32)

UT36FH / UT42FH / UT48FH / UT60FH



LG participates in the ECP programme for EUROVENT AC program. Check ongoing validity of certification : www.eurovent-certification.com

UUD3 U30



COMBINATION				36	42	48	60
Capacity	Cooling	Min. / Rated / Max.	kW	3.8 / 9.5 / 12.8	4.8 / 12.1 / 14.5	5.4 / 13.4 / 16.1	6.0 / 15.0 / 16.2
	Heating	Min. / Rated / Max.	kW	4.3 / 10.8 / 13.7	5.4 / 13.5 / 16.2	6.2 / 15.5 / 17.8	7.0 / 17.5 / 19.3
Power Input (Set)	Cooling	Min. / Rated / Max.	kW	0.40 / 2.15 / 3.23	0.60 / 3.14 / 4.24	0.80 / 3.83 / 5.17	0.90 / 4.69 / 5.25
	Heating	Min. / Rated / Max.	kW	0.50 / 2.40 / 3.36	0.70 / 3.29 / 4.28	0.80 / 4.18 / 5.24	1.10 / 5.38 / 6.19
Running Current	Cooling	Rated	A	3.6	4.9	6.0	7.3
	Heating	Rated	A	3.8	5.1	6.5	8.2
EER / COP			kWh/kWh	4.42 / 4.50	3.85 / 4.10	3.50 / 3.71	3.20 / 3.25
SEER / SCOP			kWh/kWh	7.6 / 4.5	7.4 / 4.5	6.8 / 4.5	6.6 / 4.5
Pdesign	Cooling @ 35°C		kW	9.5	12.1	13.4	15
	Heating @ -10°C		kW	9.5	9.5	9.5	9.5
Seasonal Energy Label	Cooling / Heating		-	A++ / A+	- / -	- / -	- / -
Annual Energy Consumption	Cooling / Heating		kWh	437 / 2,956	981 / 2,956	1,182 / 2,956	1,364 / 2,956
Dehumidification Rate			l/h	2.6	4.8	5.3	6.9
ODU Sound Pressure Level	Cooling / Heating	Rated	dB(A)	50 / 50	51 / 52	52 / 53	54 / 54
ODU Sound Power Level	Cooling	Rated	dB(A)	66	69	69	71
Piping Connections	Liquid		mm (inch)	Ø9.52 (3/8)	Ø9.52 (3/8)	Ø9.52 (3/8)	Ø9.52 (3/8)
	Gas		mm (inch)	Ø15.88 (5/8)	Ø15.88 (5/8)	Ø15.88 (5/8)	Ø15.88 (5/8)
Connections Method			-	Flared	Flared	Flared	Flared
Operation Range (Outdoor)	Cooling	Min. / Max.	°C	-20 / 52	-20 / 52	-20 / 52	-20 / 52
	Heating	Min. / Max.	°C	-25 / 18	-25 / 18	-25 / 18	-25 / 18
INDOOR				UT36FH NAO	UT42FH NAO	UT48FH NAO	UT60FH NAO
Power Supply			Ø / V / Hz	1 / 220-240 / 50	1 / 220-240 / 50	1 / 220-240 / 50	1 / 220-240 / 50
Power Input (IDU)		H / M / L	W	70 / 59 / 50	70 / 59 / 50	81 / 60 / 50	81 / 60 / 50
Air Flow Rate		H / M / L	m³/min	28 / 25 / 23	28 / 25 / 23	30 / 27 / 24	30 / 27 / 24
Dimensions	Body	W x H x D	mm	840 x 288 x 840	840 x 288 x 840	840 x 288 x 840	840 x 288 x 840
Weight	Body		kg	27.2	27.2	27.2	27.2
Sound Pressure Level	Cooling	H / M / L	dB(A)	44 / 42 / 41	44 / 42 / 41	45 / 43 / 41	45 / 43 / 41
Sound Power Level	Cooling	Max.	dB(A)	59	59	61	61
Piping Connections	Drain	O.D. / I.D.	mm	Ø32.0 / 25.0	Ø32.0 / 25.0	Ø32.0 / 25.0	Ø32.0 / 25.0
Recommended Decoration Panel*	Model Name		-	PT-AFGW0	PT-AFGW0	PT-AFGW0	PT-AFGW0
	Color		-	White	White	White	White
	Dimensions	Body	mm	950 x 35 x 950	950 x 35 x 950	950 x 35 x 950	950 x 35 x 950
	Weight	Body	kg	7.5	7.5	7.5	7.5
OUTDOOR				UUD3 U30			
Power Supply			Ø / V / Hz	3 / 380-415 / 50			
Circuit Breaker		Min.	A	20			
Power Supply Cable (Included Earth)			No x mm³	5C x 2.5			
Dimensions	Net	W x H x D	mm	950 x 1,380 x 330			
Weight	Net		kg	85			
Compressor	Type		-	Inverter Scroll			
	Type		-	R32			
Refrigerant	GWP (Global Warming Potential)		-	675			
	Precharged Amount		kg	3.0			
	t-CO ₂ eq		-	2.025			
	Additional Charge (After 7.5m)		g/m	40			
Fan	Air Flow Rate	Rated	m³/min x No.	55 x 2			
Total Piping Length		Min. / Max.	m	5 / 85			
Piping Elevation	IDU - ODU	Max.	m	30			

* Decoration panel can be selected as an optional accessory. Note :

- Due to our policy of innovation some specifications may be changed without notification.
- Performances are based on the following conditions (It is accordance with EN14511)
 - Cooling : Indoor Ambient Temp 27°C DB / 19°C WB, Outdoor Ambient Temp 35°C DB / 24°C WB
 - Heating : Indoor Ambient Temp 20°C DB / 15°C WB, Outdoor Ambient Temp 7°C DB / 6°C WB
 - Interconnected Pipe is standard length and difference of Elevation (Outdoor - Indoor Unit) is 0m.
- Sound Level Values are measured at Noise Measuring chamber accordance with standard. Therefore, these values depend on the ambient conditions and values are normally higher in actual operation.
- This product contains fluorinated greenhouse gases. (R32)

STANDARD INVERTER (R32)

CT09F / CT12F / CT18F



LG participates in the ECP programme for EUROVENT AC program. Check ongoing validity of certification : www.eurovent-certification.com

UUA1 ULO UUB1 U20



COMBINATION				9	12	18
Capacity	Cooling	Min. / Rated / Max.	kW	1.5 / 2.5 / 3.2	1.5 / 3.4 / 4.5	2.0 / 5.0 / 5.8
	Heating	Min. / Rated / Max.	kW	1.8 / 3.2 / 3.7	1.8 / 4.1 / 5.0	2.3 / 5.7 / 6.6
Power Input (Set)	Cooling	Min. / Rated / Max.	kW	0.30 / 0.61 / 0.87	0.30 / 0.98 / 1.62	0.30 / 1.57 / 2.20
	Heating	Min. / Rated / Max.	kW	0.30 / 0.75 / 0.89	0.30 / 1.11 / 1.57	0.30 / 1.52 / 2.13
Running Current	Cooling	Rated	A	2.7	4.4	8.0
	Heating	Rated	A	3.3	4.9	7.8
EER / COP			kWh/kWh	4.10 / 4.30	3.50 / 3.71	3.19 / 3.74
SEER / SCOP			kWh/kWh	6.7 / 4.0	6.7 / 4.0	6.4 / 4.3
Pdesign	Cooling @ 35°C		kW	2.5	3.4	5
	Heating @ -10°C		kW	2.8	2.8	4.1
Seasonal Energy Label	Cooling / Heating		-	A++ / A+	A++ / A+	A++ / A+
Annual Energy Consumption	Cooling / Heating		kWh	131 / 980	178 / 980	273 / 1,335
Dehumidification Rate			l/h	0.63	1.26	1.89
ODU Sound Pressure Level	Cooling / Heating	Rated	dB(A)	49 / 52	49 / 52	47 / 52
ODU Sound Power Level	Cooling	Rated	dB(A)	65	65	63
Piping Connections	Liquid		mm (inch)	Ø6.35 (1/4)	Ø6.35 (1/4)	Ø6.35 (1/4)
	Gas		mm (inch)	Ø9.52 (3/8)	Ø9.52 (3/8)	Ø12.7 (1/2)
	Connections Method		-	Flared	Flared	Flared
Operation Range (Outdoor)	Cooling	Min. / Max.	°C	-15 / 50	-15 / 50	-15 / 50
	Heating	Min. / Max.	°C	-20 / 18	-20 / 18	-20 / 18
INDOOR				CT09F NRO	CT12F NRO	CT18F NQ0
Power Supply			Ø / V / Hz	1 / 220-240 / 50	1 / 220-240 / 50	1 / 220-240 / 50
Power Input (IDU)		H / M / L	W	26 / 22 / 19	28 / 24 / 20	30 / 26 / 22
Air Flow Rate		H / M / L	m³/min	8.5 / 7.0 / 6.0	9.5 / 8.0 / 7.0	13 / 12 / 11
Dimensions	Body	W x H x D	mm	570 x 214 x 570	570 x 214 x 570	570 x 256 x 570
	Weight		kg	12.4	12.4	13.9
Sound Pressure Level	Cooling	H / M / L	dB(A)	36 / 33 / 30	38 / 35 / 32	41 / 39 / 37
Sound Power Level	Cooling	Max.	dB(A)	52	52	57
Piping Connections	Drain	O.D. / I.D.	mm	Ø32.0 / 25.0	Ø32.0 / 25.0	Ø32.0 / 25.0
Recommended Decoration Panel*	Model Name		-	PT-QAGW0	PT-QAGW0	PT-QAGW0
	Color		-	White	White	White
	Dimensions	Body	mm	620 x 34 x 620	620 x 34 x 620	620 x 34 x 620
	Weight	Body	kg	3.0	3.0	3.0
OUTDOOR				UUA1 ULO	UUB1 U20	
Power Supply			Ø / V / Hz	1 / 220-240 / 50	1 / 220-240 / 50	
Circuit Breaker		Min.	A	15	20	
Power Supply Cable (Included Earth)			No x mm³	3C x 1.5	3C x 2.5	
Dimensions	Net	W x H x D	mm	770 x 545 x 288	870 x 650 x 330	
	Weight	Net	kg	33.3	44.5	
Compressor	Type		-	Twin Rotary	Twin Rotary	
	Type		-	R32	R32	
	GWP (Global Warming Potential)		-	675	675	
	Precharged Amount		kg	1.0	1.2	
Refrigerant	t-CO ₂ eq		-	0.675	0.81	
	Additional Charge (After 7.5m)		g/m	20	20	
	Fan	Air Flow Rate	Rated	m³/min x No.	28 x 1	50 x 1
Total Piping Length		Min. / Max.	m	5 / 30	5 / 30	
Piping Elevation	IDU - ODU	Max.	m	30	30	

* Decoration panel can be selected as an optional accessory. Note :

- Due to our policy of innovation some specifications may be changed without notification.
- Performances are based on the following conditions (It is accordance with EN14511)
 - Cooling : Indoor Ambient Temp 27°C DB / 19°C WB, Outdoor Ambient Temp 35°C DB / 24°C WB
 - Heating : Indoor Ambient Temp 20°C DB / 15°C WB, Outdoor Ambient Temp 7°C DB / 6°C WB
 - Interconnected Pipe is standard length and difference of Elevation (Outdoor - Indoor Unit) is 0m.
- Sound Level Values are measured at Noise Measuring chamber accordance with standard. Therefore, these values depend on the ambient conditions and values are normally higher in actual operation.
- This product contains fluorinated greenhouse gases. (R32)

STANDARD INVERTER (R32)

CT24F / UT30F



LG participates in the ECP programme for EUROVENT AC program. Check ongoing validity of certification : www.eurovent-certification.com

UUC1 U40



COMBINATION				24	30
Capacity	Cooling	Min. / Rated / Max.	kW	2.7 / 6.8 / 8.0	3.2 / 8.0 / 9.2
	Heating	Min. / Rated / Max.	kW	3.0 / 7.5 / 9.0	3.6 / 8.9 / 10.1
Power Input (Set)	Cooling	Min. / Rated / Max.	kW	0.40 / 1.93 / 2.66	0.50 / 2.45 / 3.14
	Heating	Min. / Rated / Max.	kW	0.40 / 1.96 / 2.84	0.50 / 2.62 / 3.25
Running Current	Cooling	Rated	A	8.6	10.9
	Heating	Rated	A	8.7	11.6
EER / COP			kWh/kWh	3.52 / 3.83	3.27 / 3.40
SEER / SCOP			kWh/kWh	7.4 / 4.3	7.1 / 4.3
Pdesign	Cooling @ 35°C		kW	6.8	8
	Heating @ -10°C		kW	5.6	5.6
Seasonal Energy Label	Cooling / Heating		-	A++ / A+	A++ / A+
Annual Energy Consumption	Cooling / Heating		kWh	322 / 1,823	394 / 1,823
Dehumidification Rate			l/h	2.8	2.8
ODU Sound Pressure Level	Cooling / Heating	Rated	dB(A)	48 / 52	50 / 52
ODU Sound Power Level	Cooling	Rated	dB(A)	65	68
Piping Connections	Liquid		mm (inch)	Ø9.52 (3/8)	Ø9.52 (3/8)
	Gas		mm (inch)	Ø15.88 (5/8)	Ø15.88 (5/8)
	Connections Method		-	Flared	Flared
Operation Range (Outdoor)	Cooling	Min. / Max.	°C	-20 / 50	-20 / 50
	Heating	Min. / Max.	°C	-20 / 18	-20 / 18
INDOOR				CT24F NBO	UT30F NBO
Power Supply			Ø / V / Hz	1 / 220-240 / 50	1 / 220-240 / 50
Power Input (IDU)		H / M / L	W	36 / 26 / 21	40 / 33 / 26
Air Flow Rate		H / M / L	m³/min	18 / 15.5 / 14	19 / 17 / 15.5
Dimensions	Body	W x H x D	mm	840 x 204 x 840	840 x 204 x 840
	Weight		kg	21.1	21.1
Sound Pressure Level	Cooling	H / M / L	dB(A)	38 / 36 / 34	40 / 37 / 35
Sound Power Level	Cooling	Max.	dB(A)	53	57
Piping Connections	Drain	O.D. / I.D.	mm	Ø32.0 / 25.0	Ø32.0 / 25.0
Recommended Decoration Panel*	Model Name		-	PT-AAGW0	PT-AAGW0
	Color		-	White	White
	Dimensions	Body	mm	950 x 35 x 950	950 x 35 x 950
	Weight	Body	kg	7.1	7.1
OUTDOOR				UUC1 U40	
Power Supply			Ø / V / Hz	1 / 220-240 / 50	
Circuit Breaker		Min.	A	25	
Power Supply Cable (Included Earth)			No x mm³	3C x 2.5	
Dimensions	Net	W x H x D	mm	950 x 834 x 330	
	Weight	Net	kg	57.7	
Compressor	Type		-	Twin Rotary	
	Type		-	R32	
	GWP (Global Warming Potential)		-	675	
	Precharged Amount		kg	1.9	
Refrigerant	t-CO ₂ eq		-	1.283	
	Additional Charge (After 7.5m)		g/m	40	
	Fan	Air Flow Rate	Rated	m³/min x No.	58 x 1
Total Piping Length		Min. / Max.	m	5 / 50	
Piping Elevation	IDU - ODU	Max.	m	30	

* Decoration panel can be selected as an optional accessory. Note :

- Due to our policy of innovation some specifications may be changed without notification.
- Performances are based on the following conditions (It is accordance with EN14511)
 - Cooling : Indoor Ambient Temp 27°C DB / 19°C WB, Outdoor Ambient Temp 35°C DB / 24°C WB
 - Heating : Indoor Ambient Temp 20°C DB / 15°C WB, Outdoor Ambient Temp 7°C DB / 6°C WB
 - Interconnected Pipe is standard length and difference of Elevation (Outdoor - Indoor Unit) is 0m.
- Sound Level Values are measured at Noise Measuring chamber accordance with standard. Therefore, these values depend on the ambient conditions and values are normally higher in actual operation.
- This product contains fluorinated greenhouse gases. (R32)

STANDARD INVERTER (R32)

UT36F / UT42F / UT48F / UT60F



LG participates in the ECP programme for EUROVENT AC program. Check ongoing validity of certification : www.eurovent-certification.com

UUD1 U30



COMBINATION				36	42	48	60
Capacity	Cooling	Min. / Rated / Max.	kW	3.8 / 9.5 / 12.5	4.8 / 12.1 / 14.2	5.4 / 13.4 / 15.7	5.8 / 14.6 / 15.8
	Heating	Min. / Rated / Max.	kW	4.3 / 10.8 / 13.4	5.4 / 13.5 / 15.8	6.2 / 15.5 / 17.5	6.8 / 16.9 / 18.3
Power Input (Set)	Cooling	Min. / Rated / Max.	kW	0.50 / 2.26 / 3.44	0.70 / 3.31 / 4.30	0.90 / 4.25 / 5.53	1.00 / 5.21 / 5.84
	Heating	Min. / Rated / Max.	kW	0.50 / 2.43 / 3.30	0.70 / 3.51 / 4.56	0.90 / 4.37 / 5.33	1.00 / 5.12 / 5.89
Running Current	Cooling	Rated	A	10.1	14.6	18.7	23.1
	Heating	Rated	A	10.7	15.0	19.0	22.7
EER / COP			kWh/kWh	4.20 / 4.45	3.66 / 3.85	3.15 / 3.55	2.80 / 3.30
SEER / SCOP			kWh/kWh	7.0 / 4.3	7.0 / 4.3	6.5 / 4.2	6.2 / 4.2
Pdesign	Cooling @ 35°C		kW	9.5	12.1	13.4	14.6
	Heating @ -10°C		kW	9.5	9.5	9.5	9.5
Seasonal Energy Label	Cooling / Heating		-	A++ / A+	- / -	- / -	- / -
Annual Energy Consumption	Cooling / Heating		kWh	475 / 3,093	1,037 / 3,093	1,237 / 3,167	1,413 / 3,167
Dehumidification Rate			l/h	2.4	4.5	5.7	6.6
ODU Sound Pressure Level	Cooling / Heating	Rated	dB(A)	50 / 50	51 / 52	52 / 53	54 / 54
ODU Sound Power Level	Cooling	Rated	dB(A)	66	69	69	71
Piping Connections	Liquid		mm (inch)	Ø9.52 (3/8)	Ø9.52 (3/8)	Ø9.52 (3/8)	Ø9.52 (3/8)
	Gas		mm (inch)	Ø15.88 (5/8)	Ø15.88 (5/8)	Ø15.88 (5/8)	Ø15.88 (5/8)
Connections Method			-	Flared	Flared	Flared	Flared
Operation Range (Outdoor)	Cooling	Min. / Max.	°C	-20 / 52	-20 / 52	-20 / 52	-20 / 52
	Heating	Min. / Max.	°C	-25 / 18	-25 / 18	-25 / 18	-25 / 18
INDOOR				UT36F NAO	UT42F NAO	UT48F NAO	UT60F NAO
Power Supply			Ø / V / Hz	1 / 220-240 / 50	1 / 220-240 / 50	1 / 220-240 / 50	1 / 220-240 / 50
Power Input (IDU)		H / M / L	W	60 / 50 / 45	60 / 50 / 45	80 / 60 / 50	80 / 60 / 50
Air Flow Rate		H / M / L	m³/min	27.5 / 25 / 22.5	27.5 / 25 / 22.5	30 / 27.5 / 25	30 / 27.5 / 25
Dimensions	Body	W x H x D	mm	840 x 288 x 840	840 x 288 x 840	840 x 288 x 840	840 x 288 x 840
Weight	Body		kg	25.3	25.3	25.3	25.3
Sound Pressure Level	Cooling	H / M / L	dB(A)	44 / 42 / 41	44 / 42 / 41	46 / 44 / 42	46 / 44 / 42
Sound Power Level	Cooling	Max.	dB(A)	61	61	62	62
Piping Connections	Drain	O.D. / I.D.	mm	Ø32.0 / 25.0	Ø32.0 / 25.0	Ø32.0 / 25.0	Ø32.0 / 25.0
Recommended Decoration Panel*	Model Name		-	PT-AAGW0	PT-AAGW0	PT-AAGW0	PT-AAGW0
	Color		-	White	White	White	White
	Dimensions	Body	mm	950 x 35 x 950	950 x 35 x 950	950 x 35 x 950	950 x 35 x 950
	Weight	Body	kg	7.1	7.1	7.1	7.1
OUTDOOR				UUD1 U30			
Power Supply			Ø / V / Hz	1 / 220-240 / 50			
Circuit Breaker		Min.	A	40			
Power Supply Cable (Included Earth)			No x mm³	3C x 6.0			
Dimensions	Net	W x H x D	mm	950 x 1,380 x 330			
Weight	Net		kg	85.0			
Compressor	Type		-	Inverter Scroll			
	Type		-	R32			
	GWP (Global Warming Potential)		-	675			
	Precharged Amount		kg	3.0			
Refrigerant	t-CO ₂ eq		-	2.025			
	Additional Charge (After 7.5m)		g/m	40			
	Air Flow Rate	Rated	m³/min x No.	55 x 2			
Total Piping Length		Min. / Max.	m	5 / 85			
Piping Elevation	IDU - ODU	Max.	m	30			

* Decoration panel can be selected as an optional accessory.

Note :

- Due to our policy of innovation some specifications may be changed without notification.
- Performances are based on the following conditions (It is accordance with EN14511)
 - Cooling : Indoor Ambient Temp 27°C DB / 19°C WB, Outdoor Ambient Temp 35°C DB / 24°C WB
 - Heating : Indoor Ambient Temp 20°C DB / 15°C WB, Outdoor Ambient Temp 7°C DB / 6°C WB
 - Interconnected Pipe is standard length and difference of Elevation (Outdoor - Indoor Unit) is 0m.
- Sound Level Values are measured at Noise Measuring chamber accordance with standard. Therefore, these values depend on the ambient conditions and values are normally higher in actual operation.
- This product contains fluorinated greenhouse gases. (R32)

STANDARD INVERTER (R32)

UT36F / UT42F / UT48F / UT60F

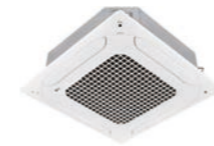

LG participates in the ECP programme for EUROVENT AC program. Check ongoing validity of certification : www.eurovent-certification.com

UUD3 U30



COMBINATION				36	42	48	60
Capacity	Cooling	Min. / Rated / Max.	kW	3.8 / 9.5 / 12.5	4.8 / 12.1 / 14.2	5.4 / 13.4 / 15.7	5.8 / 14.6 / 15.8
	Heating	Min. / Rated / Max.	kW	4.3 / 10.8 / 13.4	5.4 / 13.5 / 15.8	6.2 / 15.5 / 17.5	6.8 / 16.9 / 18.3
Power Input (Set)	Cooling	Min. / Rated / Max.	kW	0.50 / 2.26 / 3.44	0.70 / 3.31 / 4.30	0.90 / 4.25 / 5.53	1.00 / 5.21 / 5.84
	Heating	Min. / Rated / Max.	kW	0.50 / 2.43 / 3.30	0.70 / 3.51 / 4.56	0.90 / 4.37 / 5.33	1.00 / 5.12 / 5.89
Running Current	Cooling	Rated	A	3.8	5.2	6.6	8.1
	Heating	Rated	A	3.9	5.4	6.7	7.9
EER / COP			kWh/kWh	4.20 / 4.45	3.66 / 3.85	3.15 / 3.55	2.80 / 3.30
SEER / SCOP			kWh/kWh	7.0 / 4.3	7.0 / 4.3	6.5 / 4.2	6.2 / 4.2
Pdesign	Cooling @ 35°C		kW	9.5	12.1	13.4	14.6
	Heating @ -10°C		kW	9.5	9.5	9.5	9.5
Seasonal Energy Label	Cooling / Heating		-	A++ / A+	- / -	- / -	- / -
Annual Energy Consumption	Cooling / Heating		kWh	475 / 3,093	1,037 / 3,093	1,237 / 3,167	1,413 / 3,167
Dehumidification Rate			l/h	2.4	4.5	5.7	6.6
ODU Sound Pressure Level	Cooling / Heating	Rated	dB(A)	50 / 50	51 / 52	52 / 53	54 / 54
ODU Sound Power Level	Cooling	Rated	dB(A)	66	69	69	71
Piping Connections	Liquid		mm (inch)	Ø9.52 (3/8)	Ø9.52 (3/8)	Ø9.52 (3/8)	Ø9.52 (3/8)
	Gas		mm (inch)	Ø15.88 (5/8)	Ø15.88 (5/8)	Ø15.88 (5/8)	Ø15.88 (5/8)
Connections Method			-	Flared	Flared	Flared	Flared
Operation Range (Outdoor)	Cooling	Min. / Max.	°C	-20 / 52	-20 / 52	-20 / 52	-20 / 52
	Heating	Min. / Max.	°C	-25 / 18	-25 / 18	-25 / 18	-25 / 18
INDOOR				UT36F NAO	UT42F NAO	UT48F NAO	UT60F NAO
Power Supply			Ø / V / Hz	1 / 220-240 / 50	1 / 220-240 / 50	1 / 220-240 / 50	1 / 220-240 / 50
Power Input (IDU)		H / M / L	W	60 / 50 / 45	60 / 50 / 45	80 / 60 / 50	80 / 60 / 50
Air Flow Rate		H / M / L	m³/min	27.5 / 25 / 22.5	27.5 / 25 / 22.5	30 / 27.5 / 25	30 / 27.5 / 25
Dimensions	Body	W x H x D	mm	840 x 288 x 840	840 x 288 x 840	840 x 288 x 840	840 x 288 x 840
Weight	Body		kg	25.3	25.3	25.3	25.3
Sound Pressure Level	Cooling	H / M / L	dB(A)	44 / 42 / 41	44 / 42 / 41	46 / 44 / 42	46 / 44 / 42
Sound Power Level	Cooling	Max.	dB(A)	61	61	62	62
Piping Connections	Drain	O.D. / I.D.	mm	Ø32.0 / 25.0	Ø32.0 / 25.0	Ø32.0 / 25.0	Ø32.0 / 25.0
Recommended Decoration Panel*	Model Name		-	PT-AAGW0	PT-AAGW0	PT-AAGW0	PT-AAGW0
	Color		-	White	White	White	White
	Dimensions	Body	mm	950 x 35 x 950	950 x 35 x 950	950 x 35 x 950	950 x 35 x 950
	Weight	Body	kg	7.1	7.1	7.1	7.1
OUTDOOR				UUD3 U30			
Power Supply			Ø / V / Hz	3 / 380-415 / 50			
Circuit Breaker		Min.	A	20			
Power Supply Cable (Included Earth)			No x mm³	5C x 2.5			
Dimensions	Net	W x H x D	mm	950 x 1,380 x 330			
Weight	Net		kg	85.0			
Compressor	Type		-	Inverter Scroll			
	Type		-	R32			
	GWP (Global Warming Potential)		-	675			
	Precharged Amount		kg	3.0			
Refrigerant	t-CO ₂ eq		-	2.025			
	Additional Charge (After 7.5m)		g/m	40			
	Air Flow Rate	Rated	m³/min x No.	55 x 2			
Total Piping Length		Min. / Max.	m	5 / 85			
Piping Elevation	IDU - ODU	Max.	m	30			

* Decoration panel can be selected as an optional accessory.

Note :

- Due to our policy of innovation some specifications may be changed without notification.
- Performances are based on the following conditions (It is accordance with EN14511)
 - Cooling : Indoor Ambient Temp 27°C DB / 19°C WB, Outdoor Ambient Temp 35°C DB / 24°C WB
 - Heating : Indoor Ambient Temp 20°C DB / 15°C WB, Outdoor Ambient Temp 7°C DB / 6°C WB
 - Interconnected Pipe is standard length and difference of Elevation (Outdoor - Indoor Unit) is 0m.
- Sound Level Values are measured at Noise Measuring chamber accordance with standard. Therefore, these values depend on the ambient conditions and values are normally higher in actual operation.
- This product contains fluorinated greenhouse gases. (R32)

COMPACT INVERTER (R32)

CT18F / CT24F / UT30F / UT36F

UUA1 ULO

UUB1 U20

UUC1 U40



LG participates in the ECP programme for EUROVENT AC program. Check ongoing validity of certification : www.eurovent-certification.com

COMBINATION				18	24	30	36
Capacity	Cooling	Min. / Rated / Max.	kW	1.8 / 5.0 / 5.5	2.7 / 6.8 / 7.5	3.0 / 7.5 / 8.3	3.8 / 9.5 / 10.8
	Heating	Min. / Rated / Max.	kW	2.1 / 5.2 / 5.7	3.0 / 7.5 / 8.6	3.2 / 7.9 / 8.7	4.3 / 10.8 / 11.7
Power Input (Set)	Cooling	Min. / Rated / Max.	kW	0.34 / 1.76 / 2.11	0.40 / 2.00 / 2.40	0.50 / 2.31 / 2.77	0.60 / 2.79 / 3.57
	Heating	Min. / Rated / Max.	kW	0.30 / 1.45 / 1.87	0.40 / 2.21 / 2.87	0.50 / 2.37 / 3.08	0.60 / 2.77 / 3.30
Running Current	Cooling	Rated	A	7.8	8.8	10.1	12.4
	Heating	Rated	A	6.4	9.6	10.4	12.3
EER / COP			kWh/kWh	2.85 / 3.60	3.40 / 3.39	3.25 / 3.34	3.40 / 3.90
SEER / SCOP			kWh/kWh	6.3 / 3.9	7.0 / 4.2	6.8 / 4.2	6.7 / 4.3
Pdesign	Cooling @ 35°C		kW	5	6.8	7.5	9.5
	Heating @ -10°C		kW	2.8	4.1	4.1	5.6
Seasonal Energy Label	Cooling / Heating		-	A++ / A	A++ / A+	A++ / A+	A++ / A+
Annual Energy Consumption	Cooling / Heating		kWh	278 / 1,005	340 / 1,367	386 / 1,367	496 / 1,823
Dehumidification Rate			l/h	1.8	2.6	3.1	2.5
ODU Sound Pressure Level	Cooling / Heating	Rated	dB(A)	49 / 52	48 / 53	50 / 54	54 / 56
ODU Sound Power Level	Cooling	Rated	dB(A)	65	65	67	70
Piping Connections	Liquid		mm (inch)	Ø6.35 (1/4)	Ø9.52 (3/8)	Ø9.52 (3/8)	Ø9.52 (3/8)
	Gas		mm (inch)	Ø9.52 (3/8)	Ø15.88 (5/8)	Ø15.88 (5/8)	Ø15.88 (5/8)
Connections Method			-	Flared	Flared	Flared	Flared
Operation Range (Outdoor)	Cooling	Min. / Max.	°C	-10 / 50	-10 / 48	-10 / 48	-20 / 50
	Heating	Min. / Max.	°C	-10 / 18	-15 / 18	-15 / 18	-15 / 18
INDOOR				CT18F NQ0	CT24F NB0	UT30F NB0	UT36F NAO
Power Supply			Ø / V / Hz	1 / 220-240 / 50	1 / 220-240 / 50	1 / 220-240 / 50	1 / 220-240 / 50
Power Input (IDU)		H / M / L	W	30 / 26 / 22	36 / 26 / 21	40 / 33 / 26	60 / 50 / 45
Air Flow Rate		H / M / L	m³/min	13 / 12 / 11	18 / 15.5 / 14	19 / 17 / 15.5	27.5 / 25 / 22.5
Dimensions	Body	W x H x D	mm	570 x 256 x 570	840 x 204 x 840	840 x 204 x 840	840 x 288 x 840
	Weight		kg	13.9	21.1	21.1	25.3
Sound Pressure Level	Cooling	H / M / L	dB(A)	41 / 39 / 37	38 / 36 / 34	40 / 37 / 35	44 / 42 / 41
Sound Power Level	Cooling	Max.	dB(A)	57	53	57	61
Piping Connections	Drain	O.D. / I.D.	mm	Ø32.0 / 25.0	Ø32.0 / 25.0	Ø32.0 / 25.0	Ø32.0 / 25.0
Recommended Decoration Panel*	Model Name		-	PT-AAGW0	PT-AAGW0	PT-AAGW0	PT-AAGW0
	Color		-	White	White	White	White
	Dimensions	Body	mm	620 x 34 x 620	950 x 35 x 950	950 x 35 x 950	950 x 35 x 950
	Weight	Body	kg	3.0	7.1	7.1	7.1
OUTDOOR				UUA1 ULO	UUB1 U20	UUC1 U40	
Power Supply			Ø / V / Hz	1 / 220-240 / 50	1 / 220-240 / 50	1 / 220-240 / 50	
Circuit Breaker		Min.	A	15	20	25	
Power Supply Cable (Included Earth)			No x mm³	3C x 1.5	3C x 2.5	3C x 2.5	
Dimensions	Net	W x H x D	mm	770 x 545 x 288	870 x 650 x 330	950 x 834 x 330	
Weight	Net		kg	33.3	44.5	57.7	
Compressor	Type		-	Twin Rotary	Twin Rotary	Twin Rotary	
	Type		-	R32	R32	R32	
	GWP (Global Warming Potential)		-	675	675	675	
	Precharged Amount		kg	1.0	1.2	1.9	
Refrigerant	t-CO ₂ eq		-	0.675	0.81	1.283	
	Additional Charge (After 7.5m)		g/m	20	40	40	
Fan	Air Flow Rate	Rated	m³/min x No.	28 x 1	50 x 1	58 x 1	
Total Piping Length		Min. / Max.	m	5 / 30	5 / 35	5 / 50	
Piping Elevation	IDU - ODU	Max.	m	30	30	30	

* Decoration panel can be selected as an optional accessory.

Note :

- Due to our policy of innovation some specifications may be changed without notification.
- Performances are based on the following conditions (It is accordance with EN14511)
 - Cooling : Indoor Ambient Temp 27°C DB / 19°C WB, Outdoor Ambient Temp 35°C DB / 24°C WB
 - Heating : Indoor Ambient Temp 20°C DB / 15°C WB, Outdoor Ambient Temp 7°C DB / 6°C WB
 - Interconnected Pipe is standard length and difference of Elevation (Outdoor - Indoor Unit) is 0m.
- Sound Level Values are measured at Noise Measuring chamber accordance with standard. Therefore, these values depend on the ambient conditions and values are normally higher in actual operation.
- This product contains fluorinated greenhouse gases. (R32)

Cassette Panel



Model Name

- PT-AAGW0
- PT-AFGW0
- PT-QAGW0 (Mini 4 Way)

Key Features

Model	Dual Vane	Wi-Fi	Floor Temperature Sensor	Air Purification	Human Detection Sensor	Dust Sensor	Tact switch	Elevating Grille
PT-AAGW0	O	Optional	Optional	X	Optional	X	X	X
PT-AFGW0	O	Optional	Optional	Optional	Optional	O	O	X

Specification

Model	Suction Type	Color (RAL)	Gloss	Weight (kg)	Dimension (mm)		
					W	H	D
PT-AAGW0	Grid	White (RAL 9003)	-	7.1	950	35	950
PT-AFGW0	Grid	White (RAL 9003)	-	7.5	950	35	950
PT-QAGW0	Grid	White (RAL 9003)	-	3.0	620	34	620

Air Purification Kit

Model	Image	Model name	Dielectric Dust collecting filter	Photocatalytic Deodorizing filter	HVPS	Ionizer
Air cleaning kit		PTAHMPO	<input type="checkbox"/>	<input type="checkbox"/>	<input type="checkbox"/>	<input type="checkbox"/>

Cassette Cover

Cover in case of exposed cassette installation.

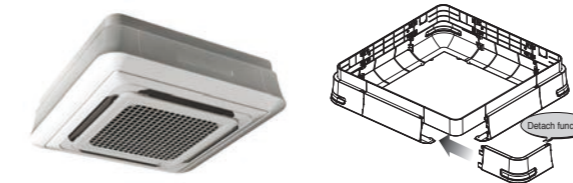

Model Name

PTDCQ / PTDCA*

* PTDCA suitable for Dual Vane 4 Way CST (840 x 840) will be available later.

Applied Products

4 Way Cassette (for chassis TQ, TR)

Included Parts

- Cover A, Cover B
- Cover C, Cover D
- Screws
- Installation Manual (for chassis TQ, TR)

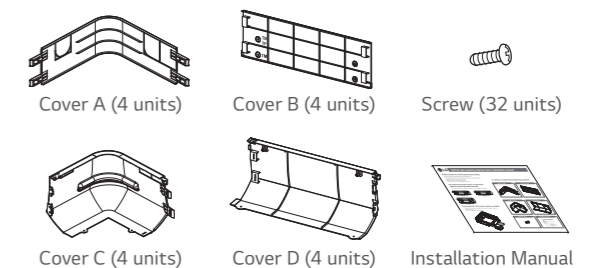

Key Features

- Specially designed for indoor unit
- Covers the side area of cassette
- Gives elegant looks
- Light weight

Specification

Model	Front Panel	Weight (kg)		Dimensions (mm)			
		NET	Gross	W	H	D	
PTDCQ	PT-UQC	TR	5.0	7.2	907	907	268
		TQ	5.0	7.2	907	907	310

ROUND CASSETTE



Slim and Compact Design

The LG Round Cassette's compact design makes the space look more spacious and secure.



※ Product : 11 / 13.4kW

Minimal Exposure Design

LG Round Cassette hides clunky parts into a smooth surface to provide harmony and aesthetic.

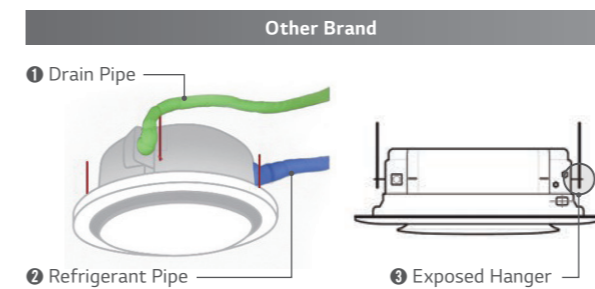

This air conditioning impresses with a sophisticated design and application concept that combines modern technology with a user-friendly operating comfort.

※ Red Dot Design Award : World's three major international design competitions, German Design Association (2019)
PIN UP Design Award : Korea Industrial Designers Association (Ministry of Trade, Industry and Energy) (2018)

6-Step Vane Control

Crystal vane allows for 6-step precision control for cool and warm airflow in every direction.

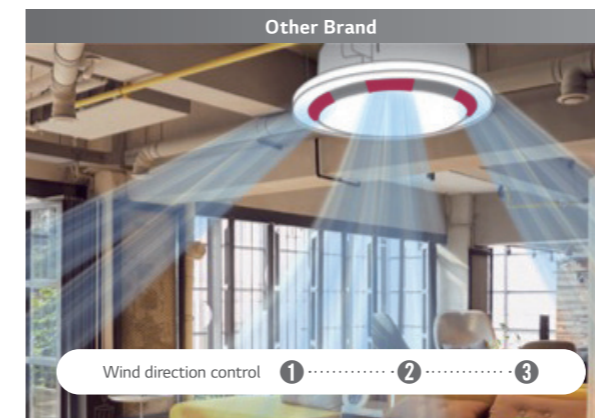

Perfect Round Airflow

Perfect round airflow without blind spots and 4 vanes can be controlled individually.

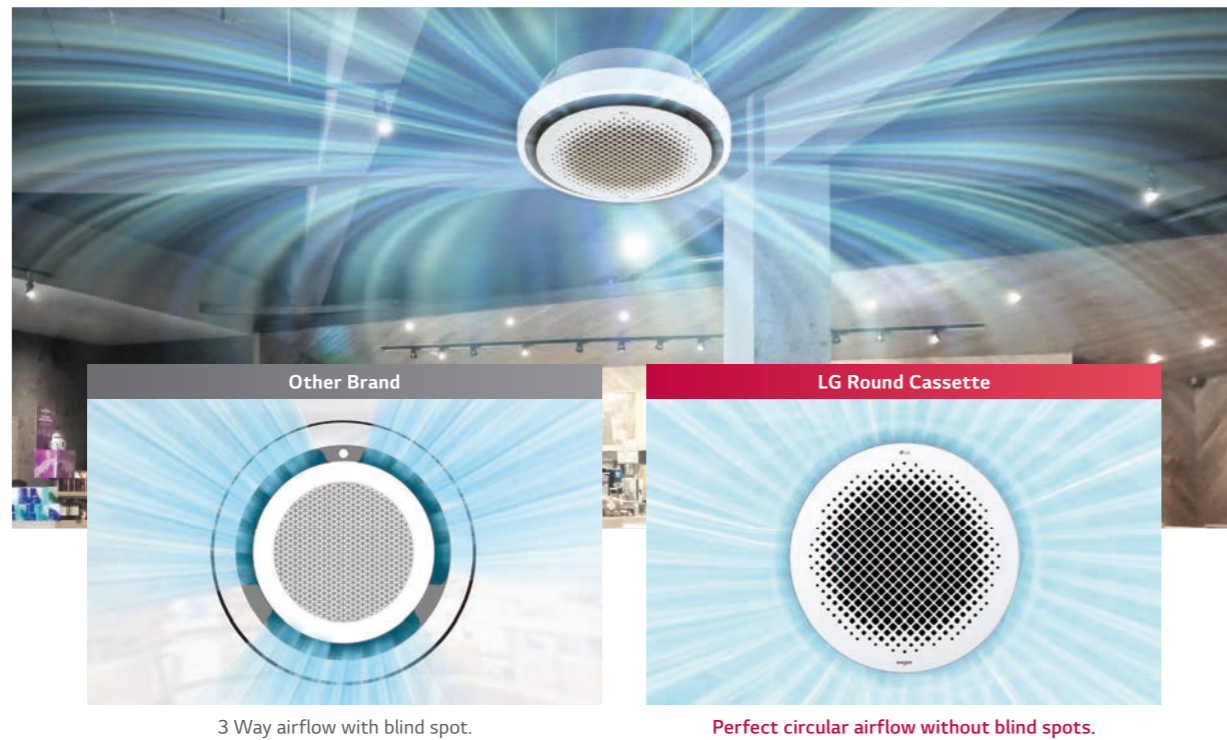

Quiet Operation

LG Round cassette makes the space quieter.

Sound Pressure



Normal communication Noise level 50dB(A)
Library Noise level 40dB(A)

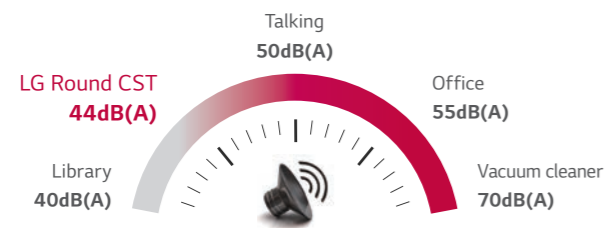

Sound Power

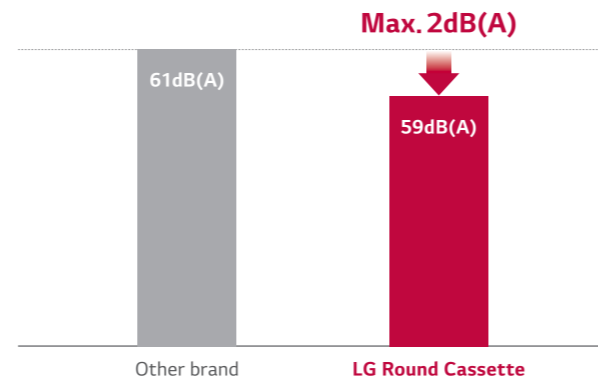

Sound power levels (cooling)_dB(A)

Other brand	LG Round Cassette
61	Max. 59

※ The value is based on the Sound pressure Level(Cooling), 11.0kW model

Faster in Cooling

Larger airflow rate, cooling rate is 30% faster the competition.

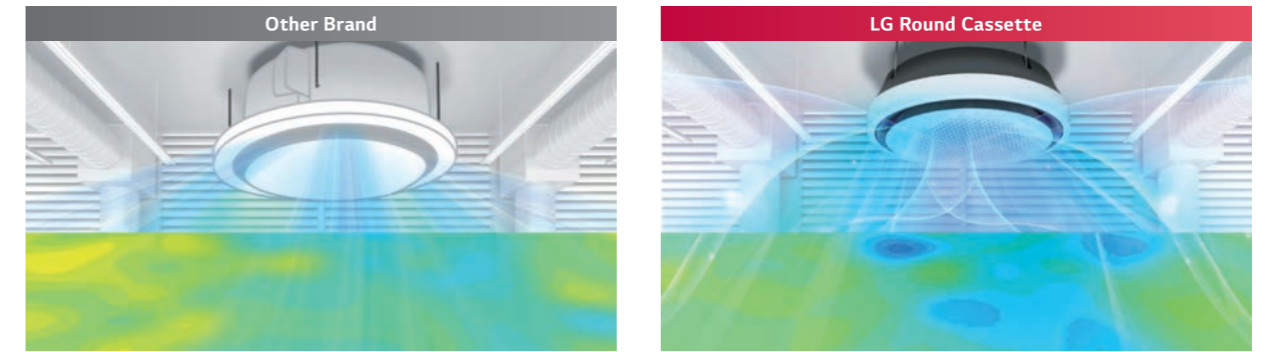

Set temperature reach time 18 minutes (Height 1.1m)
Set temperature reach time 12 minutes (Height 1.1m)
※ Based on test results from LG chamber, this image is designed to help customers understand.
Experimental environment : height 3.2m, cooling mode, high flow rate, horizontal air flow direction, initial temperature :33°C, setting temperature 26°C

Outside Control Box

The control box is located on the side for comfortable wiring and installation.



Inconvenient installation
Inside control box / hard to installation
Convenient installation
Outside control box / easy to installation

Embedded Humidity Sensor

Humidity sensor is included as standard, so comfort cooling function is possible without separate wired remote controller.

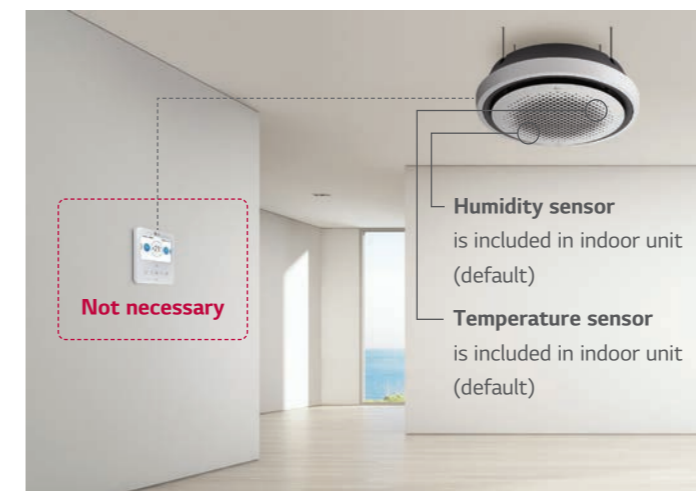

Simple Setting

- Press the 'Function' button repeatedly until 'comfort cooling icon' displayed



- Press the 'Set' button

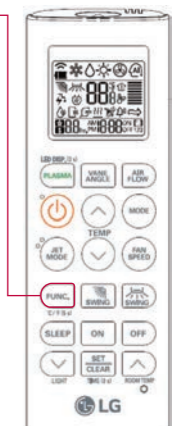

STANDARD INVERTER (R32)

UT36F NYO / UT48F NYO



LG participates in the ECP programme for EUROVENT AC program. Check ongoing validity of certification : www.eurovent-certification.com

UUD1 U30



COMBINATION				36	48
Capacity	Cooling	Min. / Rated / Max.	kW	3.80 / 11.00 / 12.54	5.40 / 13.40 / 15.68
	Heating	Min. / Rated / Max.	kW	4.30 / 12.20 / 13.39	6.20 / 15.50 / 17.52
Power Input (Set)	Cooling	Min. / Rated / Max.	kW	0.50 / 3.06 / 3.98	0.90 / 4.39 / 5.71
	Heating	Min. / Rated / Max.	kW	0.50 / 3.13 / 4.26	0.90 / 4.56 / 5.56
Running Current	Cooling	Rated	A	10.10	19.50
	Heating	Rated	A	10.70	20.20
EER / COP			kWh/kWh	3.60 / 3.90	3.05 / 3.40
SEER / SCOP			kWh/kWh	6.80 / 4.30	6.50 / 4.30
P Design	Cooling @ 35°C		kW	11.0	13.4
	Heating @-10°C		kW	9.0	9.0
Seasonal Energy Label	Cooling / Heating		-	- / -	- / -
Annual Energy Consumption	Cooling / Heating		kWh	566 / 2,930	1,237 / 2,930
Dehumidification Rate			ℓ/h	4.27	5.65
ODU Sound Pressure Level	Cooling / Heating	Rated	dB(A)	50 / 50	52 / 53
ODU Sound Power Level	Cooling / Heating	Rated	dB(A)	66 / -	69 / 69
Piping Connections	Liquid	Outer Dia.	mm (inch)	Ø 9.52 (3/8)	Ø 9.52 (3/8)
	Gas	Outer Dia.	mm (inch)	Ø 15.88 (5/8)	Ø 15.88 (5/8)
	Connections Method		-	Flare	Flare
Operation Range (Outdoor)	Cooling	Min. / Max.	°C	-20 / 52	-20 / 52
	Heating	Min. / Max.	°C	-25 / 18	-25 / 18
INDOOR				UT36F NYO	UT48F NYO
Power Supply			Ø / V / Hz	1 / 220-240 / 50	1 / 220-240 / 50
Power Input (IDU)		H / M / L	W	90 / 66 / 48	125 / 90 / 66
Air Flow Rate		H / M / L	m³/min	25.0 / 21.0 / 19.0	29.0 / 25.0 / 21.0
Dimensions	Body	W x H x D	mm	1,050 x 330 x 1,050	1,050 x 330 x 1,050
	Weight		kg	30.0	30.0
Sound Pressure Level	Cooling	H / M / L	dB(A)	44.0 / 40.0 / 38.0	47.0 / 44.0 / 40.0
	Heating	H / M / L	dB(A)	47.0 / 43.0 / 40.0	49.0 / 46.0 / 42.0
Sound Power Level	Cooling	Rated	dB(A)	59	60
	Heating	Rated	dB(A)	-	62
Piping Connections	Drain Pipe	O.D. / I.D.	mm	Ø 32.0 / 25.0	Ø 32.0 / 25.0
OUTDOOR				UUD1 U30	
Power Supply			Ø / V / Hz	1 / 220-240 / 50	
Circuit Breaker		Min.	A	40	
Power Supply Cable (included Earth)			No. x mm²	3C x 6.0	
Dimensions	Net	W x H x D	mm	950 x 1,380 x 330	
Weight	Net		kg	85.0	
Compressor	Type		-	LG Inverter Scroll	
	Type		-	R32	
Refrigerant	GWP (Global Warming Potential)		-	675	
	Precharged Amount		kg	3.0	
	t-CO ₂ eq.		-	2.025	
	Additional Charging Volume		g/m	40	
Fan	Air Flow Rate	Rated	m³/min x No.	55 x 2	
Total Piping Length		Min. / Max.	m	5 / 85	
Piping Elevation	IDU-ODU	Max.	m	30	

STANDARD INVERTER (R32)

UT36F NYO / UT48F NYO



LG participates in the ECP programme for EUROVENT AC program. Check ongoing validity of certification : www.eurovent-certification.com

UUD3 U30



COMBINATION				36	48
Capacity	Cooling	Min. / Rated / Max.	kW	3.80 / 11.00 / 12.54	5.40 / 13.40 / 15.68
	Heating	Min. / Rated / Max.	kW	4.30 / 12.20 / 13.39	6.20 / 15.50 / 17.52
Power Input (Set)	Cooling	Min. / Rated / Max.	kW	0.50 / 3.06 / 3.98	0.90 / 4.39 / 5.71
	Heating	Min. / Rated / Max.	kW	0.50 / 3.13 / 4.26	0.90 / 4.56 / 5.56
Running Current	Cooling	Rated	A	5.20	7.00
	Heating	Rated	A	5.30	7.30
EER / COP			kWh/kWh	3.60 / 3.90	3.05 / 3.40
SEER / SCOP			kWh/kWh	6.80 / 4.30	6.50 / 4.30
P Design	Cooling @ 35°C		kW	11.0	13.4
	Heating @-10°C		kW	9.0	9.0
Seasonal Energy Label	Cooling / Heating		-	- / -	- / -
Annual Energy Consumption	Cooling / Heating		kWh	566 / 2,931	1,237 / 2,931
Dehumidification Rate			ℓ/h	4.27	5.65
ODU Sound Pressure Level	Cooling / Heating	Rated	dB(A)	50 / 50	52 / 53
ODU Sound Power Level	Cooling / Heating	Rated	dB(A)	66 / -	69 / 69
Piping Connections	Liquid	Outer Dia.	mm (inch)	Ø 9.52 (3/8)	Ø 9.52 (3/8)
	Gas	Outer Dia.	mm (inch)	Ø 15.88 (5/8)	Ø 15.88 (5/8)
	Connections Method		-	Flare	Flare
Operation Range (Outdoor)	Cooling	Min. / Max.	°C	-20 / 52	-20 / 52
	Heating	Min. / Max.	°C	-25 / 18	-25 / 18
INDOOR				UT36F NYO	UT48F NYO
Power Supply			Ø / V / Hz	1 / 220-240 / 50	1 / 220-240 / 50
Power Input (IDU)		H / M / L	W	90 / 66 / 48	125 / 90 / 66
Air Flow Rate		H / M / L	m³/min	25.0 / 21.0 / 19.0	29.0 / 25.0 / 21.0
Dimensions	Body	W x H x D	mm	1,050 x 330 x 1,050	1,050 x 330 x 1,050
	Weight		kg	30.0	30.0
Sound Pressure Level	Cooling	H / M / L	dB(A)	44.0 / 40.0 / 38.0	47.0 / 44.0 / 40.0
	Heating	H / M / L	dB(A)	47.0 / 43.0 / 40.0	49.0 / 46.0 / 42.0
Sound Power Level	Cooling	Rated	dB(A)	59	60
	Heating	Rated	dB(A)	-	62
Piping Connections	Drain Pipe	O.D. / I.D.	mm	Ø 32.0 / 25.0	Ø 32.0 / 25.0
OUTDOOR				UUD3 U30	
Power Supply			Ø / V / Hz	3 / 380-415 / 50	
Circuit Breaker		Min.	A	20	
Power Supply Cable (included Earth)			No. x mm²	5C x 2.5	
Dimensions	Net	W x H x D	mm	950 x 1,380 x 330	
Weight	Net		kg	85.0	
Compressor	Type		-	LG Inverter Scroll	
	Type		-	R32	
Refrigerant	GWP (Global Warming Potential)		-	675	
	Precharged Amount		kg	3.0	
	t-CO ₂ eq.		-	2.025	
	Additional Charging Volume		g/m	40	
Fan	Air Flow Rate	Rated	m³/min x No.	55 x 2	
Total Piping Length		Min. / Max.	m	5 / 85	
Piping Elevation	IDU-ODU	Max.	m	30	

CEILING CONCEALED DUCT



External Static Pressure (ESP) Control

User has easy access to air volume selection via remote controller using the ESP control function. The BLDC motor can control fan speed and air volume. No additional accessories are necessary to control air flow.

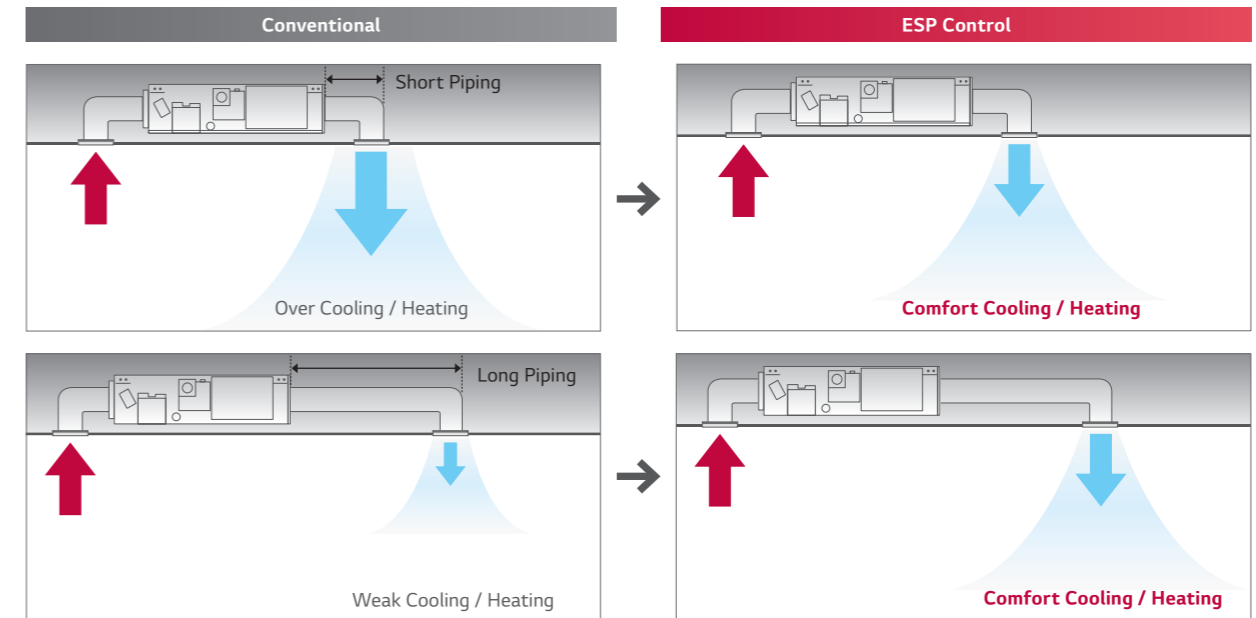

High Head Drain Pump

High head drain pump automatically drains water up to a height of 700mm of drain-head height. It provides the perfect solution for draining of water.

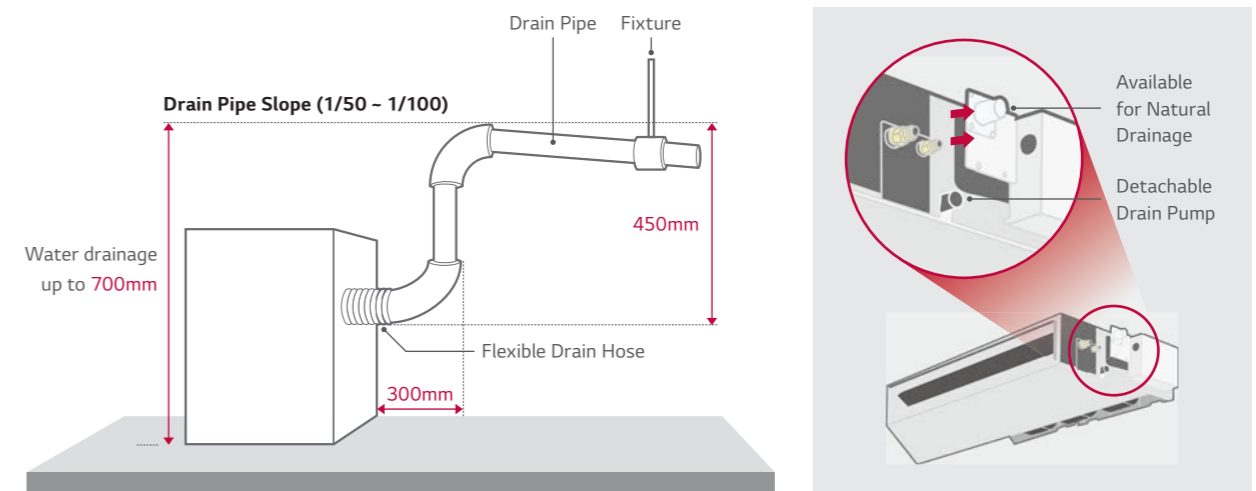

※ Standard Inverter : Accessory (ABDPG) / Low-Static Duct : Included
 ※ Required by option for Standard / Compact Inverter high static pressure models.

Two Thermistors Control

The indoor temperature can be checked using the thermistors in the remote controller as well as from the indoor unit. There may be a significant difference between ceiling and floor air temperature. Two thermistors can optimize indoor air temperature for a more comfortable environment.

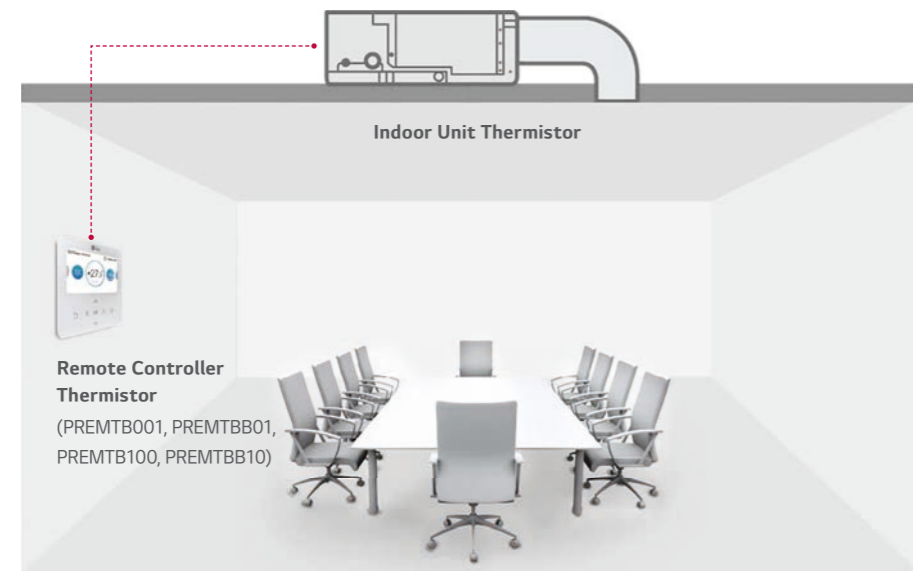

Compares temperatures sensed from different positions, and automatically selects the optimum temperature for users.

Operation for Multiple Rooms

Using a spiral duct (embedded or flexible type) and stream chamber, it is possible to operate cooling / heating for several rooms simultaneously. Also, zone control is available with zone controller accessory. (ABZCA)

Zone control features

- Controls different zones (Up to 4 zones) by external thermostat (AC 24V)
- Maintain proper air volume of each zone
- Auto variation of dampers
- Auto control of fan speed and On / Off operation

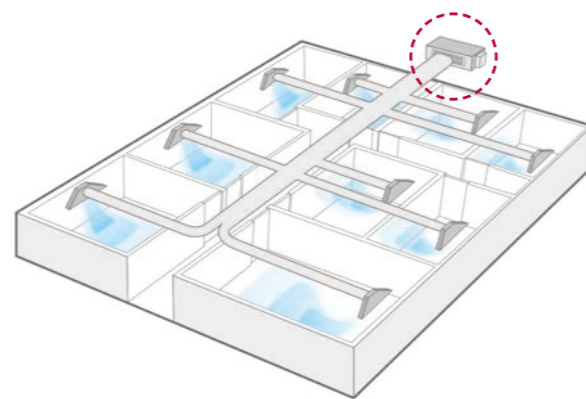
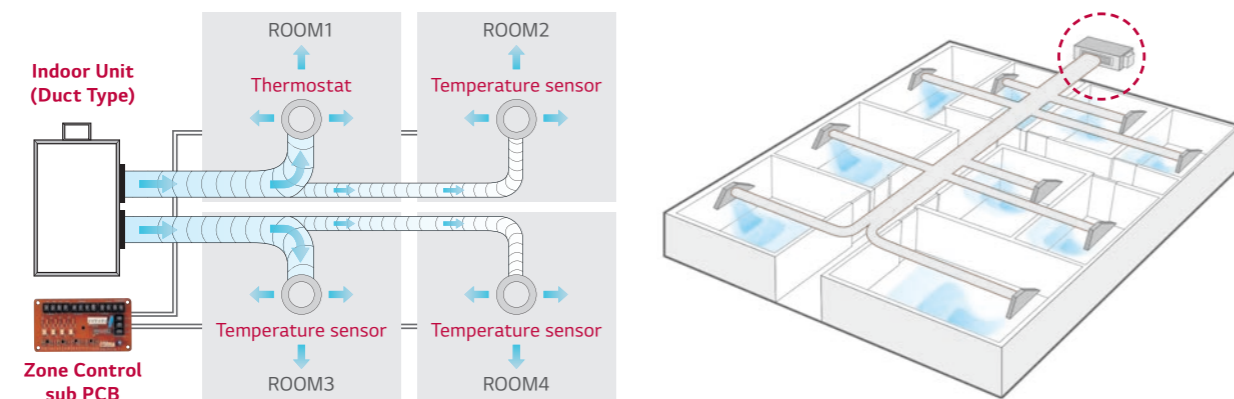

Minimized Height and Depth

New Low Static ducts provide ideal solution for installation in limited space.

Low Static Duct

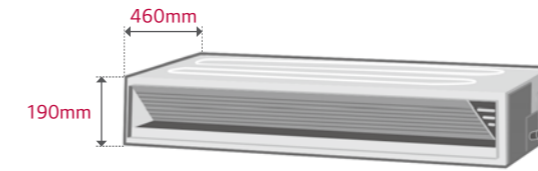

※ CL09F N50, CL12F N50, CL18F N60, UL12FH N50 only

Depth

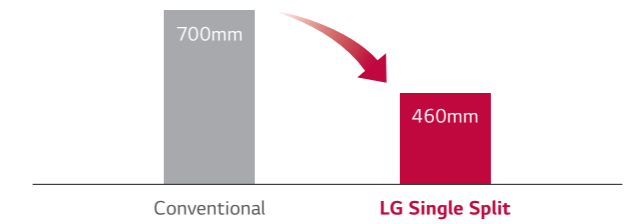

※ 2.5 / 3.4 / 5 kW

Wide Operation Range

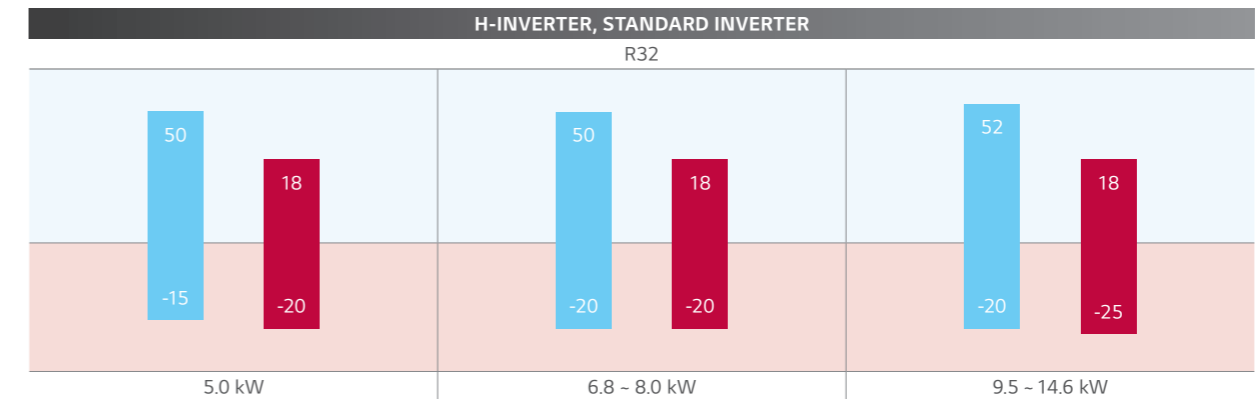

■ Outdoor temperature for cooling operation (°C DB) ■ Outdoor temperature for heating operation (°C WB)

Easy Service & Maintenance

Users are not required to disassemble the whole panel for maintenance; since panel is divided into 2 components; one for heat exchanger and the other for fan / motor. The user can easily detach and re-attach the filter in the available limited space.

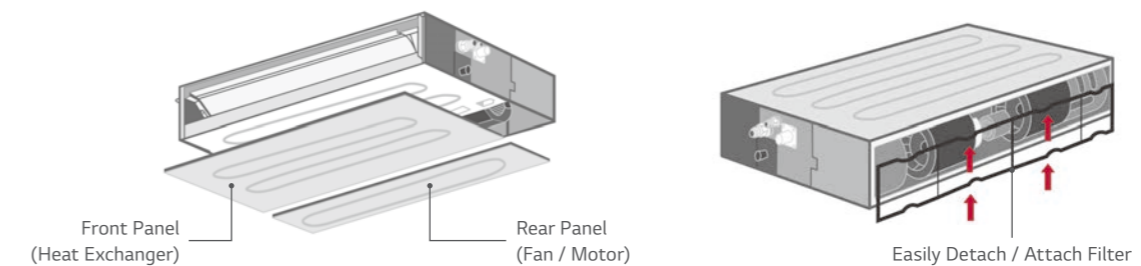

Quiet Operation (Low Static Pressure Model)

The noise level of low static ducts have been reduced, even though ESP has been increased.

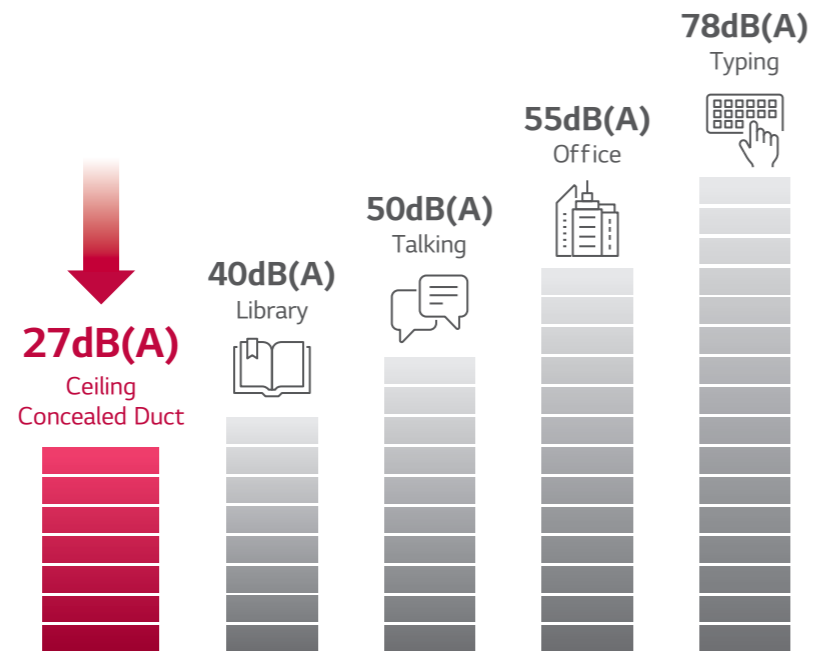

		CL09F N50	CL12F N50	CL18F N60	CL24F N30
Sound Pressure (High / Medium / Low)	dB(A)	35 / 30 / 27	35 / 30 / 27	34 / 31 / 29	39 / 35 / 32

Flexible Installation (Low Static Pressure Model)

Standard Inverter low static duct allows the air intake at the rear or bottom under installation condition.

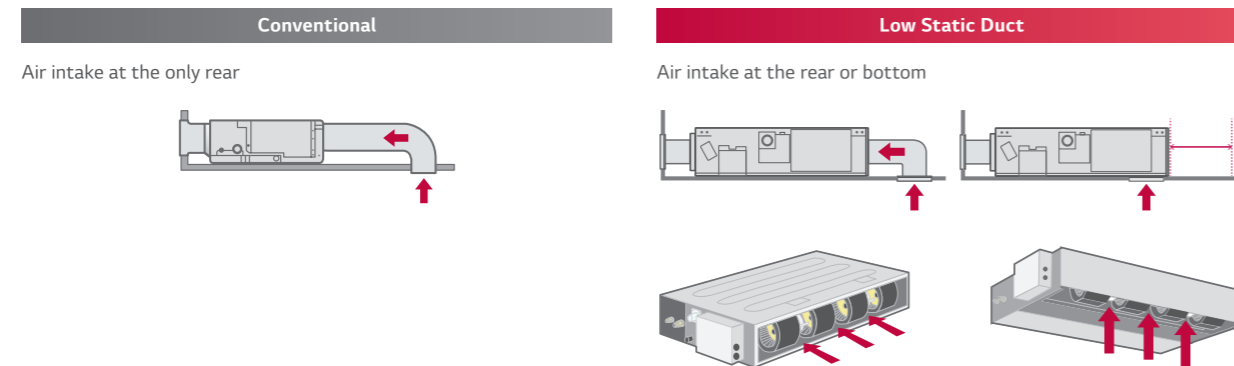

H-INVERTER (R32)

LOW STATIC PRESSURE
- UL12FH / UL18FH

UUA1 ULO UUB1 U20

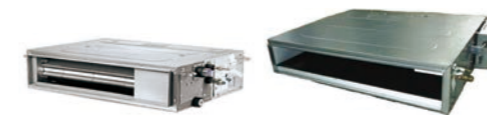

LG participates in the ECP programme for EUROVENT AC program. Check ongoing validity of certification : www.eurovent-certification.com

COMBINATION				12	18
Capacity	Cooling	Min. / Rated / Max.	kW	1.5 / 3.4 / 4.7	2.0 / 5.0 / 6.0
	Heating	Min. / Rated / Max.	kW	1.8 / 4.0 / 4.9	2.3 / 5.8 / 7.0
Power Input (Set)	Cooling	Min. / Rated / Max.	kW	0.33 / 1.05 / 1.84	0.30 / 1.39 / 1.88
	Heating	Min. / Rated / Max.	kW	0.33 / 1.08 / 1.63	0.30 / 1.56 / 2.12
Running Current	Cooling	Rated	A	4.7	7.6
	Heating	Rated	A	4.8	8.1
EER / COP			kWh / kWh	3.23 / 3.71	3.60 / 3.71
SEER / SCOP			kWh / kWh	6.1 / 4.0	6.5 / 4.1
Pdesign	Cooling @ 35°C		kW	3.4	5
	Heating @ -10°C		kW	2.9	4.1
Seasonal Energy Label	Cooling / Heating			A++ / A+	A++ / A+
Annual Energy Consumption	Cooling / Heating		kWh	195 / 1,015	269 / 1,400
Dehumidification Rate			l/h	0.8	2.6
ODU Sound Pressure Level	Cooling / Heating	Rated	dB(A)	49 / 52	47 / 52
	Cooling	Rated	dB(A)	65	63
Piping Connections	Liquid		mm (inch)	Ø6.35 (1/4)	Ø6.35 (1/4)
	Gas		mm (inch)	Ø9.52 (3/8)	Ø12.7 (1/2)
	Connections Method			Flared	Flared
Operation Range (Outdoor)	Cooling	Min. / Max.	°C	-15 / 50	-15 / 50
	Heating	Min. / Max.	°C	-20 / 18	-20 / 18
INDOOR				UL12FH N50	UL18FH N30
Power Supply			Ø / V / Hz	1 / 220-240 / 50	1 / 220-240 / 50
Power Input (IDU)		H / M / L	W	21 / 15 / 13	140 / 125 / 100
Air Flow Rate		H / M / L	m³/min	11.5 / 9.5 / 8	18.5 / 15 / 11
Dimensions	Body	W x H x D	mm	900 x 190 x 460	1,100 x 190 x 700
Weight	Body		kg	18	26.0
Sound Pressure Level	Cooling	H / M / L	dB(A)	35 / 30 / 27	38 / 34 / 31
Sound Power Level	Cooling	Max	dB(A)	55	56
Piping Connections	Drain	O.D. / I.D.	mm	Ø32.0 / 26.0	Ø32.0 / 26.0
OUTDOOR				UUA1 ULO	UUB1 U20
Power Supply			Ø / V / Hz	1 / 220-240 / 50	1 / 220-240 / 50
Circuit Breaker		Min	A	15	20
Power Supply Cable (Included Earth)			No x mm³	3C x 1.5	3C x 2.5
Dimensions	Net	W x H x D	mm	770 x 545 x 288	870 x 650 x 330
Weight	Net		kg	33.3	44.5
Compressor	Type			Twin Rotary	Twin Rotary
	Type			R32	R32
Refrigerant	GWP (Global Warming Potential)			675	675
	Precharged Amount		kg	1.0	1.2
	t-CO ₂ eq			0.675	0.81
	Additional Charge (After 7.5m)		g/m	20	20
Fan	Air Flow Rate	Rated	m³/min x No.	28 x 1	50 x 1
Total Piping Length		Min. / Max.	m	5 / 30	5 / 30
Piping Elevation	IDU - ODU	Max	m	30	30

H-INVERTER (R32)

MID STATIC PRESSURE

- UM12FH / UM18FH / UM24FH / UM30FH

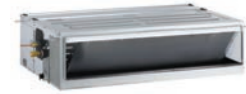

UUA1 ULO

UUB1 U20

UUC1 U40



LG participates in the ECP programme for EUROVENT AC program.
Check ongoing validity of certification
: www.eurovent-certification.com

COMBINATION				12	18	24	30
Capacity	Cooling	Min. / Rated / Max.	kW	1.6 / 3.5 / 5.1	2.0 / 5.0 / 6.0	2.7 / 6.8 / 8.3	3.1 / 7.8 / 9.3
	Heating	Min. / Rated / Max.	kW	1.6 / 4.0 / 5.8	2.3 / 5.8 / 7.0	3.0 / 7.5 / 9.4	3.6 / 9.0 / 10.7
Power Input (Set)	Cooling	Min. / Rated / Max.	kW	0.32 / 1.03 / 1.93	0.30 / 1.26 / 1.70	0.40 / 1.84 / 2.56	0.50 / 2.25 / 2.99
	Heating	Min. / Rated / Max.	kW	0.32 / 0.98 / 1.85	0.30 / 1.49 / 2.01	0.40 / 1.75 / 2.52	0.50 / 2.27 / 3.11
Running Current	Cooling	Rated	A	4.6	7.3	8.2	10.0
	Heating	Rated	A	4.3	7.8	7.8	10.1
EER / COP			kWh / kWh	3.40 / 4.10	3.96 / 3.89	3.70 / 4.28	3.51 / 3.97
SEER / SCOP			kWh / kWh	6.1 / 3.9	6.6 / 4.2	6.8 / 4.3	6.6 / 4.3
Pdesign	Cooling @ 35°C		kW	3.5	5	6.8	7.8
	Heating @ -10°C		kW	2.8	4.4	5.4	5.4
Seasonal Energy Label	Cooling / Heating		-	A++ / A	A++ / A+	A++ / A+	A++ / A+
Annual Energy Consumption	Cooling / Heating		kWh	201 / 1,005	265 / 1,467	350 / 1,758	419 / 1,758
Dehumidification Rate			l/h	0.4	1.3	1.2	2.2
ODU Sound Pressure Level	Cooling / Heating	Rated	dB(A)	49 / 52	47 / 52	48 / 52	50 / 52
ODU Sound Power Level	Cooling	Rated	dB(A)	65	63	65	68
Piping Connections	Liquid		mm (inch)	Ø6.35 (1/4)	Ø6.35 (1/4)	Ø9.52 (3/8)	Ø9.52 (3/8)
	Gas		mm (inch)	Ø9.52 (3/8)	Ø12.7 (1/2)	Ø15.88 (5/8)	Ø15.88 (5/8)
	Connections Method		-	Flared	Flared	Flared	Flared
Operation Range (Outdoor)	Cooling	Min. / Max.	°C	-15 ~ 50	-15 ~ 50	-20 ~ 50	-20 ~ 50
	Heating	Min. / Max.	°C	-20 ~ 18	-20 ~ 18	-20 ~ 18	-20 ~ 18
INDOOR				UM12FH N10	UM18FH N10	UM24FH N20	UM30FH N20
Power Supply			Ø / V / Hz	1 / 220-240 / 50	1 / 220-240 / 50	1 / 220-240 / 50	1 / 220-240 / 50
Power Input (IDU)		H / M / L	W	150 / 130 / 110	180 / 150 / 130	134 / 101 / 80	134 / 101 / 80
Air Flow Rate		H / M / L	m³/min	16.5 / 14.5 / 13	17.5 / 16 / 14	28 / 24 / 21	28 / 24 / 21
Dimensions	Body	W x H x D	mm	900 x 270 x 700	900 x 270 x 700	1,250 x 270 x 700	1,250 x 270 x 700
Weight	Body		kg	25.4	27.0	39.3	39.3
Sound Pressure Level	Cooling	H / M / L	dB(A)	34 / 32 / 30	35 / 34 / 32	34 / 33 / 32	34 / 33 / 32
Sound Power Level	Cooling	Max.	dB(A)	56	60	59	59
Piping Connections	Drain (Natural Drainage)	O.D. / I.D.	mm	Ø25.4 / 19.4	Ø25.4 / 19.4	Ø25.4 / 19.4	Ø25.4 / 19.4
	Drain (Using Drain Pump)	O.D. / I.D.	mm	Ø32.0 / 26.0	Ø32.0 / 26.0	Ø32.0 / 26.0	Ø32.0 / 26.0
OUTDOOR				UUA1 ULO	UUB1 U20	UUC1 U40	
Power Supply			Ø / V / Hz	1 / 220-240 / 50	1 / 220-240 / 50	1 / 220-240 / 50	
Circuit Breaker		Min.	A	15	20	25	
Power Supply Cable (Included Earth)			No x mm³	3C x 1.5	3C x 2.5	3C x 2.5	
Dimensions	Net	W x H x D	mm	770 x 545 x 288	870 x 650 x 330	950 x 834 x 330	
Weight	Net		kg	33.3	44.5	57.7	
Compressor	Type		-	Twin Rotary	Twin Rotary	Twin Rotary	
	Type		-	R32	R32	R32	
Refrigerant	GWP (Global Warming Potential)		-	675	675	675	
	Precharged Amount		kg	1.0	1.2	1.9	
	t-CO ₂ eq		-	0.675	0.81	1.283	
	Additional Charge (After 7.5m)		g/m	20	20	40	
Fan	Air Flow Rate	Rated	m³/min x No.	28 x 1	50 x 1	58 x 1	
Total Piping Length		Min. / Max.	m	5 / 30	5 / 30	5 / 50	
Piping Elevation	IDU - ODU	Max.	m	30	30	30	

H-INVERTER (R32)

MID STATIC PRESSURE

- UM36FH / UM42FH / UM48FH



UUD1 U30



LG participates in the ECP programme for EUROVENT AC program.
Check ongoing validity of certification
: www.eurovent-certification.com

COMBINATION				36	42	48
Capacity	Cooling	Min. / Rated / Max.	kW	3.8 / 9.5 / 12.8	4.8 / 12.0 / 14.4	5.4 / 13.4 / 16.1
	Heating	Min. / Rated / Max.	kW	4.3 / 10.8 / 13.7	5.4 / 13.5 / 16.2	6.2 / 15.5 / 17.8
Power Input (Set)	Cooling	Min. / Rated / Max.	kW	0.50 / 2.26 / 3.39	0.70 / 3.38 / 4.56	0.80 / 4.12 / 5.56
	Heating	Min. / Rated / Max.	kW	0.50 / 2.57 / 3.60	0.70 / 3.51 / 4.56	0.80 / 4.18 / 5.24
Running Current	Cooling	Rated	A	10.0	14.9	18.1
	Heating	Rated	A	11.3	15.3	18.4
EER / COP			kWh / kWh	4.20 / 4.20	3.55 / 3.85	3.25 / 3.71
SEER / SCOP			kWh / kWh	6.4 / 4.2	6.2 / 4.1	6.1 / 4.1
Pdesign	Cooling @ 35°C		kW	9.5	12	13.4
	Heating @ -10°C		kW	9.5	9.5	9.5
Seasonal Energy Label	Cooling / Heating		-	A++ / A+	A++ / A+	-
Annual Energy Consumption	Cooling / Heating		kWh	520 / 3,167	677 / 3,244	1,318 / 3,244
Dehumidification Rate			l/h	2.0	4.2	4.8
ODU Sound Pressure Level	Cooling / Heating	Rated	dB(A)	50 / 50	51 / 52	52 / 53
ODU Sound Power Level	Cooling	Rated	dB(A)	66	69	69
Piping Connections	Liquid		mm (inch)	Ø9.52 (3/8)	Ø9.52 (3/8)	Ø9.52 (3/8)
	Gas		mm (inch)	Ø15.88 (5/8)	Ø15.88 (5/8)	Ø15.88 (5/8)
	Connections Method		-	Flared	Flared	Flared
Operation Range (Outdoor)	Cooling	Min. / Max.	°C	-20 ~ 52	-20 ~ 52	-20 ~ 52
	Heating	Min. / Max.	°C	-25 ~ 18	-25 ~ 18	-25 ~ 18
INDOOR				UM36FH N30	UM42FH N30	UM48FH N30
Power Supply			Ø / V / Hz	1 / 220-240 / 50	1 / 220-240 / 50	1 / 220-240 / 50
Power Input (IDU)		H / M / L	W	242 / 159 / 124	242 / 159 / 124	242 / 159 / 124
Air Flow Rate		H / M / L	m³/min	40 / 34 / 28	40 / 34 / 28	40 / 34 / 28
Dimensions	Body	W x H x D	mm	1,250 x 360 x 700	1,250 x 360 x 700	1,250 x 360 x 700
Weight	Body		kg	44.3	44.3	44.3
Sound Pressure Level	Cooling	H / M / L	dB(A)	39 / 38 / 36	39 / 38 / 36	39 / 38 / 36
Sound Power Level	Cooling	Max.	dB(A)	65	65	65
Piping Connections	Drain (Natural Drainage)	O.D. / I.D.	mm	Ø25.4 / 19.4	Ø25.4 / 19.4	Ø25.4 / 19.4
	Drain (Using Drain Pump)	O.D. / I.D.	mm	Ø32.0 / 26.0	Ø32.0 / 26.0	Ø32.0 / 26.0
OUTDOOR				UUD1 U30		
Power Supply			Ø / V / Hz	1 / 220-240 / 50		
Circuit Breaker		Min.	A	40		
Power Supply Cable (Included Earth)			No x mm³	3C x 6.0		
Dimensions	Net	W x H x D	mm	950 x 1,380 x 330		
Weight	Net		kg	85.0		
Compressor	Type		-	Inverter Scroll		
	Type		-	R32		
Refrigerant	GWP (Global Warming Potential)		-	675		
	Precharged Amount		kg	3.0		
	t-CO ₂ eq		-	2.025		
	Additional Charge (After 7.5m)		g/m	40		
Fan	Air Flow Rate	Rated	m³/min x No.	55 x 2		
Total Piping Length		Min. / Max.	m	5 / 85		
Piping Elevation	IDU - ODU	Max.	m	30		

H-INVERTER (R32)

MID STATIC PRESSURE

- UM36FH / UM42FH / UM48FH

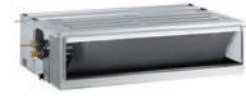

UUD3 U30



LG participates in the ECP programme for EUROVENT AC program.
Check ongoing validity of certification
: www.eurovent-certification.com

COMBINATION				36	42	48
Capacity	Cooling	Min. / Rated / Max.	kW	3.8 - 9.5 - 12.8	4.8 - 12.0 - 14.4	5.4 - 13.4 - 16.1
	Heating	Min. / Rated / Max.	kW	4.3 - 10.8 - 13.7	5.4 - 13.5 - 16.2	6.2 - 15.5 - 17.8
Power Input (Set)	Cooling	Min. / Rated / Max.	kW	0.50 - 2.26 - 3.39	0.70 - 3.38 - 4.56	0.80 - 4.12 - 5.56
	Heating	Min. / Rated / Max.	kW	0.50 - 2.57 - 3.60	0.70 - 3.51 - 4.56	0.80 - 4.18 - 5.24
Running Current	Cooling	Rated	A	3.8	5.3	6.5
	Heating	Rated	A	4.1	5.5	6.5
EER / COP			kWh / kWh	4.20 / 4.20	3.55 / 3.85	3.25 / 3.71
SEER / SCOP			kWh / kWh	6.4 / 4.2	6.2 / 4.1	6.1 / 4.1
Pdesign	Cooling @ 35°C		kW	9.5	12	13.4
	Heating @ -10°C		kW	9.5	9.5	9.5
Seasonal Energy Label	Cooling / Heating		-	A++ / A+	A++ / A+	-
Annual Energy Consumption	Cooling / Heating		kWh	520 / 3,167	677 / 3,244	1,318 / 3,244
Dehumidification Rate			l/h	2.0	4.2	4.8
ODU Sound Pressure Level	Cooling / Heating	Rated	dB(A)	50 / 50	51 / 52	52 / 53
ODU Sound Power Level	Cooling	Rated	dB(A)	66	69	69
Piping Connections	Liquid		mm (inch)	Ø9.52 (3/8)	Ø9.52 (3/8)	Ø9.52 (3/8)
	Gas		mm (inch)	Ø15.88 (5/8)	Ø15.88 (5/8)	Ø15.88 (5/8)
	Connections Method		-	Flared	Flared	Flared
Operation Range (Outdoor)	Cooling	Min. / Max.	°C	-20 / 52	-20 / 52	-20 / 52
	Heating	Min. / Max.	°C	-25 / 18	-25 / 18	-25 / 18
INDOOR				UM36FH N30	UM42FH N30	UM48FH N30
Power Supply			Ø / V / Hz	1 / 220-240 / 50	1 / 220-240 / 50	1 / 220-240 / 50
Power Input (IDU)		H / M / L	W	242 / 159 / 124	242 / 159 / 124	242 / 159 / 124
Air Flow Rate		H / M / L	m³/min	40 / 34 / 28	40 / 34 / 28	40 / 34 / 28
Dimensions	Body	W x H x D	mm	1,250 x 360 x 700	1,250 x 360 x 700	1,250 x 360 x 700
Weight	Body		kg	44.3	44.3	44.3
Sound Pressure Level	Cooling	H / M / L	dB(A)	39 / 38 / 36	39 / 38 / 36	39 / 38 / 36
Sound Power Level	Cooling	Max.	dB(A)	65	65	65
Piping Connections	Drain (Natural Drainage)	O.D. / I.D.	mm	Ø25.4 / 19.4	Ø25.4 / 19.4	Ø25.4 / 19.4
	Drain (Using Drain Pump)	O.D. / I.D.	mm	Ø32.0 / 26.0	Ø32.0 / 26.0	Ø32.0 / 26.0
OUTDOOR				UUD3 U30		
Power Supply			Ø / V / Hz	3 / 380-415 / 50		
Circuit Breaker		Min.	A	20		
Power Supply Cable (Included Earth)			No x mm³	5C x 2.5		
Dimensions	Net	W x H x D	mm	950 x 1,380 x 330		
Weight	Net		kg	85.0		
Compressor	Type		-	Inverter Scroll		
	Type		-	R32		
Refrigerant	GWP (Global Warming Potential)		-	675		
	Precharged Amount		kg	3.0		
	t-CO ₂ eq		-	2.025		
	Additional Charge (After 7.5m)		g/m	40		
Fan	Air Flow Rate	Rated	m³/min x No.	55 x 2		
Total Piping Length		Min. / Max.	m	5 / 85		
Piping Elevation	IDU - ODU	Max.	m	30		

STANDARD INVERTER (R32)

LOW STATIC PRESSURE

- CL09F / CL12F / CL18F / CL24F



UUA1 U10



UUB1 U20



UUC1 U40



LG participates in the ECP programme for EUROVENT AC program.
Check ongoing validity of certification
: www.eurovent-certification.com

COMBINATION				9	12	18	24
Capacity	Cooling	Min. / Rated / Max.	kW	1.5 / 2.5 / 3.2	1.5 / 3.4 / 4.7	2.0 / 5.0 / 5.8	2.7 / 6.8 / 7.8
	Heating	Min. / Rated / Max.	kW	1.8 / 3.2 / 4.0	1.8 / 4.0 / 4.9	2.3 / 5.8 / 6.7	3.0 / 7.5 / 9.0
Power Input (Set)	Cooling	Min. / Rated / Max.	kW	0.30 / 0.67 / 0.93	0.33 / 1.05 / 1.84	0.3 / 1.35 / 1.89	0.4 / 2.03 / 2.84
	Heating	Min. / Rated / Max.	kW	0.38 / 0.75 / 1.63	0.33 / 1.08 / 1.63	0.4 / 1.77 / 2.48	0.4 / 2.13 / 3.30
Running Current	Cooling	Rated	A	3.0	4.7	7.5	9.0
	Heating	Rated	A	3.3	4.8	8.3	9.4
EER / COP			kWh / kWh	3.80 / 4.30	3.23 / 3.71	3.71 / 3.28	3.35 / 3.52
SEER / SCOP			kWh / kWh	6.1 / 4.0	5.6 / 3.8	6.1 / 3.9	6.2 / 3.9
Pdesign	Cooling @ 35°C		kW	2.5	3.4	5	6.8
	Heating @ -10°C		kW	2.9	2.9	4.1	5.4
Seasonal Energy Label	Cooling / Heating		-	A++ / A+	A+ / A	A++ / A	A++ / A
Annual Energy Consumption	Cooling / Heating		kWh	143 / 1,015	213 / 1,068	287 / 1,472	384 / 1,938
Dehumidification Rate			l/h	0.2	0.8	1.6	2.5
ODU Sound Pressure Level	Cooling / Heating	Rated	dB(A)	49 / 52	49 / 52	47 / 52	48 / 52
ODU Sound Power Level	Cooling	Rated	dB(A)	65	65	63	65
Piping Connections	Liquid		mm (inch)	Ø6.35 (1/4)	Ø6.35 (1/4)	Ø6.35 (1/4)	Ø9.52 (3/8)
	Gas		mm (inch)	Ø9.52 (3/8)	Ø9.52 (3/8)	Ø12.7 (1/2)	Ø15.88 (5/8)
	Connections Method		-	Flared	Flared	Flared	Flared
Operation Range (Outdoor)	Cooling	Min. / Max.	°C	-15 / 50	-15 / 50	-15 / 50	-20 / 50
	Heating	Min. / Max.	°C	-20 / 18	-20 / 18	-20 / 18	-20 / 18
INDOOR				CL09F N50	CL12F N50	CL18F N60	CL24F N30
Power Supply			Ø / V / Hz	1 / 220-240 / 50	1 / 220-240 / 50	1 / 220-240 / 50	1 / 220-240 / 50
Power Input (IDU)		H / M / L	W	21 / 15 / 13	21 / 15 / 13	100 / 90 / 80	150 / 130 / 110
Air Flow Rate		H / M / L	m³/min	11.5 / 9.5 / 8	11.5 / 9.5 / 8	15 / 12 / 10	20 / 16 / 12
Dimensions	Body	W x H x D	mm	900 x 190 x 460	900 x 190 x 460	1,100 x 190 x 460	1,100 x 190 x 700
Weight	Body		kg	18.0	18.0	20.9	26.0
Sound Pressure Level	Cooling	H / M / L	dB(A)	35 / 30 / 27	35 / 30 / 27	34 / 31 / 29	39 / 35 / 32
Sound Power Level	Cooling	Max.	dB(A)	55	55	56	58
Piping Connections	Drain	O.D. / I.D.	mm	Ø32.0 / 26.0	Ø32.0 / 26.0	Ø32.0 / 26.0	Ø32.0 / 26.0
OUTDOOR				UUA1 U10			
Power Supply			Ø / V / Hz	1 / 220-240 / 50			
Circuit Breaker		Min.	A	15			
Power Supply Cable (Included Earth)			No x mm³	3C x 1.5			
Dimensions	Net	W x H x D	mm	770 x 545 x 288			
Weight	Net		kg	33.3			
Compressor	Type		-	Twin Rotary			
	Type		-	R32			
Refrigerant	GWP (Global Warming Potential)		-	675			
	Precharged Amount		kg	1.0			
	t-CO ₂ eq		-	0.675			
	Additional Charge (After 7.5m)		g/m	20			
Fan	Air Flow Rate	Rated	m³/min x No.	28 x 1			
Total Piping Length		Min. / Max.	m	5 / 30			
Piping Elevation	IDU - ODU	Max.	m	30			

STANDARD INVERTER (R32)

MID STATIC PRESSURE
- CM18F / CM24F / UM30F

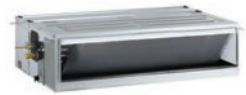

UUB1 U20 UUC1 U40



LG participates in the ECP programme for EUROVENT AC program.
Check ongoing validity of certification
: www.eurovent-certification.com

COMBINATION				18	24	30
Capacity	Cooling	Min. / Rated / Max.	kW	2.0 / 5.0 / 5.8	2.7 / 6.8 / 8.0	3.1 / 7.8 / 9.0
	Heating	Min. / Rated / Max.	kW	2.3 / 5.8 / 6.7	3.0 / 7.5 / 9.0	3.6 / 9.0 / 10.1
Power Input (Set)	Cooling	Min. / Rated / Max.	kW	0.30 / 1.33 / 1.86	0.40 / 1.95 / 2.69	0.40 / 2.23 / 3.03
	Heating	Min. / Rated / Max.	kW	0.40 / 1.76 / 2.46	0.50 / 2.27 / 3.29	0.50 / 2.64 / 3.33
Running Current	Cooling	Rated	A	7.4	8.7	9.9
	Heating	Rated	A	8.3	10.1	11.7
EER / COP			kWh / kWh	3.75 / 3.30	3.49 / 3.31	3.50 / 3.41
SEER / SCOP			kWh / kWh	6.4 / 4.1	6.6 / 3.9	6.1 / 4.0
Pdesign	Cooling @ 35°C		kW	5	6.8	7.8
	Heating @ -10°C		kW	4.1	5.4	5.4
Seasonal Energy Label	Cooling / Heating		-	A++ / A+	A++ / A	A++ / A+
Annual Energy Consumption	Cooling / Heating		kWh	273 / 1,400	361 / 1,938	448 / 1,890
Dehumidification Rate			l/h	1.2	2.6	2.4
ODU Sound Pressure Level	Cooling / Heating	Rated	dB(A)	47 / 52	48 / 52	50 / 52
ODU Sound Power Level	Cooling	Rated	dB(A)	63	65	68
Piping Connections	Liquid		mm (inch)	Ø6.35 (1/4)	Ø9.52 (3/8)	Ø9.52 (3/8)
	Gas		mm (inch)	Ø12.7 (1/2)	Ø15.88 (5/8)	Ø15.88 (5/8)
	Connections Method		-	Flared	Flared	Flared
Operation Range (Outdoor)	Cooling	Min. / Max.	°C	-15 / 50	-20 / 50	-20 / 50
	Heating	Min. / Max.	°C	-20 / 18	-20 / 18	-20 / 18
INDOOR				CM18F N10	CM24F N10	UM30F N10
Power Supply			Ø / V / Hz	1 / 220-240 / 50	1 / 220-240 / 50	1 / 220-240 / 50
Power Input (IDU)		H / M / L	W	150 / 130 / 110	180 / 150 / 130	220 / 200 / 180
Air Flow Rate		H / M / L	m³/min	16.5 / 14.5 / 13	18 / 16.5 / 14.5	22 / 20 / 18
Dimensions	Body	W x H x D	mm	900 x 270 x 700	900 x 270 x 700	900 x 270 x 700
Weight	Body		kg	24.6	24.6	26.2
Sound Pressure Level	Cooling	H / M / L	dB(A)	34 / 32 / 30	35 / 34 / 32	37 / 35 / 34
Sound Power Level	Cooling	Max.	dB(A)	59	60	62
Piping Connections	Drain (Natural Drainage)	O.D. / I.D.	mm	Ø25.4 / 19.4	Ø25.4 / 19.4	Ø25.4 / 19.4
	Drain (Using Drain Pump)	O.D. / I.D.	mm	Ø32.0 / 26.0	Ø32.0 / 26.0	Ø32.0 / 26.0
OUTDOOR				UUB1 U20	UUC1 U40	
Power Supply			Ø / V / Hz	1 / 220-240 / 50	1 / 220-240 / 50	
Circuit Breaker		Min.	A	20	25	
Power Supply Cable (Included Earth)			No x mm³	3C x 2.5	3C x 2.5	
Dimensions	Net	W x H x D	mm	870 x 650 x 330	950 x 834 x 330	
Weight	Net		kg	44.5	57.7	
Compressor	Type		-	Twin Rotary	Twin Rotary	
	Type		-	R32	R32	
Refrigerant	GWP (Global Warming Potential)		-	675	675	
	Precharged Amount		kg	1.2	1.9	
	t-CO ₂ eq		-	0.81	1.283	
	Additional Charge (After 7.5m)		g/m	20	40	
Fan	Air Flow Rate	Rated	m³/min x No.	50 x 1	58 x 1	
Total Piping Length		Min. / Max.	m	5 / 30	5 / 50	
Piping Elevation	IDU - ODU	Max.	m	30	30	

STANDARD INVERTER (R32)

MID STATIC PRESSURE
- UM36F / UM42F / UM48F / UM60F

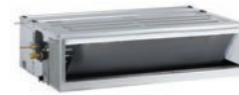

UUD1 U30



LG participates in the ECP programme for EUROVENT AC program.
Check ongoing validity of certification
: www.eurovent-certification.com

COMBINATION				36	42	48	60
Capacity	Cooling	Min. / Rated / Max.	kW	3.8 / 9.5 / 12.5	4.8 / 12.0 / 14.0	5.4 / 13.4 / 15.7	5.8 / 14.6 / 15.8
	Heating	Min. / Rated / Max.	kW	4.3 / 10.8 / 13.4	5.4 / 13.5 / 15.8	6.2 / 15.5 / 17.5	6.7 / 16.8 / 18.1
Power Input (Set)	Cooling	Min. / Rated / Max.	kW	0.50 / 2.50 / 3.80	0.70 / 3.48 / 4.52	0.90 / 4.32 / 5.62	1.00 / 4.95 / 5.54
	Heating	Min. / Rated / Max.	kW	0.60 / 2.77 / 3.77	0.80 / 3.74 / 4.86	0.90 / 4.31 / 5.26	0.90 / 4.60 / 5.29
Running Current	Cooling	Rated	A	11.1	15.3	19.0	21.6
	Heating	Rated	A	12.6	16.4	18.4	20.4
EER / COP			kWh / kWh	3.80 / 3.90	3.45 / 3.61	3.10 / 3.60	2.95 / 3.65
SEER / SCOP			kWh / kWh	5.80 / 3.90	5.60 / 3.90	5.80 / 4.00	5.60 / 4.00
Pdesign	Cooling @ 35°C		kW	9.5	12.0	13.4	14.6
	Heating @ -10°C		kW	9.5	9.5	9.5	9.5
Seasonal Energy Label	Cooling / Heating		-	A+ / A	A+ / A	- / -	- / -
Annual Energy Consumption	Cooling / Heating		kWh	573 / 3,410	750 / 3,410	1,386 / 3,325	1,564 / 3,325
Dehumidification Rate			l/h	2.9	4.4	4.8	4.7
ODU Sound Pressure Level	Cooling / Heating	Rated	dB(A)	50 / 50	51 / 52	52 / 53	54 / 54
ODU Sound Power Level	Cooling	Rated	dB(A)	66	69	69	71
Piping Connections	Liquid		mm (inch)	Ø9.52 (3/8)	Ø9.52 (3/8)	Ø9.52 (3/8)	Ø9.52 (3/8)
	Gas		mm (inch)	Ø15.88 (5/8)	Ø15.88 (5/8)	Ø15.88 (5/8)	Ø15.88 (5/8)
	Connections Method		-	Flared	Flared	Flared	Flared
Operation Range (Outdoor)	Cooling	Min. / Max.	°C	-20 / 52	-20 / 52	-20 / 52	-20 / 52
	Heating	Min. / Max.	°C	-25 / 18	-25 / 18	-25 / 18	-25 / 18
INDOOR				UM36F N20	UM42F N20	UM48F N30	UM60F N30
Power Supply			Ø / V / Hz	1 / 220-240 / 50	1 / 220-240 / 50	1 / 220-240 / 50	1 / 220-240 / 50
Power Input (IDU)		H / M / L	W	183 / 134 / 101	266 / 200 / 145	242 / 159 / 124	342 / 287 / 242
Air Flow Rate		H / M / L	m³/min	32 / 28 / 24	38 / 33 / 28	40 / 34 / 28	50 / 45 / 40
Dimensions	Body	W x H x D	mm	1,250 x 270 x 700	1,250 x 270 x 700	1,250 x 360 x 700	1,250 x 360 x 700
Weight	Body		kg	38.5	38.5	43.5	43.5
Sound Pressure Level	Cooling	H / M / L	dB(A)	36 / 34 / 33	38 / 36 / 34	39 / 38 / 36	42 / 40 / 39
Sound Power Level	Cooling	Max.	dB(A)	60	62	65	66
Piping Connections	Drain (Natural Drainage)	O.D. / I.D.	mm	Ø25.4 / 19.4	Ø25.4 / 19.4	Ø25.4 / 19.4	Ø25.4 / 19.4
	Drain (Using Drain Pump)	O.D. / I.D.	mm	Ø32.0 / 26.0	Ø32.0 / 26.0	Ø32.0 / 26.0	Ø32.0 / 26.0
OUTDOOR				UUD1 U30			
Power Supply			Ø / V / Hz	1 / 220-240 / 50			
Circuit Breaker		Min.	A	40			
Power Supply Cable (Included Earth)			No x mm³	3C x 6.0			
Dimensions	Net	W x H x D	mm	950 x 1,380 x 330			
Weight	Net		kg	85			
Compressor	Type		-	Inverter Scroll			
	Type		-	R32			
Refrigerant	GWP (Global Warming Potential)		-	675			
	Precharged Amount		kg	3.0			
	t-CO ₂ eq		-	2.025			
	Additional Charge (After 7.5m)		g/m	40			
Fan	Air Flow Rate	Rated	m³/min x No.	55 x 2			
Total Piping Length		Min. / Max.	m	5 / 85			
Piping Elevation	IDU - ODU	Max.	m	30			

STANDARD INVERTER (R32)

MID STATIC PRESSURE

- UM 36F / UM42F / UM48F / UM60F

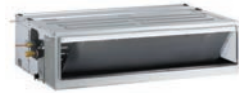

UUD3 U30



LG participates in the ECP programme for EUROVENT AC program. Check ongoing validity of certification : www.eurovent-certification.com

COMBINATION				36	42	48	60
Capacity	Cooling	Min. / Rated / Max.	kW	3.8 / 9.5 / 12.5	4.8 / 12.0 / 14.0	5.4 / 13.4 / 15.7	5.8 / 14.6 / 15.8
	Heating	Min. / Rated / Max.	kW	4.3 / 10.8 / 13.4	5.4 / 13.5 / 15.8	6.2 / 15.5 / 17.5	6.7 / 16.8 / 18.1
Power Input (Set)	Cooling	Min. / Rated / Max.	kW	0.50 / 2.50 / 3.80	0.70 / 3.48 / 4.52	0.90 / 4.32 / 5.62	1.00 / 4.95 / 5.54
	Heating	Min. / Rated / Max.	kW	0.60 / 2.77 / 3.77	0.80 / 3.74 / 4.86	0.90 / 4.31 / 5.26	0.90 / 4.60 / 5.29
Running Current	Cooling	Rated	A	4.0	5.5	6.8	7.7
	Heating	Rated	A	4.5	5.9	6.5	7.2
EER / COP			kWh / kWh	3.80 / 3.90	3.45 / 3.61	3.10 / 3.60	2.95 / 3.65
SEER / SCOP			kWh / kWh	5.8 / 3.9	5.6 / 3.9	5.8 / 4.0	5.6 / 4.0
Pdesign	Cooling @ 35°C		kW	9.5	12	13.4	14.6
	Heating @ -10°C		kW	9.5	9.5	9.5	9.5
Seasonal Energy Label	Cooling / Heating		-	A+ / A	A+ / A	- / -	- / -
Annual Energy Consumption	Cooling / Heating		kWh	573 / 3,410	750 / 3,410	1,386 / 3,325	1,564 / 3,325
Dehumidification Rate			l/h	2.9	4.4	4.8	4.7
ODU Sound Pressure Level	Cooling / Heating	Rated	dB(A)	50 / 50	51 / 52	52 / 53	54 / 54
ODU Sound Power Level	Cooling	Rated	dB(A)	66	69	69	71
Piping Connections	Liquid		mm (inch)	Ø9.52 (3/8)	Ø9.52 (3/8)	Ø9.52 (3/8)	Ø9.52 (3/8)
	Gas		mm (inch)	Ø15.88 (5/8)	Ø15.88 (5/8)	Ø15.88 (5/8)	Ø15.88 (5/8)
	Connections Method		-	Flared	Flared	Flared	Flared
Operation Range (Outdoor)	Cooling	Min. / Max.	°C	-20 / 52	-20 / 52	-20 / 52	-20 / 52
	Heating	Min. / Max.	°C	-25 / 18	-25 / 18	-25 / 18	-25 / 18
INDOOR				UM36F N20	UM42F N20	UM48F N30	UM60F N30
Power Supply			Ø / V / Hz	1 / 220-240 / 50	1 / 220-240 / 50	1 / 220-240 / 50	1 / 220-240 / 50
Power Input (IDU)		H / M / L	W	183 / 134 / 101	266 / 200 / 145	242 / 159 / 124	342 / 287 / 242
Air Flow Rate		H / M / L	m³/min	32 / 28 / 24	38 / 33 / 28	40 / 34 / 28	50 / 45 / 40
Dimensions	Body	W x H x D	mm	1,250 x 270 x 700	1,250 x 270 x 700	1,250 x 360 x 700	1,250 x 360 x 700
Weight	Body		kg	38.5	38.5	43.5	43.5
Sound Pressure Level	Cooling	H / M / L	dB(A)	36 / 34 / 33	38 / 36 / 34	39 / 38 / 36	42 / 40 / 39
Sound Power Level	Cooling	Max.	dB(A)	60	62	65	66
Piping Connections	Drain (Natural Drainage)	O.D. / I.D.	mm	Ø25.4 / 19.4	Ø25.4 / 19.4	Ø25.4 / 19.4	Ø25.4 / 19.4
	Drain (Using Drain Pump)	O.D. / I.D.	mm	Ø32.0 / 26.0	Ø32.0 / 26.0	Ø32.0 / 26.0	Ø32.0 / 26.0
OUTDOOR				UUD3 U30			
Power Supply			Ø / V / Hz	3 / 380-415 / 50			
Circuit Breaker		Min.	A	20			
Power Supply Cable (Included Earth)			No x mm³	5C x 2.5			
Dimensions	Net	W x H x D	mm	950 x 1,380 x 330			
Weight	Net		kg	85			
Compressor	Type		-	Inverter Scroll			
	Type		-	R32			
Refrigerant	GWP (Global Warming Potential)		-	675			
	Precharged Amount		kg	3.0			
	t-CO ₂ eq		-	2.025			
	Additional Charge (After 7.5m)		g/m	40			
Fan	Air Flow Rate	Rated	m³/min x No.	55 x 2			
Total Piping Length		Min. / Max.	m	5 / 85			
Piping Elevation	IDU - ODU	Max.	m	30			

COMPACT INVERTER (R32)

LOW STATIC PRESSURE

- CL18F / CL24F

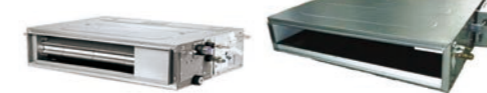

UUA1 ULO

UUB1 U20



LG participates in the ECP programme for EUROVENT AC program. Check ongoing validity of certification : www.eurovent-certification.com

COMBINATION				18	24
Capacity	Cooling	Min. / Rated / Max.	kW	1.8 / 4.7 / 5.1	2.7 / 6.8 / 7.5
	Heating	Min. / Rated / Max.	kW	2.1 / 5.2 / 5.7	3.0 / 7.5 / 8.6
Power Input (Set)	Cooling	Min. / Rated / Max.	kW	0.34 / 1.62 / 1.99	0.40 / 2.12 / 2.54
	Heating	Min. / Rated / Max.	kW	0.30 / 1.53 / 1.99	0.50 / 2.41 / 3.13
Running Current	Cooling	Rated	A	7.2	9.3
	Heating	Rated	A	6.8	10.5
EER / COP			kWh / kWh	2.90 / 3.40	3.21 / 3.11
SEER / SCOP			kWh / kWh	5.1 / 3.8	6.0 / 4.1
Pdesign	Cooling @ 35°C		kW	4.7	6.8
	Heating @ -10°C		kW	2.7	4.2
Seasonal Energy Label	Cooling / Heating		-	A / A	A+ / A+
Annual Energy Consumption	Cooling / Heating		kWh	323 / 995	397 / 1,434
Dehumidification Rate			l/h	1.5	2.4
ODU Sound Pressure Level	Cooling / Heating	Rated	dB(A)	49 / 52	48 / 53
ODU Sound Power Level	Cooling	Rated	dB(A)	65	65
Piping Connections	Liquid		mm (inch)	Ø6.35 (1/4)	Ø9.52 (3/8)
	Gas		mm (inch)	Ø12.7 (1/2)	Ø15.88 (5/8)
	Connections Method		-	Flared	Flared
Operation Range (Outdoor)	Cooling	Min. / Max.	°C	-10 / 50	-10 / 48
	Heating	Min. / Max.	°C	-10 / 18	-15 / 18
INDOOR				CL18F N60	CL24F N30
Power Supply			Ø / V / Hz	1 / 220-240 / 50	1 / 220-240 / 50
Power Input (IDU)		H / M / L	W	100 / 90 / 80	150 / 130 / 110
Air Flow Rate		H / M / L	m³/min	15 / 12 / 10	20 / 16 / 12
Dimensions	Body	W x H x D	mm	1,100 x 190 x 460	1,100 x 190 x 700
Weight	Body		kg	20.9	26
Sound Pressure Level	Cooling	H / M / L	dB(A)	34 / 31 / 29	39 / 35 / 32
Sound Power Level	Cooling	Max.	dB(A)	56	58
Piping Connections	Drain	O.D. / I.D.	mm	Ø32.0 / 26.0	Ø32.0 / 26.0
OUTDOOR				UUA1 ULO	UUB1 U20
Power Supply			Ø / V / Hz	1 / 220-240 / 50	1 / 220-240 / 50
Circuit Breaker		Min.	A	15	20
Power Supply Cable (Included Earth)			No x mm³	3C x 1.5	3C x 2.5
Dimensions	Net	W x H x D	mm	770 x 545 x 288	870 x 650 x 330
Weight	Net		kg	33.3	44.5
Compressor	Type		-	Twin Rotary	
	Type		-	R32	
Refrigerant	GWP (Global Warming Potential)		-	675	
	Precharged Amount		kg	1.0	
	t-CO ₂ eq		-	0.675	
	Additional Charge (After 7.5m)		g/m	20	
Fan	Air Flow Rate	Rated	m³/min x No.	28 x 1	50 x 1
Total Piping Length		Min. / Max.	m	5 / 30	5 / 35
Piping Elevation	IDU - ODU	Max.	m	30	30

COMPACT INVERTER (R32)

MID STATIC PRESSURE
- CM18F / CM24F / UM30F / UM36F

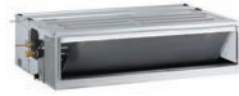

UUA1 ULO UUB1 U20 UUC1 U40



LG participates in the ECP programme for EUROVENT AC program.
Check ongoing validity of certification
: www.eurovent-certification.com

COMBINATION				18	24	30	36
Capacity	Cooling	Min. / Rated / Max.	kW	1.8 / 5.0 / 5.6	2.7 / 6.8 / 7.5	3.0 / 7.5 / 8.3	3.8 / 9.5 / 10.5
	Heating	Min. / Rated / Max.	kW	2.2 / 5.5 / 6.7	3.0 / 7.4 / 8.5	3.2 / 8.0 / 8.8	4.3 / 10.8 / 11.5
Power Input (Set)	Cooling	Min. / Rated / Max.	kW	0.35 / 1.67 / 1.92	0.50 / 2.34 / 2.81	0.50 / 2.57 / 3.08	0.60 / 3.16 / 3.86
	Heating	Min. / Rated / Max.	kW	0.32 / 1.58 / 1.77	0.40 / 2.17 / 2.82	0.50 / 2.25 / 2.93	0.60 / 3.03 / 3.48
Running Current	Cooling	Rated	A	7.4	10.3	11.0	14.0
	Heating	Rated	A	7.0	9.7	9.7	13.4
EER / COP			kWh / kWh	3.00 / 3.50	2.91 / 3.41	2.92 / 3.56	3.01 / 3.57
SEER / SCOP			kWh / kWh	6.1 / 3.8	5.8 / 4.1	5.6 / 3.9	5.9 / 4.0
Pdesign	Cooling @ 35°C		kW	5	6.8	7.5	9.5
	Heating @ -10°C		kW	2.8	4.1	4.3	5.5
Seasonal Energy Label	Cooling / Heating		-	A++ / A	A+ / A+	A+ / A	A+ / A+
Annual Energy Consumption	Cooling / Heating		kWh	287 / 1,032	410 / 1,400	469 / 1,544	564 / 1,924
Dehumidification Rate			l/h	1.2	2.5	2.6	3.2
ODU Sound Pressure Level	Cooling / Heating	Rated	dB(A)	49 / 52	48 / 53	50 / 54	54 / 56
ODU Sound Power Level	Cooling	Rated	dB(A)	65	65	67	70
Piping Connections	Liquid		mm (inch)	Ø6.35 (1/4)	Ø9.52 (3/8)	Ø9.52 (3/8)	Ø9.52 (3/8)
	Gas		mm (inch)	Ø12.7 (1/2)	Ø15.88 (5/8)	Ø15.88 (5/8)	Ø15.88 (5/8)
	Connections Method		-	Flared	Flared	Flared	Flared
Operation Range (Outdoor)	Cooling	Min. / Max.	°C	-10 / 50	-10 / 48	-10 / 48	-20 / 50
	Heating	Min. / Max.	°C	-10 / 18	-15 / 18	-15 / 18	-15 / 18
INDOOR				CM18F N10	CM24F N10	UM30F N10	UM36F N20
Power Supply			Ø / V / Hz	1 / 220-240 / 50	1 / 220-240 / 50	1 / 220-240 / 50	1 / 220-240 / 50
Power Input (IDU)		H / M / L	W	150 / 130 / 110	180 / 150 / 130	220 / 200 / 180	183 / 134 / 101
Air Flow Rate		H / M / L	m³/min	16.5 / 14.5 / 13	18 / 16.5 / 14.5	22 / 20 / 18	32 / 28 / 24
Dimensions	Body	W x H x D	mm	900 x 270 x 700	900 x 270 x 700	900 x 270 x 700	1,250 x 270 x 700
Weight	Body		kg	24.6	24.6	26.2	38.5
Sound Pressure Level	Cooling	H / M / L	dB(A)	34 / 32 / 30	35 / 34 / 32	37 / 35 / 34	36 / 34 / 33
Sound Power Level	Cooling	Max.	dB(A)	59	60	62	60
Piping Connections	Drain (Natural Drainage)	O.D. / I.D.	mm	Ø25.4 / 19.4	Ø25.4 / 19.4	Ø25.4 / 19.4	Ø25.4 / 19.4
	Drain (Using Drain Pump)	O.D. / I.D.	mm	Ø32.0 / 26.0	Ø32.0 / 26.0	Ø32.0 / 26.0	Ø32.0 / 26.0
OUTDOOR				UUA1 ULO	UUB1 U20	UUC1 U40	
Power Supply			Ø / V / Hz	1 / 220-240 / 50	1 / 220-240 / 50	1 / 220-240 / 50	
Circuit Breaker		Min.	A	15	20	25	
Power Supply Cable (Included Earth)			No x mm²	3C x 1.5	3C x 2.5	3C x 2.5	
Dimensions	Net	W x H x D	mm	770 x 545 x 288	870 x 650 x 330	950 x 834 x 330	
Weight	Net		kg	33.3	44.5	57.7	
Compressor	Type		-	Twin Rotary	Twin Rotary	Twin Rotary	
	Type		-	R32	R32	R32	
Refrigerant	GWP (Global Warming Potential)		-	675	675	675	
	Precharged Amount		kg	1	1.2	1.9	
	t-CO ₂ eq		-	0.675	0.81	1.283	
	Additional Charge (After 7.5m)		g/m	20	40	40	
Fan	Air Flow Rate	Rated	m³/min x No.	28 x 1	50 x 1	58 x 1	
Total Piping Length		Min. / Max.	m	5 / 30	5 / 35	5 / 50	
Piping Elevation	IDU - ODU	Max.	m	30	30	30	

STANDARD INVERTER (R410A)

HIGH STATIC PRESSURE
- UB70 / UB85



UU70W UU85W



LG participates in the ECP programme for EUROVENT AC program.
Check ongoing validity of certification
: www.eurovent-certification.com

INDOOR				UB70 N94	UB85 N94
Capacity	Cooling	Min. / Nom. / Max.	kW	7.6 / 19.0 / 20.9	9.2 / 23.0 / 25.3
	Heating	Min. / Nom. / Max.	kW	9.0 / 22.4 / 24.6	10.8 / 27.0 / 29.7
Low Temperature Capacity	Heating -7°C	Max.	kW	18.0	24.0
Power Input (Set)	Cooling	Nom.	kW	6.69	8.19
	Heating	Nom.	kW	6.4	8.31
Power Input (Indoor)		Min. / Max. (Nom ESP)	W	550 / 760	610 / 920
Running Current	Cooling / Heating	Nom.	A	11.5 / 10.7	13.5 / 13.6
Power Supply			Ø / V / Hz	1 / 220-240 / 50	1 / 220-240 / 50
EER				2.84	2.81
COP				3.50	3.25
SEER				4.90	4.80
SCOP				3.53	3.51
Pdesign (@ -10°C)			kW	13.4	18.5
Seasonal Energy Label	Cooling / Heating		-	-	-
Annual Energy Consumption	Cooling / Heating		kWh	-	-
Piping Connection	Liquid		mm (inch)	Ø9.52 (3/8)	Ø12.7 (1/2)
	Gas		mm (inch)	Ø25.4 (1/1)	Ø22.2 (7/8)
	Drain	O.D. / I.D.	mm	32 / 25	32 / 25
Air Flow Rate		High / Medium / Low	m³/min	70.0 / 65.0 / 60.0	80.0 / 72.0 / 64.0
Sound Pressure	Cooling	High / Medium / Low	dB(A)	43 / 41 / 40	43 / 41 / 40
Sound Power	Cooling	Max.	dB(A)	73	75
Dehumidification Rate			l/h	1.81 (4.2)	5.14 (11.9)
Dimensions	Body	W x H x D	mm	1,563 x 460 x 688	1,563 x 460 x 688
Net Weight	Body		kg	90.0	90.0
External Static Pressure		Min. / Max.	mmAq(Pa)	6 / 25 (60 / 250)	6 / 25 (60 / 250)
OUTDOOR				UU70W U34	UU85W U74
Compressor	Type			Hermetically Sealed Scroll	Hermetically Sealed Scroll
Airflow Rate		Nom.	m³/min	110	190
Sound Pressure	Cooling	Nom.	dB(A)	55	59
	Heating	Nom.	dB(A)	58	60
Sound Power	Cooling	Max.	dB(A)	75	75
Dimensions	W x H x D		mm	950 x 1,380 x 330	1,090 x 1,625 x 380
Net Weight			kg	110	144.0
Refrigerant	Type		-	R410A	R410A
	Charge		g	5,200	5,500
	Additional Charge		g/m	70	70
	GWP		-	2087.5	2087.5
Operation Range (Outdoor)	TCO ₂ eq		-	10.9	11.5
	Cooling	Min. / Max.	°C DB	-20 / 48	-20 / 48
Power Supply	Heating	Min. / Max.	°C WB	-18 / 18	-18 / 18
			Ø / V / Hz	3 / 380-415 / 50	3 / 380-415 / 50
Power Supply Cable			No. x mm²	5C x 2.5	5C x 2.5
Transmission Cable			No. x mm²	4C x 1.0	4C x 1.0
Circuit Breaker			A	30	30
Piping Length Total		Min. / Max.	m	5 / 75	5 / 75
Piping Elevation Difference	IDU - ODU	Max.	m	30	30
Piping Connection	Liquid		mm (inch)	Ø9.53 (3/8)	Ø12.7 (1.2)
	Gas		mm (inch)	Ø25.4 (1/1)	Ø22.2 (7/8)

Note :

- Due to our policy of innovation some specifications may be changed without notification.
- Performances are based on the following conditions (It is accordance with EN14511)
 - Cooling : Indoor Ambient Temp 27°C DB / 19°C WB, Outdoor Ambient Temp 35°C DB / 24°C WB
 - Heating : Indoor Ambient Temp 20°C DB / 15°C WB, Outdoor Ambient Temp 7°C DB / 6°C WB
 - Interconnected Pipe is standard length and difference of Elevation (Outdoor - Indoor Unit) is 0m.
- Sound Level Values are measured at Noise Measuring chamber accordance with standard. Therefore, these values depend on the ambient conditions and values are normally higher in actual operation.
- This product contains fluorinated greenhouse gases. (R410A)

CEILING SUSPENDED



Differentiated Design

Modern elegant design with V-shape and black vane is appropriate for any commercial space. It received iF Design Award.



Powerful Cooling & Heating

High ceiling mode provides powerful cooling and heating up to 4.2m in height from floor, 15m away from ceiling.



Airflow path and improved heat exchanger's performance.

Outlet Space

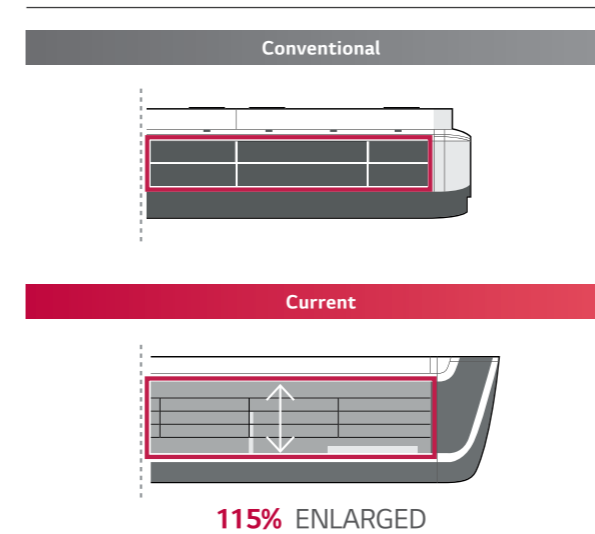

Optimized the Airflow Path

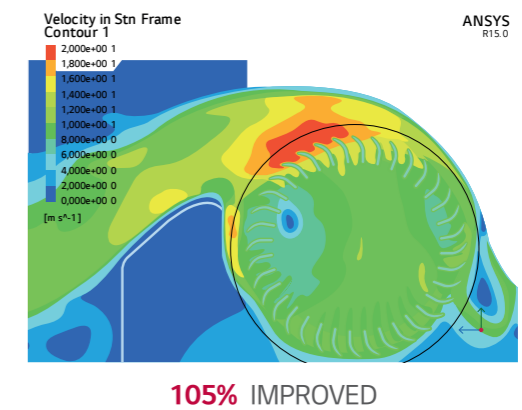

One Touch & 2 Piece Filter

Easy in / out filter structure as well as a simplified two-piece filter, which slides out for easy cleaning and maintenance.

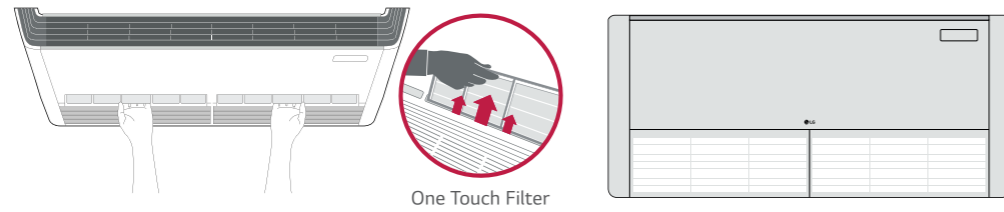

Two Thermistors Control

Users can purchase a wired remote controller that includes a second thermistor, allowing for temperature checks from multiple locations.



Installation

Installation speed and ease is improved by reducing the total number of screws used and placing the screws on the easily accessible front panel.

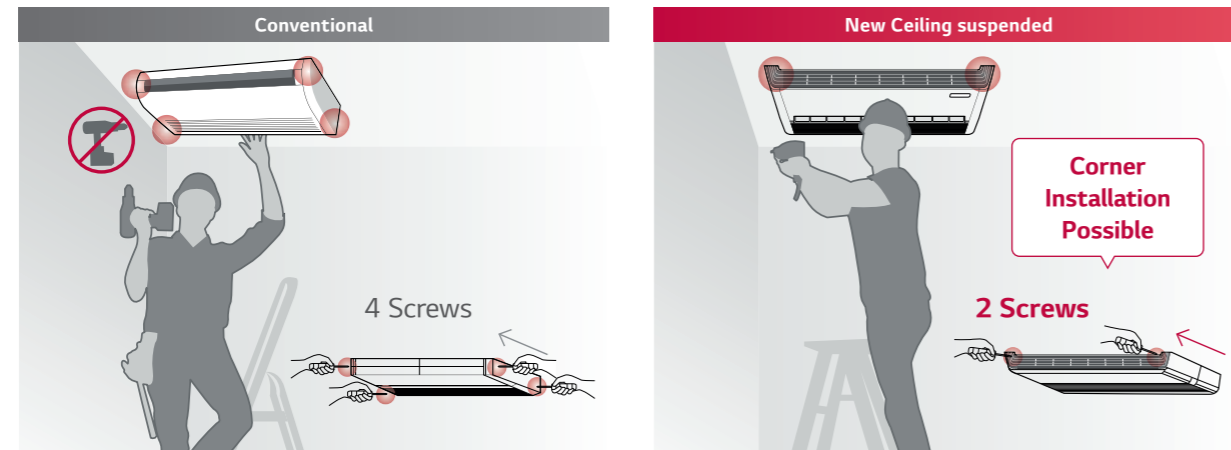

H-INVERTER (R32)

UV18FH / UV24FH / UV30FH

UUB1 U20 UUC1 U40



LG participates in the ECP programme for EUROVENT AC program. Check ongoing validity of certification : www.eurovent-certification.com

COMBINATION				18	24	30
Capacity	Cooling	Min. / Rated / Max.	kW	2.0 / 5.0 / 6.0	2.7 / 6.8 / 8.3	3.2 / 8.0 / 9.5
	Heating	Min. / Rated / Max.	kW	2.3 / 5.8 / 7.0	3.0 / 7.5 / 9.4	3.6 / 8.9 / 10.6
Power Input (Set)	Cooling	Min. / Rated / Max.	kW	0.30 / 1.28 / 1.73	0.40 / 1.80 / 2.50	0.50 / 2.35 / 3.13
	Heating	Min. / Rated / Max.	kW	0.30 / 1.56 / 2.13	0.40 / 1.82 / 2.62	0.50 / 2.39 / 3.27
Running Current	Cooling	Rated	A	7.3	8	10.4
	Heating	Rated	A	8	8.1	10.6
EER / COP			kWh / kWh	3.90 / 3.71	3.77 / 4.11	3.41 / 3.72
SEER / SCOP			kWh / kWh	7.6 / 4.4	7.9 / 4.6	7.2 / 4.6
Pdesign	Cooling @ 35°C		kW	5	6.8	8
	Heating @ -10°C		kW	4.3	5.4	5.4
Seasonal Energy Label	Cooling / Heating			A++ / A+	A++ / A++	A++ / A++
Annual Energy Consumption	Cooling / Heating		kWh	230 / 1,368	301 / 1,644	389 / 1,644
Dehumidification Rate			l/h	1.9	2.0	2.8
ODU Sound Pressure Level	Cooling / Heating	Rated	dB(A)	47 / 52	48 / 52	50 / 52
ODU Sound Power Level	Cooling	Rated	dB(A)	63	65	68
Piping Connections	Liquid		mm (inch)	Ø6.35 (1/4)	Ø9.52 (3/8)	Ø9.52 (3/8)
	Gas		mm (inch)	Ø12.7 (1/2)	Ø15.88 (5/8)	Ø15.88 (5/8)
Connections Method				Flared	Flared	Flared
Operation Range (Outdoor)	Cooling	Min. / Max.	°C	-15 / 50	-20 / 50	-20 / 50
	Heating	Min. / Max.	°C	-20 / 18	-20 / 18	-20 / 18
INDOOR				UV18FH N10	UV24FH N20	UV30FH N20
Power Supply			Ø / V / Hz	1 / 220-240 / 50	1 / 220-240 / 50	1 / 220-240 / 50
Power Input (IDU)		H / M / L	W	17 / 15 / 13	35 / 32 / 27	35 / 32 / 27
Air Flow Rate		H / M / L	m³/min	12.5 / 11 / 10	23 / 21 / 19	23 / 21 / 19
Dimensions	Body	W x H x D	mm	1,200 x 235 x 690	1,600 x 235 x 690	1,600 x 235 x 690
	Body		kg	28.7	37.4	37.4
Sound Pressure Level	Cooling	H / M / L	dB (A)	41 / 39 / 38	43 / 42 / 40	43 / 42 / 40
Sound Power Level	Cooling	Max.	dB (A)	55	60	60
Piping Connections	Drain (Natural Drainage)	O.D. / I.D.	mm	Ø25.0 / 20.5	Ø25.0 / 20.5	Ø25.0 / 20.5
	Drain (Using Drain Pump)	O.D. / I.D.	mm	Ø32.0 / 26.0	Ø32.0 / 26.0	Ø32.0 / 26.0
OUTDOOR				UUB1 U20	UUC1 U40	
Power Supply			Ø / V / Hz	1 / 220-240 / 50	1 / 220-240 / 50	
Circuit Breaker		Min.	A	20	25	
Power Supply Cable (Included Earth)			No x mm³	3C x 2.5	3C x 2.5	
Dimensions	Net	W x H x D	mm	870 x 650 x 330	950 x 834 x 330	
Weight	Net		kg	44.5	57.7	
Compressor	Type			Twin Rotary	Twin Rotary	
	Type			R32	R32	
Refrigerant	GWP (Global Warming Potential)			675	675	
	Precharged Amount		kg	1.2	1.9	
	t-CO ₂ eq			0.81	1.283	
	Additional Charge (After 7.5m)		g/m	20	40	
Fan	Air Flow Rate	Rated	m³/min x No.	50 x 1	58 x 1	
Total Piping Length		Min. / Max.	m	5 / 30	5 / 50	
Piping Elevation	IDU - ODU	Max.	m	30	30	

Note :

- Due to our policy of innovation some specifications may be changed without notification.
- Performances are based on the following conditions (It is accordance with EN14511)
 - Cooling : Indoor Ambient Temp 27°C DB / 19°C WB, Outdoor Ambient Temp 35°C DB / 24°C WB
 - Heating : Indoor Ambient Temp 20°C DB / 15°C WB, Outdoor Ambient Temp 7°C DB / 6°C WB
 - Interconnected Pipe is standard length and difference of Elevation (Outdoor - Indoor Unit) is 0m.
- Sound Level Values are measured at Noise Measuring chamber accordance with standard. Therefore, these values depend on the ambient conditions and values are normally higher in actual operation.
- This product contains fluorinated greenhouse gases. (R32)

H-INVERTER (R32)

UV36FH / UV42FH



LG participates in the ECP programme for EUROVENT AC program.
Check ongoing validity of certification
: www.eurovent-certification.com

UUD1 U30



COMBINATION				36	42
Capacity	Cooling	Min. / Rated / Max.	kW	3.8 / 9.5 / 12.8	4.8 / 12.1 / 14.5
	Heating	Min. / Rated / Max.	kW	4.3 / 10.8 / 13.7	5.4 / 13.5 / 16.2
Power Input (Set)	Cooling	Min. / Rated / Max.	kW	0.5 / 2.50 / 3.75	0.7 / 3.64 / 4.91
	Heating	Min. / Rated / Max.	kW	0.5 / 2.54 / 3.56	0.8 / 3.75 / 4.88
Running Current	Cooling	Rated	A	11.1	16
	Heating	Rated	A	11.4	16.5
EER / COP			kWh / kWh	3.80 / 4.25	3.32 / 3.60
SEER / SCOP			kWh / kWh	6.70 / 4.30	6.60 / 4.30
Pdesign	Cooling @ 35°C		kW	9.5	12.1
	Heating @ -10°C		kW	9.5	9.5
Seasonal Energy Label	Cooling / Heating		-	A++ / A+	- / -
Annual Energy Consumption	Cooling / Heating		kWh	496 / 3,093	1,100 / 3,093
Dehumidification Rate			l/h	3.6	5.52
ODU Sound Pressure Level	Cooling / Heating	Rated	dB(A)	50 / 50	51 / 52
ODU Sound Power Level	Cooling	Rated	dB(A)	66	69
Piping Connections	Liquid		mm (inch)	Ø9.52 (3/8)	Ø9.52 (3/8)
	Gas		mm (inch)	Ø15.88 (5/8)	Ø15.88 (5/8)
Connections Method			-	Flared	Flared
Operation Range (Outdoor)	Cooling	Min. / Max.	°C	-20 / 52	-20 / 52
	Heating	Min. / Max.	°C	-25 / 18	-25 / 18
INDOOR				UV36FH N20	UV42FH N20
Power Supply			Ø / V / Hz	1 / 220-240 / 50	1 / 220-240 / 50
Power Input (IDU)		H / M / L	W	59 / 40 / 28	59 / 40 / 28
Air Flow Rate		H / M / L	m³/min	30 / 25 / 20	30 / 25 / 20
Dimensions	Body	W x H x D	mm	1,600 x 235 x 690	1,600 x 235 x 690
	Body		kg	37.4	37.4
Sound Pressure Level	Cooling	H / M / L	dB (A)	48 / 44 / 40	48 / 44 / 40
Sound Power Level	Cooling	Max.	dB (A)	62	62
Piping Connections	Drain (Natural Drainage)	O.D. / I.D.	mm	Ø25.0 / 20.5	Ø25.0 / 20.5
	Drain (Using Drain Pump)	O.D. / I.D.	mm	Ø32.0 / 26.0	Ø32.0 / 26.0
OUTDOOR				UUD1 U30	
Power Supply			Ø / V / Hz	1 / 220-240 / 50	
Circuit Breaker		Min.	A	40	
Power Supply Cable (Included Earth)			No x mm³	3C x 6.0	
Dimensions	Net	W x H x D	mm	950 x 1,380 x 330	
Weight	Net		kg	85	
Compressor	Type		-	Inverter Scroll	
	Type		-	R32	
Refrigerant	GWP (Global Warming Potential)		-	675	
	Precharged Amount		kg	3.0	
	t-CO ₂ eq		-	2.025	
	Additional Charge (After 7.5m)		g/m	40	
Fan	Air Flow Rate	Rated	m³/min x No.	55 x 2	
Total Piping Length		Min. / Max.	m	5 / 85	
Piping Elevation	IDU - ODU	Max.	m	30	

Note :

- Due to our policy of innovation some specifications may be changed without notification.
- Performances are based on the following conditions (It is accordance with EN14511)
 - Cooling : Indoor Ambient Temp 27°C DB / 19°C WB, Outdoor Ambient Temp 35°C DB / 24°C WB
 - Heating : Indoor Ambient Temp 20°C DB / 15°C WB, Outdoor Ambient Temp 7°C DB / 6°C WB
 - Interconnected Pipe is standard length and difference of Elevation (Outdoor - Indoor Unit) is 0m.
- Sound Level Values are measured at Noise Measuring chamber accordance with standard. Therefore, these values depend on the ambient conditions and values are normally higher in actual operation.
- This product contains fluorinated greenhouse gases. (R32)

H-INVERTER (R32)

UV36FH / UV42FH



LG participates in the ECP programme for EUROVENT AC program.
Check ongoing validity of certification
: www.eurovent-certification.com

UUD3 U30



COMBINATION				36	42
Capacity	Cooling	Min. / Rated / Max.	kW	3.8 / 9.5 / 12.8	4.8 / 12.1 / 14.5
	Heating	Min. / Rated / Max.	kW	4.3 / 10.8 / 13.7	5.4 / 13.5 / 16.2
Power Input (Set)	Cooling	Min. / Rated / Max.	kW	0.50 / 2.50 / 3.75	0.70 / 3.64 / 4.91
	Heating	Min. / Rated / Max.	kW	0.50 / 2.54 / 3.56	0.80 / 3.75 / 4.88
Running Current	Cooling	Rated	A	4.0	5.7
	Heating	Rated	A	4.1	5.9
EER / COP			kWh / kWh	3.80 / 4.25	3.32 / 3.60
SEER / SCOP			kWh / kWh	6.7 / 4.3	6.6 / 4.3
Pdesign	Cooling @ 35°C		kW	9.5	12.1
	Heating @ -10°C		kW	9.5	9.5
Seasonal Energy Label	Cooling / Heating		-	A++ / A+	- / -
Annual Energy Consumption	Cooling / Heating		kWh	496 / 3,093	1,100 / 3,093
Dehumidification Rate			l/h	3.6	5.5
ODU Sound Pressure Level	Cooling / Heating	Rated	dB(A)	50 / 50	51 / 52
ODU Sound Power Level	Cooling	Rated	dB(A)	66	69
Piping Connections	Liquid		mm (inch)	Ø9.52 (3/8)	Ø9.52 (3/8)
	Gas		mm (inch)	Ø15.88 (5/8)	Ø15.88 (5/8)
Connections Method			-	Flared	Flared
Operation Range (Outdoor)	Cooling	Min. / Max.	°C	-20 / 52	-20 / 52
	Heating	Min. / Max.	°C	-25 / 18	-25 / 18
INDOOR				UV36FH N20	UV42FH N20
Power Supply			Ø / V / Hz	1 / 220-240 / 50	1 / 220-240 / 50
Power Input (IDU)		H / M / L	W	59 / 40 / 28	59 / 40 / 28
Air Flow Rate		H / M / L	m³/min	30 / 25 / 20	30 / 25 / 20
Dimensions	Body	W x H x D	mm	1,600 x 235 x 690	1,600 x 235 x 690
	Body		kg	37.4	37.4
Sound Pressure Level	Cooling	H / M / L	dB (A)	48 / 44 / 40	48 / 44 / 40
Sound Power Level	Cooling	Max.	dB (A)	62	62
Piping Connections	Drain (Natural Drainage)	O.D. / I.D.	mm	Ø25.0 / 20.5	Ø25.0 / 20.5
	Drain (Using Drain Pump)	O.D. / I.D.	mm	Ø32.0 / 26.0	Ø32.0 / 26.0
OUTDOOR				UUD3 U30	
Power Supply			Ø / V / Hz	3 / 380-415 / 50	
Circuit Breaker		Min.	A	20	
Power Supply Cable (Included Earth)			No x mm³	5C x 2.5	
Dimensions	Net	W x H x D	mm	950 x 1,380 x 330	
Weight	Net		kg	85	
Compressor	Type		-	Inverter Scroll	
	Type		-	R32	
Refrigerant	GWP (Global Warming Potential)		-	675	
	Precharged Amount		kg	3.0	
	t-CO ₂ eq		-	2.025	
	Additional Charge (After 7.5m)		g/m	40	
Fan	Air Flow Rate	Rated	m³/min x No.	55 x 2	
Total Piping Length		Min. / Max.	m	5 / 85	
Piping Elevation	IDU - ODU	Max.	m	30	

Note :

- Due to our policy of innovation some specifications may be changed without notification.
- Performances are based on the following conditions (It is accordance with EN14511)
 - Cooling : Indoor Ambient Temp 27°C DB / 19°C WB, Outdoor Ambient Temp 35°C DB / 24°C WB
 - Heating : Indoor Ambient Temp 20°C DB / 15°C WB, Outdoor Ambient Temp 7°C DB / 6°C WB
 - Interconnected Pipe is standard length and difference of Elevation (Outdoor - Indoor Unit) is 0m.
- Sound Level Values are measured at Noise Measuring chamber accordance with standard. Therefore, these values depend on the ambient conditions and values are normally higher in actual operation.
- This product contains fluorinated greenhouse gases (R32)

STANDARD INVERTER (R32)

UV18F / UV24F / UV30F



LG participates in the ECP programme for EUROVENT AC program. Check ongoing validity of certification : www.eurovent-certification.com

UUB1 U20 UUC1 U40



COMBINATION				18	24	30
Capacity	Cooling	Min. / Rated / Max.	kW	2.0 / 5.0 / 5.8	2.7 / 6.7 / 8.0	3.1 / 7.7 / 8.8
	Heating	Min. / Rated / Max.	kW	2.3 / 5.8 / 6.7	3.0 / 7.5 / 9.0	3.4 / 8.6 / 9.6
Power Input (Set)	Cooling	Min. / Rated / Max.	kW	0.30 / 1.33 / 1.86	0.40 / 1.99 / 2.69	0.50 / 2.25 / 3.08
	Heating	Min. / Rated / Max.	kW	0.40 / 1.76 / 2.46	0.40 / 2.2 / 3.08	0.50 / 2.5 / 3.20
Running Current	Cooling	Rated	A	7.5	8.8	10.0
	Heating	Rated	A	8.3	9.8	11.1
EER / COP			kWh / kWh	3.75 / 3.29	3.37 / 3.41	3.42 / 3.44
SEER / SCOP			kWh / kWh	6.6 / 4.3	7.2 / 4.2	6.8 / 4.4
Pdesign	Cooling @ 35°C		kW	5	6.7	7.7
	Heating @ -10°C		kW	4.2	4.9	5.4
Seasonal Energy Label	Cooling / Heating		-	A++ / A+	A++ / A+	A++ / A+
Annual Energy Consumption	Cooling / Heating		kWh	265 / 1,368	326 / 1,633	396 / 1,718
Dehumidification Rate			l/h	1.8	2.7	3.0
ODU Sound Pressure Level	Cooling / Heating	Rated	dB(A)	47 / 52	48 / 52	50 / 52
ODU Sound Power Level	Cooling	Rated	dB(A)	63	65	68
Piping Connections	Liquid		mm (inch)	Ø6.35 (1/4)	Ø9.52 (3/8)	Ø9.52 (3/8)
	Gas		mm (inch)	Ø12.7 (1/2)	Ø15.88 (5/8)	Ø15.88 (5/8)
Connections Method			-	Flared	Flared	Flared
Operation Range (Outdoor)	Cooling	Min. / Max.	°C	-15 / 50	-20 / 50	-20 / 50
	Heating	Min. / Max.	°C	-20 / 18	-20 / 18	-20 / 18
INDOOR				UV18F N10	UV24F N10	UV30F N10
Power Supply			Ø / V / Hz	1 / 220-240 / 50	1 / 220-240 / 50	1 / 220-240 / 50
Power Input (IDU)		H / M / L	W	17 / 15 / 13	33 / 26 / 19	47 / 40 / 33
Air Flow Rate		H / M / L	m³/min	13 / 12 / 11	16 / 15 / 14	19 / 17.5 / 16
Dimensions	Body	W x H x D	mm	1,200 x 235 x 690	1,200 x 235 x 690	1,200 x 235 x 690
	Weight		kg	27.3	28	28
Sound Pressure Level	Cooling	H / M / L	dB (A)	42 / 40 / 39	46 / 45 / 43	46 / 44 / 43
Sound Power Level	Cooling	Max	dB (A)	55	61	62
Piping Connections	Drain (Natural Drainage)	O.D. / I.D.	mm	Ø25.0 / 20.5	Ø25.0 / 20.5	Ø25.0 / 20.5
	Drain (Using Drain Pump)	O.D. / I.D.	mm	Ø32.0 / 26.0	Ø32.0 / 26.0	Ø32.0 / 26.0
OUTDOOR				UUB1 U20	UUC1 U40	
Power Supply			Ø / V / Hz	1 / 220-240 / 50	1 / 220-240 / 50	
Circuit Breaker		Min	A	20	25	
Power Supply Cable (Included Earth)			No x mm³	3C x 2.5	3C x 2.5	
Dimensions	Net	W x H x D	mm	870 x 650 x 330	950 x 834 x 330	
	Weight	Net	kg	44.5	57.7	
Compressor	Type		-	Twin Rotary	Twin Rotary	
	Type		-	R32	R32	
Refrigerant	GWP (Global Warming Potential)		-	675	675	
	Precharged Amount		kg	1.2	1.9	
	t-CO ₂ eq		-	0.81	1.283	
	Additional Charge (After 7.5m)		g/m	20	40	
Fan	Air Flow Rate	Rated	m³/min x No.	50 x 1	58 x 1	
Total Piping Length		Min. / Max.	m	5 / 30	5 / 50	
Piping Elevation	IDU - ODU	Max	m	30	30	

Note :

- Due to our policy of innovation some specifications may be changed without notification.
- Performances are based on the following conditions (It is accordance with EN14511)
 - Cooling : Indoor Ambient Temp 27°C DB / 19°C WB, Outdoor Ambient Temp 35°C DB / 24°C WB
 - Heating : Indoor Ambient Temp 20°C DB / 15°C WB, Outdoor Ambient Temp 7°C DB / 6°C WB
 - Interconnected Pipe is standard length and difference of Elevation (Outdoor - Indoor Unit) is 0m.
- Sound Level Values are measured at Noise Measuring chamber accordance with standard. Therefore, these values depend on the ambient conditions and values are normally higher in actual operation
- This product contains fluorinated greenhouse gases (R32)

STANDARD INVERTER (R32)

UV36F / UV42F / UV48F / UV60F



LG participates in the ECP programme for EUROVENT AC program. Check ongoing validity of certification : www.eurovent-certification.com

UUD1 U30



COMBINATION				36	42	48	60
Capacity	Cooling	Min. / Rated / Max.	kW	3.8 / 9.5 / 12.5	4.8 / 12.1 / 14.2	5.4 / 13.4 / 15.7	5.8 / 14.4 / 15.6
	Heating	Min. / Rated / Max.	kW	4.3 / 10.8 / 13.4	5.4 / 13.5 / 15.8	6.2 / 15.5 / 17.5	6.7 / 16.8 / 18.1
Power Input (Set)	Cooling	Min. / Rated / Max.	kW	0.50 / 2.65 / 4.03	0.80 / 3.90 / 5.07	0.90 / 4.50 / 5.85	1.10 / 5.33 / 5.97
	Heating	Min. / Rated / Max.	kW	0.50 / 2.60 / 3.54	0.80 / 3.75 / 4.88	0.90 / 4.77 / 5.82	1.10 / 5.60 / 6.44
Running Current	Cooling	Rated	A	11.7	17.0	19.7	23.6
	Heating	Rated	A	11.4	16.5	20.6	24.6
EER / COP			kWh / kWh	3.59 / 4.15	3.10 / 3.60	2.98 / 3.25	2.70 / 3.00
SEER / SCOP			kWh / kWh	6.3 / 4.1	6.3 / 4.1	5.9 / 4.1	5.7 / 4.1
Pdesign	Cooling @ 35°C		kW	9.5	12.1	13.4	14.4
	Heating @ -10°C		kW	9.5	9.5	9.5	9.5
Seasonal Energy Label	Cooling / Heating		-	A++ / A+	- / -	- / -	- / -
Annual Energy Consumption	Cooling / Heating		kWh	528 / 3,244	1,152 / 3,244	1,363 / 3,244	1,516 / 3,244
Dehumidification Rate			l/h	3.6	5.5	6.3	7.1
ODU Sound Pressure Level	Cooling / Heating	Rated	dB(A)	50 / 50	51 / 52	52 / 53	54 / 54
ODU Sound Power Level	Cooling	Rated	dB(A)	66	69	69	71
Piping Connections	Liquid		mm (inch)	Ø9.52 (3/8)	Ø9.52 (3/8)	Ø9.52 (3/8)	Ø9.52 (3/8)
	Gas		mm (inch)	Ø15.88 (5/8)	Ø15.88 (5/8)	Ø15.88 (5/8)	Ø15.88 (5/8)
Connections Method			-	Flared	Flared	Flared	Flared
Operation Range (Outdoor)	Cooling	Min. / Max.	°C	-20 / 52	-20 / 52	-20 / 52	-20 / 52
	Heating	Min. / Max.	°C	-25 / 18	-25 / 18	-25 / 18	-25 / 18
INDOOR				UV36F N20	UV42F N20	UV48F N20	UV60F N20
Power Supply			Ø / V / Hz	1 / 220-240 / 50	1 / 220-240 / 50	1 / 220-240 / 50	1 / 220-240 / 50
Power Input (IDU)		H / M / L	W	50 / 35 / 28	50 / 35 / 28	59 / 40 / 28	59 / 40 / 28
Air Flow Rate		H / M / L	m³/min	28 / 24 / 20	28 / 24 / 20	30 / 25 / 20	30 / 25 / 20
Dimensions	Body	W x H x D	mm	1,600 x 235 x 690	1,600 x 235 x 690	1,600 x 235 x 690	1,600 x 235 x 690
	Weight		kg	36.7	36.7	36.7	36.7
Sound Pressure Level	Cooling	H / M / L	dB (A)	46 / 43 / 40	46 / 43 / 40	48 / 44 / 40	48 / 44 / 40
Sound Power Level	Cooling	Max	dB (A)	62	62	63	63
Piping Connections	Drain (Natural Drainage)	O.D. / I.D.	mm	Ø25.0 / 20.5	Ø25.0 / 20.5	Ø25.0 / 20.5	Ø25.0 / 20.5
	Drain (Using Drain Pump)	O.D. / I.D.	mm	Ø32.0 / 26.0	Ø32.0 / 26.0	Ø32.0 / 26.0	Ø32.0 / 26.0
OUTDOOR				UUD1 U30			
Power Supply			Ø / V / Hz	1 / 220-240 / 50			
Circuit Breaker		Min	A	40			
Power Supply Cable (Included Earth)			No x mm³	3C x 6.0			
Dimensions	Net	W x H x D	mm	950 x 1,380 x 330			
	Weight	Net	kg	85			
Compressor	Type		-	Inverter Scroll			
	Type		-	R32			
Refrigerant	GWP (Global Warming Potential)		-	675			
	Precharged Amount		kg	3.0			
	t-CO ₂ eq		-	2.025			
	Additional Charge (After 7.5m)		g/m	40			
Fan	Air Flow Rate	Rated	m³/min x No.	55 x 2			
Total Piping Length		Min. / Max.	m	5 / 85			
Piping Elevation	IDU - ODU	Max	m	30			

Note :

- Due to our policy of innovation some specifications may be changed without notification.
- Performances are based on the following conditions (It is accordance with EN14511)
 - Cooling : Indoor Ambient Temp 27°C DB / 19°C WB, Outdoor Ambient Temp 35°C DB / 24°C WB
 - Heating : Indoor Ambient Temp 20°C DB / 15°C WB, Outdoor Ambient Temp 7°C DB / 6°C WB
 - Interconnected Pipe is standard length and difference of Elevation (Outdoor - Indoor Unit) is 0m.
- Sound Level Values are measured at Noise Measuring chamber accordance with standard. Therefore, these values depend on the ambient conditions and values are normally higher in actual operation
- This product contains fluorinated greenhouse gases (R32)

STANDARD INVERTER (R32)

UV36F / UV42F / UV48F / UV60F



LG participates in the ECP programme for EUROVENT AC program. Check ongoing validity of certification : www.eurovent-certification.com

UUD3 U30



COMBINATION				36	42	48	60
Capacity	Cooling	Min. / Rated / Max.	kW	38 / 9.5 / 12.5	48 / 12.1 / 14.2	5.4 / 13.4 / 15.7	5.8 / 14.4 / 15.6
	Heating	Min. / Rated / Max.	kW	4.3 / 10.8 / 13.4	5.4 / 13.5 / 15.8	6.2 / 15.5 / 17.5	6.7 / 16.8 / 18.1
Power Input (Set)	Cooling	Min. / Rated / Max.	kW	0.50 / 2.65 / 4.03	0.80 / 3.90 / 5.07	0.90 / 4.50 / 5.85	1.10 / 5.33 / 5.97
	Heating	Min. / Rated / Max.	kW	0.50 / 2.60 / 3.54	0.80 / 3.75 / 4.88	0.90 / 4.77 / 5.82	1.10 / 5.60 / 6.44
Running Current	Cooling	Rated	A	4.2	6.1	7.0	8.2
	Heating	Rated	A	4.1	5.9	7.3	8.5
EER / COP			kWh / kWh	3.59 / 4.15	3.10 / 3.60	2.98 / 3.25	2.70 / 3.00
SEER / SCOP			kWh / kWh	6.3 / 4.1	6.3 / 4.1	5.9 / 4.1	5.7 / 4.1
Pdesign	Cooling @ 35°C		kW	9.5	12.1	13.4	14.4
	Heating @ -10°C		kW	9.5	9.5	9.5	9.5
Seasonal Energy Label	Cooling / Heating		-	A++ / A+	- / -	- / -	- / -
Annual Energy Consumption	Cooling / Heating		kWh	528 / 3,244	1,152 / 3,244	1,363 / 3,244	1,516 / 3,244
Dehumidification Rate			l/h	3.6	5.5	6.3	7.1
ODU Sound Pressure Level	Cooling / Heating	Rated	dB(A)	50 / 50	51 / 52	52 / 53	54 / 54
ODU Sound Power Level	Cooling	Rated	dB(A)	66	69	69	71
Piping Connections	Liquid		mm (inch)	Ø9.52 (3/8)	Ø9.52 (3/8)	Ø9.52 (3/8)	Ø9.52 (3/8)
	Gas		mm (inch)	Ø15.88 (5/8)	Ø15.88 (5/8)	Ø15.88 (5/8)	Ø15.88 (5/8)
Connections Method			-	Flared	Flared	Flared	Flared
Operation Range (Outdoor)	Cooling	Min. / Max.	°C	-20 / 52	-20 / 52	-20 / 52	-20 / 52
	Heating	Min. / Max.	°C	-25 / 18	-25 / 18	-25 / 18	-25 / 18
INDOOR				UV36F N20	UV42F N20	UV48F N20	UV60F N20
Power Supply			Ø / V / Hz	1 / 220-240 / 50	1 / 220-240 / 50	1 / 220-240 / 50	1 / 220-240 / 50
Power Input (IDU)		H / M / L	W	50 / 35 / 28	50 / 35 / 28	59 / 40 / 28	59 / 40 / 28
Air Flow Rate		H / M / L	m³/min	28 / 24 / 20	28 / 24 / 20	30 / 25 / 20	30 / 25 / 20
Dimensions	Body	W x H x D	mm	1,600 x 235 x 690	1,600 x 235 x 690	1,600 x 235 x 690	1,600 x 235 x 690
Weight	Body		kg	36.7	36.7	36.7	36.7
Sound Pressure Level	Cooling	H / M / L	dB (A)	46 / 43 / 40	46 / 43 / 40	48 / 44 / 40	48 / 44 / 40
Sound Power Level	Cooling	Max.	dB (A)	62	62	63	63
Piping Connections	Drain (Natural Drainage)	O.D. / I.D.	mm	Ø25.0 / 20.5	Ø25.0 / 20.5	Ø25.0 / 20.5	Ø25.0 / 20.5
	Drain (Using Drain Pump)	O.D. / I.D.	mm	Ø32.0 / 26.0	Ø32.0 / 26.0	Ø32.0 / 26.0	Ø32.0 / 26.0
OUTDOOR				UUD3 U30			
Power Supply			Ø / V / Hz	3 / 380-415 / 50			
Circuit Breaker		Min.	A	20			
Power Supply Cable (Included Earth)			No x mm³	5C x 2.5			
Dimensions	Net	W x H x D	mm	950 x 1,380 x 330			
Weight	Net		kg	85			
Compressor	Type		-	Inverter Scroll			
	Type		-	R32			
Refrigerant	GWP (Global Warming Potential)		-	675			
	Precharged Amount		kg	3.0			
	t-CO ₂ eq		-	2.025			
	Additional Charge (After 7.5m)		g/m	40			
Fan	Air Flow Rate	Rated	m³/min x No.	55 x 2			
Total Piping Length		Min. / Max.	m	5 / 85			
Piping Elevation	IDU - ODU	Max.	m	30			

Note :

- Due to our policy of innovation some specifications may be changed without notification.
- Performances are based on the following conditions (It is accordance with EN14511)
 - Cooling : Indoor Ambient Temp 27°C DB / 19°C WB, Outdoor Ambient Temp 35°C DB / 24°C WB
 - Heating : Indoor Ambient Temp 20°C DB / 15°C WB, Outdoor Ambient Temp 7°C DB / 6°C WB
 - Interconnected Pipe is standard length and difference of Elevation (Outdoor - Indoor Unit) is 0m.
- Sound Level Values are measured at Noise Measuring chamber accordance with standard. Therefore, these values depend on the ambient conditions and values are normally higher in actual operation
- This product contains fluorinated greenhouse gases (R32)

COMPACT INVERTER (R32)

UV18F / UV24F / UV30F / UV36F



LG participates in the ECP programme for EUROVENT AC program. Check ongoing validity of certification : www.eurovent-certification.com

UUA1 ULO

UUB1 U20

UUC1 U40



COMBINATION				18	24	30	36
Capacity	Cooling	Min. / Rated / Max.	kW	1.8 / 5.0 / 5.5	2.7 / 6.8 / 7.5	3.0 / 7.5 / 8.3	3.8 / 9.5 / 10.5
	Heating	Min. / Rated / Max.	kW	2.2 / 5.3 / 5.8	2.9 / 7.3 / 8.4	3.2 / 8.0 / 8.8	4.1 / 10.3 / 11.5
Power Input (Set)	Cooling	Min. / Rated / Max.	kW	0.32 / 1.62 / 1.93	0.40 / 2.06 / 2.47	0.50 / 2.42 / 2.90	0.70 / 3.28 / 3.87
	Heating	Min. / Rated / Max.	kW	0.30 / 1.44 / 1.86	0.40 / 2.23 / 2.90	0.50 / 2.48 / 3.22	0.60 / 2.78 / 3.45
Running Current	Cooling	Rated	A	7.2	9.0	10.6	14.6
	Heating	Rated	A	6.4	9.7	10.8	12.3
EER / COP			kWh / kWh	3.10 / 3.70	3.30 / 3.28	3.10 / 3.23	2.90 / 3.70
SEER / SCOP			kWh / kWh	6.6 / 4.6	6.6 / 4.2	6.6 / 4.3	6.1 / 4.2
Pdesign	Cooling @ 35°C		kW	5	6.8	7.5	9.5
	Heating @ -10°C		kW	2.9	4.3	4.4	5.5
Seasonal Energy Label	Cooling / Heating		-	A++ / A++	A++ / A+	A++ / A+	A++ / A+
Annual Energy Consumption	Cooling / Heating		kWh	265 / 883	361 / 1,433	398 / 1,433	545 / 1,833
Dehumidification Rate			l/h	1.7	2.4	2.8	3.6
ODU Sound Pressure Level	Cooling / Heating	Rated	dB(A)	49 / 52	48 / 53	50 / 54	54 / 56
ODU Sound Power Level	Cooling	Rated	dB(A)	65	65	67	70
Piping Connections	Liquid		mm (inch)	Ø6.35 (1/4)	Ø9.52 (3/8)	Ø9.52 (3/8)	Ø9.52 (3/8)
	Gas		mm (inch)	Ø12.7 (1/2)	Ø15.88 (5/8)	Ø15.88 (5/8)	Ø15.88 (5/8)
Connections Method			-	Flared	Flared	Flared	Flared
Operation Range (Outdoor)	Cooling	Min. / Max.	°C	-10 / 50	-10 / 48	-10 / 48	-20 / 50
	Heating	Min. / Max.	°C	-10 / 18	-15 / 18	-15 / 18	-15 / 18
INDOOR				UV18F N10	UV24F N10	UV30F N10	UV36F N20
Power Supply			Ø / V / Hz	1 / 220-240 / 50	1 / 220-240 / 50	1 / 220-240 / 50	1 / 220-240 / 50
Power Input (IDU)		H / M / L	W	17 / 15 / 13	33 / 26 / 19	47 / 40 / 33	50 / 35 / 28
Air Flow Rate		H / M / L	m³/min	13 / 12 / 11	16 / 15 / 14	19 / 17.5 / 16	28 / 24 / 20
Dimensions	Body	W x H x D	mm	1,200 x 235 x 690	1,200 x 235 x 690	1,200 x 235 x 690	1,600 x 235 x 690
Weight	Body		kg	27.3	28	28	36.7
Sound Pressure Level	Cooling	H / M / L	dB (A)	42 / 40 / 39	46 / 45 / 43	46 / 44 / 43	46 / 43 / 40
Sound Power Level	Cooling	Max.	dB (A)	55	61	62	62
Piping Connections	Drain (Natural Drainage)	O.D. / I.D.	mm	Ø25.0 / 20.5	Ø25.0 / 20.5	Ø25.0 / 20.5	Ø25.0 / 20.5
	Drain (Using Drain Pump)	O.D. / I.D.	mm	Ø32.0 / 26.0	Ø32.0 / 26.0	Ø32.0 / 26.0	Ø32.0 / 26.0
OUTDOOR				UUA1 ULO	UUB1 U20	UUC1 U40	
Power Supply			Ø / V / Hz	1 / 220-240 / 50	1 / 220-240 / 50	1 / 220-240 / 50	
Circuit Breaker		Min.	A	15	20	25	
Power Supply Cable (Included Earth)			No x mm³	3C x 1.5	3C x 2.5	3C x 2.5	
Dimensions	Net	W x H x D	mm	770 x 545 x 288	870 x 650 x 330	950 x 834 x 330	
Weight	Net		kg	33.3	44.5	57.7	
Compressor	Type		-	Twin Rotary	Twin Rotary	Twin Rotary	
	Type		-	R32	R32	R32	
Refrigerant	GWP (Global Warming Potential)		-	675	675	675	
	Precharged Amount		kg	1.0	1.2	1.9	
	t-CO ₂ eq		-	0.675	0.81	1.283	
	Additional Charge (After 7.5m)		g/m	20	40	40	
Fan	Air Flow Rate	Rated	m³/min x No.	28 x 1	50 x 1	58 x 1	
Total Piping Length		Min. / Max.	m	5 / 30	5 / 35	5 / 50	
Piping Elevation	IDU - ODU	Max.	m	30	30	30	

Note :

- Due to our policy of innovation some specifications may be changed without notification.
- Performances are based on the following conditions (It is accordance with EN14511)
 - Cooling : Indoor Ambient Temp 27°C DB / 19°C WB, Outdoor Ambient Temp 35°C DB / 24°C WB
 - Heating : Indoor Ambient Temp 20°C DB / 15°C WB, Outdoor Ambient Temp 7°C DB / 6°C WB
 - Interconnected Pipe is standard length and difference of Elevation (Outdoor - Indoor Unit) is 0m.
- Sound Level Values are measured at Noise Measuring chamber accordance with standard. Therefore, these values depend on the ambient conditions and values are normally higher in actual operation.
- This product contains fluorinated greenhouse gases. (R32)

CONSOLE



Optimized Air Flow for Cooling & Heating

During cooling operation, the vane adjusts upwards to direct air flow toward the ceiling. During heating operation, the van directs the air flow toward the floor to balance out the room temperature. A wireless controller is included with the indoor console unit.

Cooling

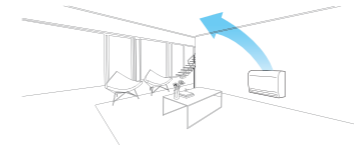

Heating (Normal)

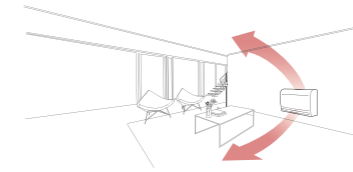

Heating (Floor Heating Mode)

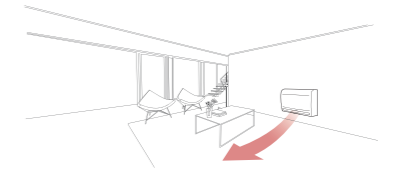

Quick Floor Heating

Console air conditioners portray high speed and powerful performance. Using the floor heating mode, console air conditioners provide floor heating at a faster pace in order to reach desired temperature more quickly.

	Company A	Electric Heater	LG	LG Floor Heating Mode
27°C				
15°C				
Lead Time for Heating (13°C - 21°C)	12 minutes 30 seconds	50 minutes	9 minutes 30 seconds	8 minutes 40 seconds

※ Test Condition : Target Temp 23°C, Indoor Room : 13°C-, Outdoor Room : 7°C

5-Step Vane Control

There are 5 different stages to control air flow direction.

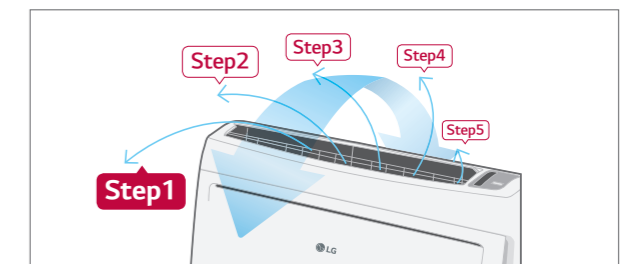

Easy Installation and Service

6 Different Ways to Install Piping

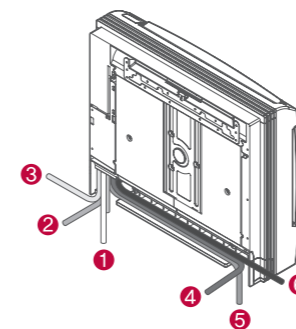

Easy Slide-type PCB

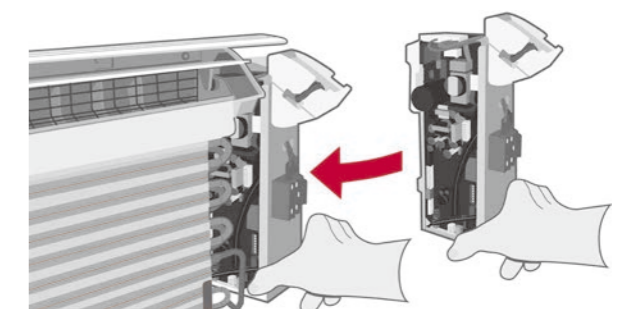

STANDARD INVERTER (R32)

UQ09F / UQ12F / UQ18F



UUA1 ULO UUB1 U20



LG participates in the ECP programme for EUROVENT AC program.
Check ongoing validity of certification
: www.eurovent-certification.com

COMBINATION				9	12	18
Capacity	Cooling	Min. / Rated / Max.	kW	1.5 / 2.6 / 3.4	1.5 / 3.5 / 4.0	2.0 / 5.0 / 5.8
	Heating	Min. / Rated / Max.	kW	1.6 / 3.1 / 3.9	1.6 / 4.0 / 4.3	2.0 / 4.9 / 5.4
Power Input (Set)	Cooling	Min. / Rated / Max.	kW	0.30 / 0.65 / 0.91	0.30 / 1.00 / 1.46	0.40 / 1.75 / 2.45
	Heating	Min. / Rated / Max.	kW	0.30 / 0.74 / 1.08	0.30 / 1.05 / 1.58	0.30 / 1.56 / 2.11
Running Current	Cooling	Rated	A	2.9	4.4	8.3
	Heating	Rated	A	3.3	4.7	8.0
EER / COP			kWh / kWh	4.00 / 4.20	3.50 / 3.80	2.85 / 3.14
SEER / SCOP			kWh / kWh	6.5 / 4.0	6.4 / 4.0	5.8 / 3.8
Pdesign	Cooling @ 35°C		kW	2.6	3.5	5
	Heating @ -10°C		kW	2.8	3	3.8
Seasonal Energy Label	Cooling / Heating		-	A++ / A+	A++ / A+	A+ / A
Annual Energy Consumption	Cooling / Heating		kWh	140 / 980	191 / 1,050	302 / 1,396
Dehumidification Rate			l/h	0.7	1.3	2.4
ODU Sound Pressure Level	Cooling / Heating	Rated	dB(A)	49 / 52	49 / 52	47 / 52
ODU Sound Power Level	Cooling	Rated	dB(A)	65	65	63
Piping Connections	Liquid		mm (inch)	Ø6.35 (1/4)	Ø6.35 (1/4)	Ø6.35 (1/4)
	Gas		mm (inch)	Ø9.52 (3/8)	Ø9.52 (3/8)	Ø12.7 (1/2)
	Connections Method		-	Flared	Flared	Flared
Operation Range (Outdoor)	Cooling	Min. / Max.	°C	-15 / 50	-15 / 50	-15 / 50
	Heating	Min. / Max.	°C	-20 / 18	-20 / 18	-20 / 18
INDOOR				UQ09F NAO	UQ12F NAO	UQ18F NAO
Power Supply			Ø / V / Hz	1 / 220-240 / 50	1 / 220-240 / 50	1 / 220-240 / 50
Power Input (IDU)		H / M / L	W	37 / 30 / 25	37 / 30 / 25	44 / 39 / 35
Air Flow Rate		H / M / L	m³/min	8.5 / 6.7 / 5.0	8.5 / 6.7 / 5.0	10.1 / 8.6 / 7.2
Dimensions	Body	W x H x D	mm	700 x 600 x 210	700 x 600 x 210	700 x 600 x 210
Weight	Body		kg	16.3	16.3	16.3
Sound Pressure Level	Cooling	H / M / L	dB(A)	38 / 32 / 27	38 / 32 / 27	44 / 39 / 35
Sound Power Level	Cooling	Max.	dB(A)	59	59	60
Piping Connections	Drain	O.D. / I.D.	mm	Ø16.7 / 12.2	Ø16.7 / 12.2	Ø16.7 / 12.2
OUTDOOR				UUA1 ULO	UUB1 U20	
Power Supply			Ø / V / Hz	1 / 220-240 / 50	1 / 220-240 / 50	
Circuit Breaker		Min.	A	15	20	
Power Supply Cable (Included Earth)			No x mm³	3C x 1.5	3C x 2.5	
Dimensions	Net	W x H x D	mm	770 x 545 x 288	870 x 650 x 330	
Weight	Net		kg	33.3	44.5	
Compressor	Type		-	Twin Rotary	Twin Rotary	
	Type		-	R32	R32	
	GWEP (Global Warming Potential)		-	675	675	
	Precharged Amount		kg	1.0	1.2	
	t-CO ₂ eq		-	0.675	0.81	
Refrigerant	Additional Charge (After 7.5m)		g/m	20	20	
	Fan	Air Flow Rate	Rated	m³/min x No.	28 x 1	50 x 1
Total Piping Length		Min. / Max.	m	5 / 30	5 / 30	
Piping Elevation	IDU - ODU	Max.	m	30	30	

Note :

- Due to our policy of innovation some specifications may be changed without notification.
- Performances are based on the following conditions (It is accordance with EN14511)
 - Cooling : Indoor Ambient Temp 27°C DB / 19°C WB, Outdoor Ambient Temp 35°C DB / 24°C WB
 - Heating : Indoor Ambient Temp 20°C DB / 15°C WB, Outdoor Ambient Temp 7°C DB / 6°C WB
 - Interconnected Pipe is standard length and difference of Elevation (Outdoor - Indoor Unit) is 0m.
- Sound Level Values are measured at Noise Measuring chamber accordance with standard. Therefore, these values depend on the ambient conditions and values are normally higher in actual operation.
- This product contains fluorinated greenhouse gases. (R32)

FLOOR STANDING



Stylish Design

The new LG floor standing air conditioner which is Red Dot design award winner 2013, is ideal for modern interiors in your home or office.



Quick Response

Offering powerful cooling, the commercial air conditioning system can reach a set temperature in a shorter period of time. Meanwhile, the Power Heating function provides the optimal airflow angle, guaranteeing a faster heating performance.

Cooling

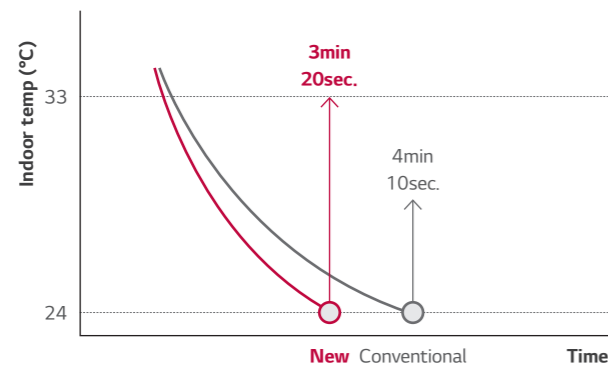

Heating

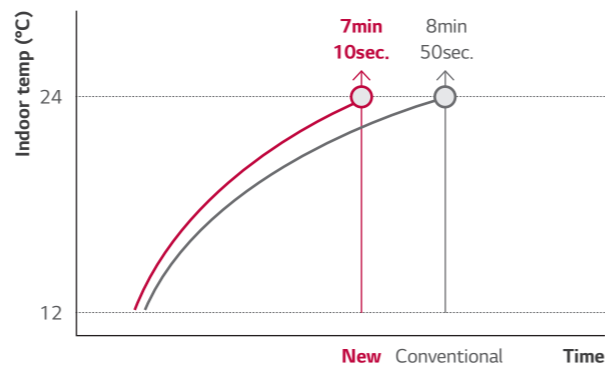

Powerful Air Flow

The new LG floor standing air conditioner is efficient for using in large areas due to its powerful cooling and heating operation. The powerful air speed and volume means the air flow can reach up to 20m away from the air conditioner.

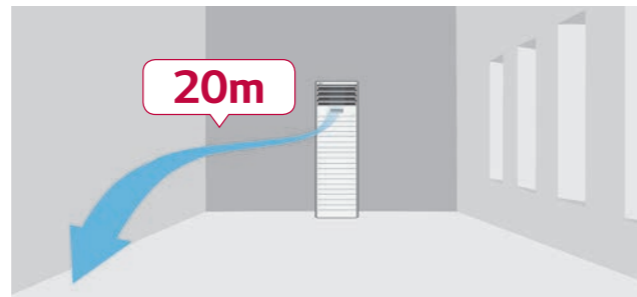

STANDARD INVERTER (R410A)

UP48



LG participates in the ECP programme for EUROVENT AC program. Check ongoing validity of certification : www.eurovent-certification.com

UU48W U32 UU49W U32



INDOOR				UP48 NT2	
Capacity	Cooling	Min. / Nom. / Max.	kW	6.0 / 13.4 / 15.2	
	Heating	Min. / Nom. / Max.	kW	6.0 / 15.5 / 17.1	
Low Temperature Capacity	Heating -7°C	Max.	kW	16.0	
	Cooling	Nom.	kW	4.2	
Power Input (Set)	Heating	Nom.	kW	4.5	
		Nom.	W	200	
Running Current	Cooling / Heating	Nom.	A	18.1 / 19.5	
Power Supply			Ø / V / Hz	1 / 220-240 / 50	
EER				3.21	
COP				3.41	
SEER				5.05	
SCOP				3.51	
Pdesign (@ -10°C)			kW	11.5	
Seasonal Energy Label	Cooling / Heating			-	
Annual Energy Consumption	Cooling / Heating		kWh	-	
	Liquid		mm (inch)	Ø9.52 (3/8)	
Piping Connection	Gas		mm (inch)	Ø15.88 (5/8)	
	Drain	O.D. / I.D.	mm	32 / 25	
Air Flow Rate		High / Medium / Low	m³/min	31 / 27 / 23	
Sound Pressure	Cooling	High / Medium / Low	dB(A)	52 / 49 / 45	
	Heating	Max.	dB(A)	65	
Sound Power	Cooling	Max.	dB(A)	65	
Dehumidification Rate			l/h	5.0	
Dimensions	Body	W x H x D	mm	590 x 1,840 x 460	
Net Weight	Body		kg	50.0	
OUTDOOR				UU48W U32	UU49W U32
Compressor	Type			Twin Rotary	Twin Rotary
Airflow Rate		Nom	m³/min	110	110
Sound Pressure	Cooling	Nom	dB(A)	52	52
	Heating	Nom	dB(A)	54	54
Sound Power	Cooling	Max	dB(A)	72	68
Dimensions	W x H x D		mm	950 x 1,380 x 330	950 x 1,380 x 330
Net Weight			kg	92.0	96.0
Refrigerant	Type			R410A	R410A
	Charge		g	3,400	3,400
	Additional Charge		g/m	40	40
	GWP			2087.5	2087.5
	TCO ₂ eq			7.1	7.1
Operation Range (Outdoor)	Cooling	Min. / Max.	°C DB	-15 / 48	-15 / 48
	Heating	Min. / Max.	°C WB	-18 / 18	-18 / 18
Power Supply			Ø / V / Hz	1 / 220-240 / 50	3 / 380-415 / 50
Power Supply Cable			No. x mm²	3C x 5.0	5C x 5.0
Transmission Cable			No. x mm²	4C x 0.75	4C x 0.75
Circuit Breaker			A	40	20
Piping Length Total		Min. / Max.	m	5 / 75	5 / 75
Piping Elevation Difference	IDU - ODU	Max.	m	30	30
Piping Connection	Liquid		mm (inch)	Ø9.52 (3/8)	Ø9.52 (3/8)
	Gas		mm (inch)	Ø15.88 (5/8)	Ø15.88 (5/8)

Note :

- Due to our policy of innovation some specifications may be changed without notification.
- Performances are based on the following conditions (It is accordance with EN14511)
 - Cooling : Indoor Ambient Temp 27°C DB / 19°C WB, Outdoor Ambient Temp 35°C DB / 24°C WB
 - Heating : Indoor Ambient Temp 20°C DB / 15°C WB, Outdoor Ambient Temp 7°C DB / 6°C WB
 - Interconnected Pipe is standard length and difference of Elevation (Outdoor - Indoor Unit) is 0m.
- Sound Level Values are measured at Noise Measuring chamber accordance with standard. Therefore, these values depend on the ambient conditions and values are normally higher in actual operation.
- This product contains fluorinated greenhouse gases. (R410A)

WALL MOUNTED

Saving Operation Cost

High Energy Efficiency



The advanced technologies of LG achieve lower energy consumption, especially in cooling as can be seen from the SEER class given according to ErP Regulations.

Server room need to be operated continuously. That's why server room owners want to use high energy efficient air conditioning. LG solution saves annual operation cost for server room due to high SEER.

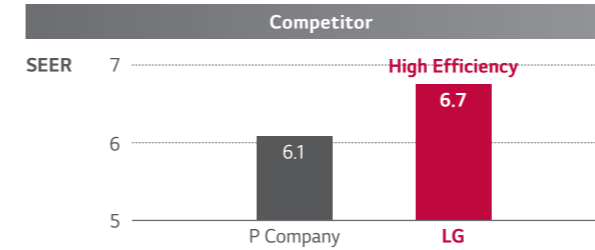

LG Server Room Solution

SEER class (ErP regulation)						
	2.5kW	3.4kW	5.0kW	6.8kW	8.0kW	9.5kW
SEER	7.0 (A++)	6.6 (A++)	6.8 (A++)	6.7 (A++)	7.0 (A++)	6.1 (A++)
SCOP					4.3 (A+)	3.85 (A+)

SEER class (ErP regulation)			
A+++	SEER ≥ 8.5	B	4.6 ≤ SEER < 5.1
A++	6.1 ≤ SEER < 8.5	C	4.1 ≤ SEER < 4.6
A+	5.6 ≤ SEER < 6.1	D	3.6 ≤ SEER < 4.1
A	5.1 ≤ SEER < 5.6		

※ P Company 7.1kW Solution / Outdoor unit : 7.1kW
Indoor unit : 7.1kW Wall mounted unit
※ Performances are based on the following conditions :
• Cooling : Indoor Temp. 27°CDB / 19°CWB, Outdoor Temp. 35°CDB / 24°CWB
• Heating : Indoor Temp. 20°CDB / 15°CWB, Outdoor Temp. 7°CDB / 6°CWB
• Interconnected Pipe is standard length and difference of Elevation (Outdoor - Indoor Unit) is 0m.

Easy Installation

Simplified connection

For small server rooms, LG solution has simple system with only one remote controller. It doesn't need additional control accessories.

Conventional

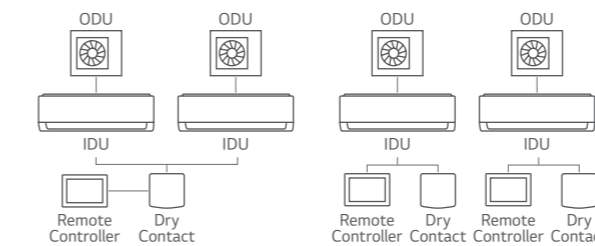

- **Higher product cost**
Conventional system needs dry contact and 3rd party control individual remote controller(s).
- **Higher installation cost**
Need less labor and time for design, installation, cabling and test.
- **Design & Installation difficulties**
It is difficult to make if you need to control more indoor units.

LG Server Room Solution

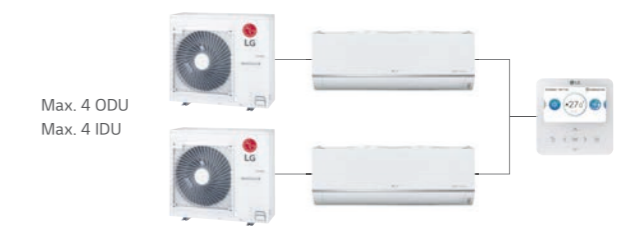

- **Lower product cost**
Only LG remote controller needed for max.4 ODUs and IDUs.
 - **Lower installation cost**
Need less labor and time for design, installation, cabling and test.
 - **Easy Design & Installation**
It provides easy design and installation because it has simple system with LG controller even in case of more number of ODUs and IDUs(Max.4).
- ※ MJ09PC, MJ12PC, MJ18PC, MJ24PC combinations are only available

Detachable Bottom Cover

The bottom cover is detachable when needed, making installation easier. Disassembly or additional support of the unit is unnecessary. Installation can be completed by one individual with LG's patented support tool.

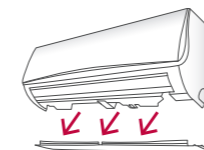

※ This contents of page will be updated later. (Saving operation cost / Easy installation)

Installation Support Clip

A support clip creates adequate space between the wall and the unit for easier installation.

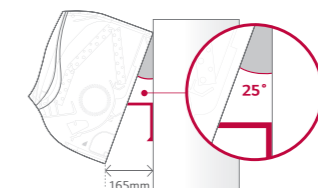

Stable & Reliable Operation

Duty Rotation

Operates more than 2 sets of indoor units alternatively at every set time of operation interval. Rotation interval can be set from 1h to 999h freely.



Air Conditioners' Overworking

- Reducing air conditioner's life time
- Reducing compressor's life expectancy
- The service cost may increase due to air conditioner's overworking

Stable & Safe Operation

- Stable operation due to indoor units take turns
- Less breakdown and keeping server room operation
- Increase air conditioner's life expectancy
- Rotation interval can be set from 1h to 999h freely.

Operation Scenario

When the number of the indoor units : 2

If the interval time is set 24h(default),

- 1 While IDU #1 operates during interval time, IDU #2 is on standby.
- 2 IDU #2 operates next 24 hours, and IDU #1 is on standby.

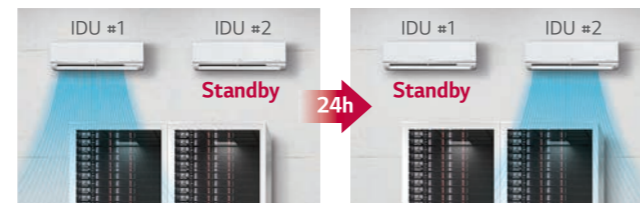

Failure Back-up

If systems in operation have error and stop, the standby unit starts operation automatically.

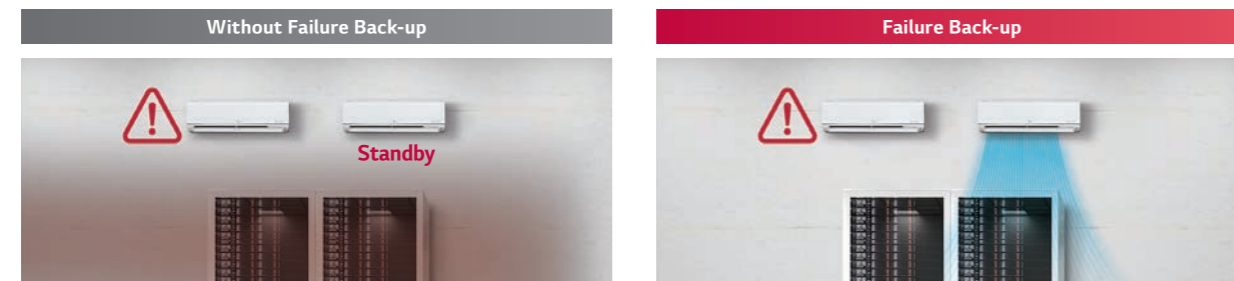

Server can be Shut Down

- Server room overheated and server can be shut down.
- Probability of increased service cost
- Need manual monitoring and operation for failure

Stable & Safe Operation

- Stable operation because the operation error can be covered by failure back-up operation
- Continue server operations and decrease risk
- Protect server from overheating
- Less manual work

Operation Scenario

When the number of the indoor units : 2

- 1 When duty rotation is enabled, IDU #1 is in operation and IDU #2 is on standby.
- 2 If an error occurs on IDU #1, standby unit starts operation.
- 3 After the error is cleared, IDU #2 goes back to standby.

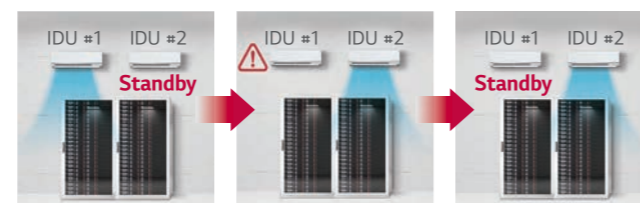

Capacity Back-up

When the difference between the cooling set temperature and the current room temperature is higher than the set temperature difference of capacity back-up, the standby unit operates. When the temperature difference reaches to the set temperature difference, it goes back to the normal duty rotation.



Server can be Overheated

- Sometimes server room can be overheated because of server overload
- Server can be shut down when they overheat continuously
- Air conditioners overload
- Need manual controls for additional cooling

Stable & Safe Operation

- Stable operation due to the over capacity by back-up operation
- Prevent air conditioners from overload
- Protect server from overheating
- No need for manual controls as they protect from overheating automatically

Operation Scenario

When the number of the indoor units : 2

The set temperature difference is A, and the difference between the cooling set temperature and the current room temperature is B,

- 1 When duty rotation is enabled, IDU #1 is in operation and IDU #2 is on standby.
- 2 If B is higher than A, the standby unit starts operation.
- 3 When B goes down and remains below A for some time, The backup unit stops and goes back to standby mode.

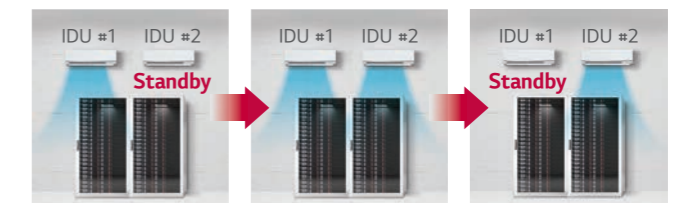

If cooling set temperature is 22°C and the set temperature difference is 4°C, when current temperature goes above 26°C, the standby unit starts operation. If current temperature drops and remains below 26°C for some time, the backup unit stops.

* Duty rotation, capacity back-up, failure back-up function will be available from 2021.2Q - Applied models : MJ09PC, MJ12PC, MJ18PC, MJ24PC only

Wide Operational Range

In case of the server room, continuous cooling is required all year round, and outdoor unit must be stable in the outdoor harsh cold temperature. LG Single split has wide operation range in cooling down continuously from -15°C and up to 48°C.

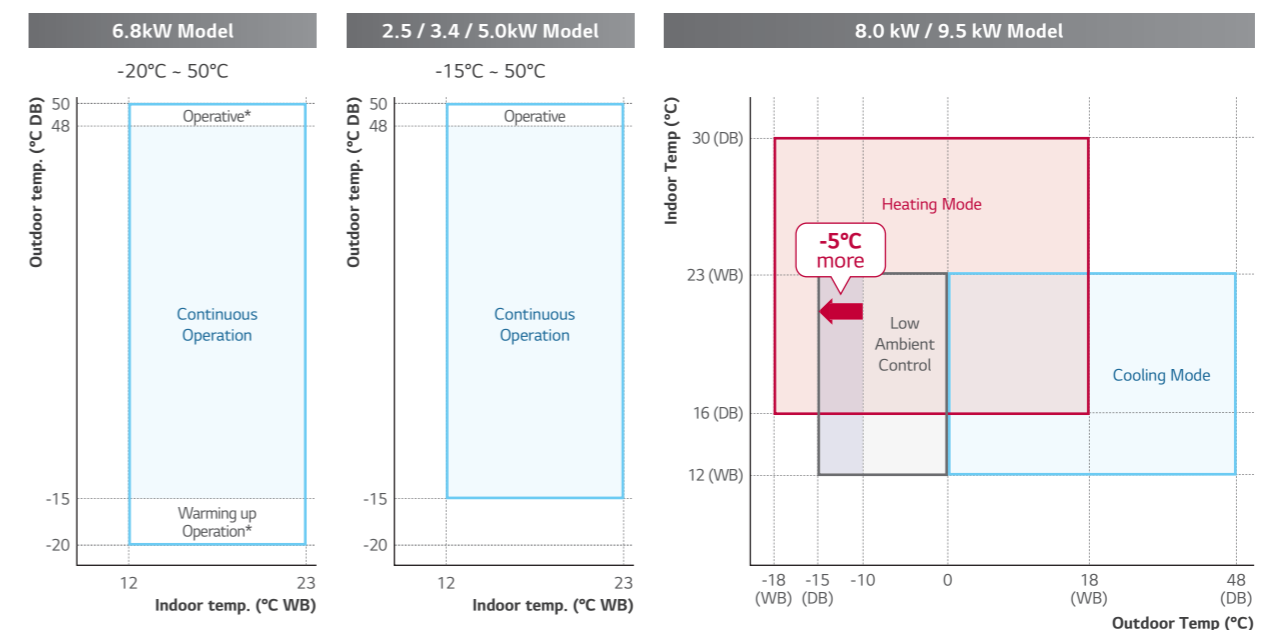

* Warming up operation and operative means that the outdoor unit operates to reach the range of continuous operating, however it may not operate continuously due to safety or protection logic.

STANDARD INVERTER (R32)

MJ09PC / MJ12PC



UUA1 ULO



LG participates in the ECP programme for EUROVENT AC program.
Check ongoing validity of certification
: www.eurovent-certification.com

COMBINATION				9	12
Capacity	Cooling	Min. / Rated / Max.	kW	1.50 / 2.50 / 3.20	1.50 / 3.50 / 4.00
	Heating	Min. / Rated / Max.	kW	1.80 / 3.20 / 3.70	1.80 / 4.00 / 4.40
Power Input	Cooling	Min. / Rated / Max.	kW	0.30 / 0.58 / 0.84	0.33 / 0.97 / 1.48
	Heating	Min. / Rated / Max.	kW	0.30 / 0.71 / 0.85	0.33 / 1.00 / 1.48
Running Current	Cooling	Rated	A	2.60	4.40
	Heating	Rated	A	3.20	4.50
EER / COP			kWh / kWh	4.30 / 4.50	3.60 / 4.00
SEER / SCOP			kWh / kWh	7.00 / 4.00	6.60 / 4.00
P Design	Cooling @ 35°C		kW	2.5	3.5
	Heating @-10°C		kW	2.8	2.8
Seasonal Energy Label	Cooling / Heating		-	A++ / A+	A++ / A+
Annual Energy Consumption	Cooling / Heating		kWh	125 / 980	186 / 980
Dehumidification Rate			ℓ/h	1.90	1.90
ODU Sound Pressure Level	Cooling	Rated	dB(A)	49	49
	Heating	Rated	dB(A)	52	52
ODU Sound Power Level	Cooling	Rated	dB(A)	65	65
	Heating	Rated	dB(A)	-	-
Piping Connections	Liquid	Outer Dia.	mm (inch)	Ø 6.35 (1/4)	Ø 6.35 (1/4)
	Gas	Outer Dia.	mm (inch)	Ø 9.52 (3/8)	Ø 9.52 (3/8)
	Connections Method			Flare	Flare
Operation Range (Outdoor)	Cooling	Min. / Max.	°C	-15 / 50	-15 / 50
	Heating	Min. / Max.	°C	-20 / 18	-20 / 18
INDOOR				MJ09PC NSJ	MJ12PC NSJ
Power Supply			Ø / V / Hz	1 / 220-240 / 50	1 / 220-240 / 50
Power Input	Min. / Nom. / Max.		W	11 / 18 / 30	11 / 19 / 30
Air Flow Rate	H / M / L		m³/min	7.6 / 6.2 / 4.8	8.0 / 6.6 / 5.5
Dimensions	Body	W x H x D	mm	818 x 316 x 189	818 x 316 x 189
	Weight		kg (lbs)	8.2 (18.1)	8.2 (18.1)
Sound Pressure Level	Cooling	H / M / L	dB(A)	36 / 32 / 27	38 / 34 / 29
	Sound Power Level	Max.	dB(A)	56	56
Piping Connections	Drain	O.D. / I.D.	mm	Ø 21.5 / 16.0	Ø 21.5 / 16.0
OUTDOOR				UUA1 ULO	
Power Supply			Ø / V / Hz	1 / 220-240 / 50	
Circuit Breaker	Min.		A	15	
Power Supply Cable (included Earth)			No. x mm²	3C x 1.5	
Dimensions	Net	W x H x D	mm	770 x 545 x 288	
Weight	Net		kg	33.3	
Compressor	Type			Twin Rotary	
	Type			R32	
Refrigerant	GWP (Global Warming Potential)			675	
	Precharged Amount		kg	1.0	
	t-CO ₂ eq.			0.675	
	Control			EEV	
	Additional Charging Volume		g/m	20	
Air Flow Rate	Rated		m³/min x No.	28 x 1	
Total Piping Length	Min. / Max.		m	5.0 / 30.0	
Piping Elevation	IDU-ODU	Max.	m	30	

STANDARD INVERTER (R32)

MJ18PC / MJ24PC



UUB1 U20

UUC1 U40



LG participates in the ECP programme for EUROVENT AC program.
Check ongoing validity of certification
: www.eurovent-certification.com

COMBINATION				18	24
Capacity	Cooling	Min. / Rated / Max.	kW	2.00 / 5.00 / 7.00	2.70 / 6.80 / 7.70
	Heating	Min. / Rated / Max.	kW	2.30 / 5.80 / 6.10	3.00 / 6.90 / 7.24
Power Input	Cooling	Min. / Rated / Max.	kW	0.30 / 1.39 / 2.63	0.40 / 2.00 / 2.57
	Heating	Min. / Rated / Max.	kW	0.30 / 1.71 / 1.96	0.40 / 2.33 / 2.50
Running Current	Cooling	Rated	A	6.30	9.10
	Heating	Rated	A	7.70	10.60
EER / COP			kWh / kWh	3.61 / 3.40	3.40 / 3.00
SEER / SCOP			kWh / kWh	6.80 / 4.00	6.70 / 3.90
P Design	Cooling @ 35°C		kW	5.0	6.8
	Heating @-10°C		kW	4.1	5.0
Seasonal Energy Label	Cooling / Heating		-	A++ / A+	A++ / A
Annual Energy Consumption	Cooling / Heating		kWh	257 / 1,365	355 / 1,795
Dehumidification Rate			ℓ/h	3.35	3.50
ODU Sound Pressure Level	Cooling	Rated	dB(A)	47	48
	Heating	Rated	dB(A)	52	52
ODU Sound Power Level	Cooling	Rated	dB(A)	63	65
	Heating	Rated	dB(A)	-	-
Piping Connections	Liquid	Outer Dia.	mm (inch)	Ø 6.35 (1/4)	Ø 9.52 (3/8)
	Gas	Outer Dia.	mm (inch)	Ø 12.7 (1/2)	Ø 15.88 (5/8)
	Connections Method			Flare	Flare
Operation Range (Outdoor)	Cooling	Min. / Max.	°C	-15 / 50	-20 / 50
	Heating	Min. / Max.	°C	-20 / 18	-20 / 18
INDOOR				MJ18PC NSK	MJ24PC NSK
Power Supply			Ø / V / Hz	1 / 220-240 / 50	1 / 220-240 / 50
Power Input	Min. / Nom. / Max.		W	26 / 39 / 60	27 / 45 / 60
Air Flow Rate	H / M / L		m³/min	15.8 / 12.4 / 10.0	16.9 / 12.8 / 10.4
Dimensions	Body	W x H x D	mm	975 x 354 x 209	975 x 354 x 209
	Weight		kg (lbs)	10.9 (24.0)	11.5 (25.4)
Sound Pressure Level	Cooling	H / M / L	dB(A)	44 / 38 / 34	46 / 41 / 36
	Sound Power Level	Max.	dB(A)	59	65
Piping Connections	Drain	O.D. / I.D.	mm	Ø 21.5 / 16.0	Ø 21.5 / 16.0
OUTDOOR				UUB1 U20	UUC1 U40
Power Supply			Ø / V / Hz	1 / 220-240 / 50	1 / 220-240 / 50
Circuit Breaker	Min.		A	20	25
Power Supply Cable (included Earth)			No. x mm²	3C x 2.5	3C x 2.5
Dimensions	Net	W x H x D	mm	870 x 650 x 330	950 x 834 x 330
Weight	Net		kg	44.5	57.7
Compressor	Type			Twin Rotary	
	Type			R32	
Refrigerant	GWP (Global Warming Potential)			675	
	Precharged Amount		kg	1.2	
	t-CO ₂ eq.			0.810	
	Control			EEV	
	Additional Charging Volume		g/m	20	
Air Flow Rate	Rated		m³/min x No.	50 x 1	58 x 1
Total Piping Length	Min. / Max.		m	5.0 / 35.0	5.0 / 50.0
Piping Elevation	IDU-ODU	Max.	m	30	30

STANDARD INVERTER (R32)

US30F / US36F



UUC1 U40 UUD1 U30 UUD3 U30



LG participates in the ECP programme for EUROVENT AC program.
Check ongoing validity of certification
: www.eurovent-certification.com

COMBINATION				30	36	36
Capacity	Cooling	Min. / Rated / Max.	kW	3.2 / 8.0 / 9.0	3.8 / 9.5 / 12.5	3.8 / 9.5 / 12.5
	Heating	Min. / Rated / Max.	kW	3.6 / 9.0 / 10.0	4.3 / 10.8 / 13.4	4.3 / 10.8 / 13.4
Power Input (Set)	Cooling	Min. / Rated / Max.	kW	0.50 / 2.28 / 3.17	0.30 / 2.57 / 3.91	0.30 / 2.57 / 3.91
	Heating	Min. / Rated / Max.	kW	0.50 / 2.5 / 3.20	0.50 / 2.77 / 3.77	0.50 / 2.77 / 3.77
Running Current	Cooling	Rated	A	10.1	11.4	4.1
	Heating	Rated	A	11.1	12.2	4.4
EER / COP			kWh / kWh	3.51 / 3.60	3.70 / 3.90	3.70 / 3.90
SEER / SCOP			kWh / kWh	7.0 / 4.3	6.10 / 3.85	6.10 / 3.85
Pdesign	Cooling @ 35°C		kW	8	9.5	9.5
	Heating @ -10°C		kW	5.4	8.7	8.7
Seasonal Energy Label	Cooling / Heating		-	A++ / A+	A++ / A	A++ / A
Annual Energy Consumption	Cooling / Heating		kWh	400 / 1,758	545 / 3,164	545 / 3,164
Dehumidification Rate			l/h	2.9	3.8	3.8
ODU Sound Pressure Level	Cooling / Heating	Rated	dB(A)	50 / 52	50 / 50	50 / 50
ODU Sound Power Level	Cooling	Rated	dB(A)	68	66	66
Piping Connections	Liquid		mm (inch)	Ø9.52 (3/8)	Ø9.52 (3/8)	Ø9.52 (3/8)
	Gas		mm (inch)	Ø15.88 (5/8)	Ø15.88 (5/8)	Ø15.88 (5/8)
	Connections Method		-	Flared	Flared	Flared
Operation Range (Outdoor)	Cooling	Min. / Max.	°C	-20 - 50	-20 - 52	-20 - 52
	Heating	Min. / Max.	°C	-20 - 18	-25 - 18	-25 - 18
INDOOR				US30F NRO	US36F NRO	US36F NRO
Power Supply			Ø / V / Hz	1 / 220-240 / 50	1 / 220-240 / 50	1 / 220-240 / 50
Power Input (IDU)		H / M / L	W	47 / 42 / 36	65 / 47 / 42	65 / 47 / 42
Air Flow Rate		H / M / L	m3/min	21 / 17 / 13	25 / 21 / 17	25 / 21 / 17
Dimensions	Body	W x H x D	mm	1,200 x 360 x 265	1,200 x 360 x 265	1,200 x 360 x 265
Weight	Body		kg	18.3	18.3	18.3
Sound Pressure Level	Cooling	H / M / L	dB(A)	46.0 / 42.0 / 38.0	51.0 / 46.0 / 42.0	51.0 / 46.0 / 42.0
Sound Power Level	Cooling	Max.	dB(A)	62	65	65
Piping Connections	Drain	O.D. / I.D.	mm	Ø21.5 / 16.0	Ø21.5 / 16.0	Ø21.5 / 16.0
OUTDOOR				UUC1 U40	UUD1 U30	UUD3 U30
Power Supply			Ø / V / Hz	1 / 220-240 / 50	1 / 220-240 / 50	3 / 380-415 / 50
Circuit Breaker		Min.	A	25	40	20
Power Supply Cable (Included Earth)			No x mm ³	3C x 2.5	3C x 6.0	5C x 2.5
Dimensions	Net	W x H x D	mm	950 x 834 x 330	950 x 1,380 x 330	950 x 1,380 x 330
Weight	Net		kg	57.7	85	85
Compressor	Type		-	Twin Rotary	Inverter Scroll	Inverter Scroll
	Type		-	R32	R32	R32
Refrigerant	GWP (Global Warming Potential)		-	675	675	675
	Precharged Amount		kg	1.9	3.0	3.0
	t-CO ₂ eq		-	1.283	2.025	2.025
	Additional Charge (After 7.5m)		g/m	40	40	40
Fan	Air Flow Rate	Rated	m ³ /min x No.	58 x 1	55 x 2	55 x 2
Total Piping Length		Min. / Max.	m	5 / 50	5 / 85	5 / 85
Piping Elevation	IDU - ODU	Max.	m	30	30	30

Note :

- Due to our policy of innovation some specifications may be changed without notification.
- Performances are based on the following conditions (It is accordance with EN14511)
 - Cooling : Indoor Ambient Temp 27°C DB / 19°C WB, Outdoor Ambient Temp 35°C DB / 24°C WB
 - Heating : Indoor Ambient Temp 20°C DB / 15°C WB, Outdoor Ambient Temp 7°C DB / 6°C WB
 - Interconnected Pipe is standard length and difference of Elevation (Outdoor - Indoor Unit) is 0m.
- Sound Level Values are measured at Noise Measuring chamber accordance with standard. Therefore, these values depend on the ambient conditions and values are normally higher in actual operation.
- This product contains fluorinated greenhouse gases. (R32)

COMPACT INVERTER (R32)

US30F / US36F



LG participates in the ECP programme for EUROVENT AC program.
Check ongoing validity of certification
: www.eurovent-certification.com

UUB1 U20 UUC1 U40



COMBINATION				30	36
Capacity	Cooling	Min. / Rated / Max.	kW	3.0 / 7.5 / 8.3	3.8 / 9.5 / 10.6
	Heating	Min. / Rated / Max.	kW	3.1 / 7.7 / 8.5	4.3 / 10.8 / 11.5
Power Input (Set)	Cooling	Min. / Rated / Max.	kW	0.50 / 2.31 / 2.77	0.60 / 3.06 / 3.67
	Heating	Min. / Rated / Max.	kW	0.40 / 2.14 / 2.78	0.60 / 3.0 / 3.72
Running Current	Cooling	Rated	A	10.1	13.6
	Heating	Rated	A	9.3	13.3
EER / COP			kWh / kWh	3.25 / 3.60	3.10 / 3.60
SEER / SCOP			kWh / kWh	6.8 / 4.1	6.4 / 4.1
Pdesign	Cooling @ 35°C		kW	7.5	9.5
	Heating @ -10°C		kW	4.3	5.8
Seasonal Energy Label	Cooling / Heating		-	A++ / A+	A++ / A+
Annual Energy Consumption	Cooling / Heating		kWh	386 / 1,468	520 / 1,980
Dehumidification Rate			l/h	3.0	3.5
ODU Sound Pressure Level	Cooling / Heating	Rated	dB(A)	50 / 54	54 / 56
ODU Sound Power Level	Cooling	Rated	dB(A)	67	70
Piping Connections	Liquid		mm (inch)	Ø9.52 (3/8)	Ø9.52 (3/8)
	Gas		mm (inch)	Ø15.88 (5/8)	Ø15.88 (5/8)
	Connections Method		-	Flared	Flared
Operation Range (Outdoor)	Cooling	Min. / Max.	°C	-10 - 48	-20 - 50
	Heating	Min. / Max.	°C	-15 - 18	-15 - 18
INDOOR				US30F NRO	US36F NRO
Power Supply			Ø / V / Hz	1 / 220-240 / 50	1 / 220-240 / 50
Power Input (IDU)		H / M / L	W	47 / 42 / 36	65 / 47 / 42
Air Flow Rate		H / M / L	m3/min	21 / 17 / 13	25 / 21 / 17
Dimensions	Body	W x H x D	mm	1,200 x 360 x 265	1,200 x 360 x 265
Weight	Body		kg	18.3	18.3
Sound Pressure Level	Cooling	H / M / L	dB(A)	46.0 / 42.0 / 38.0	51.0 / 46.0 / 42.0
Sound Power Level	Cooling	Max.	dB(A)	62	65
Piping Connections	Drain	O.D. / I.D.	mm	Ø21.5 / 16.0	Ø21.5 / 16.0
OUTDOOR				UUB1 U20	UUC1 U40
Power Supply			Ø / V / Hz	1 / 220-240 / 50	1 / 220-240 / 50
Circuit Breaker		Min.	A	20	25
Power Supply Cable (Included Earth)			No x mm ³	3C x 2.5	3C x 2.5
Dimensions	Net	W x H x D	mm	870 x 650 x 330	950 x 834 x 330
Weight	Net		kg	44.5	57.7
Compressor	Type		-	Twin Rotary	Twin Rotary
	Type		-	R32	R32
Refrigerant	GWP (Global Warming Potential)		-	675	675
	Precharged Amount		kg	1.2	1.9
	t-CO ₂ eq		-	0.81	1.283
	Additional Charge (After 7.5m)		g/m	40	40
Fan	Air Flow Rate	Rated	m ³ /min x No.	50 x 1	58 x 1
Total Piping Length		Min. / Max.	m	5 / 35	5 / 50
Piping Elevation	IDU - ODU	Max.	m	30	30

Note :

- Due to our policy of innovation some specifications may be changed without notification.
- Performances are based on the following conditions (It is accordance with EN14511)
 - Cooling : Indoor Ambient Temp 27°C DB / 19°C WB, Outdoor Ambient Temp 35°C DB / 24°C WB
 - Heating : Indoor Ambient Temp 20°C DB / 15°C WB, Outdoor Ambient Temp 7°C DB / 6°C WB
 - Interconnected Pipe is standard length and difference of Elevation (Outdoor - Indoor Unit) is 0m.
- Sound Level Values are measured at Noise Measuring chamber accordance with standard. Therefore, these values depend on the ambient conditions and values are normally higher in actual operation.
- This product contains fluorinated greenhouse gases. (R32)

AHU SOLUTION



Air Handling Applications

Economically feasible solution for pair application with air handling units.

Return/Room Air Temperature Control

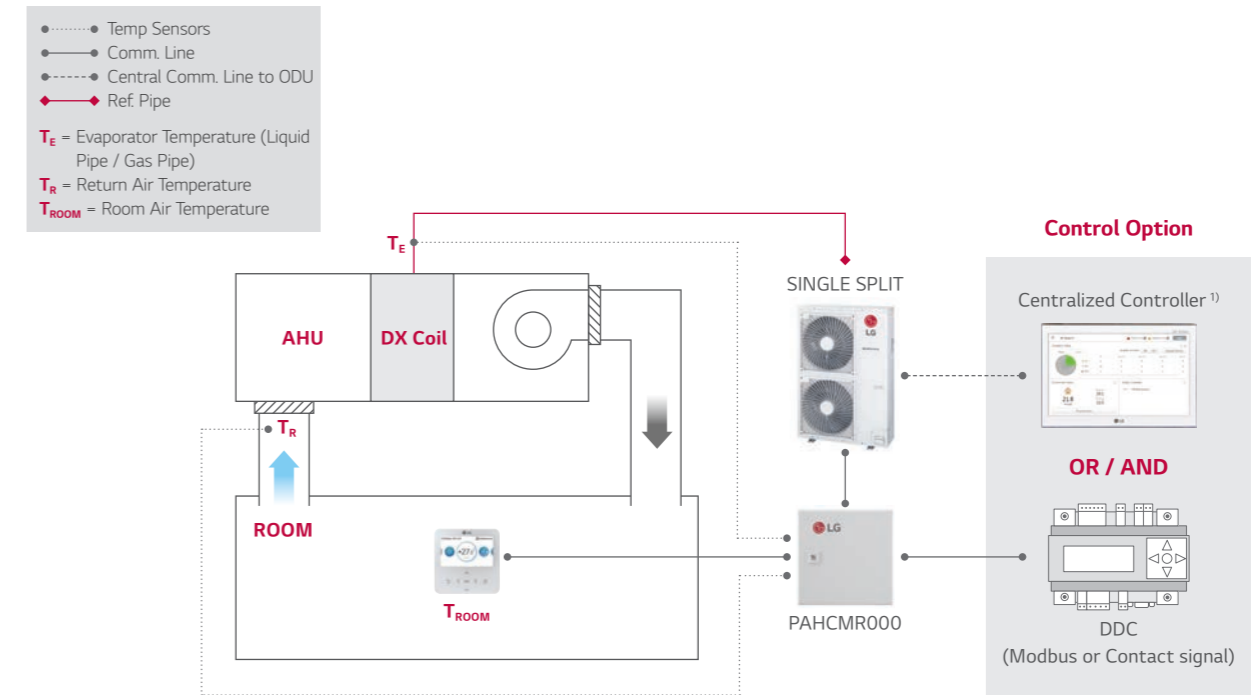

Discharge Air Temperature Control

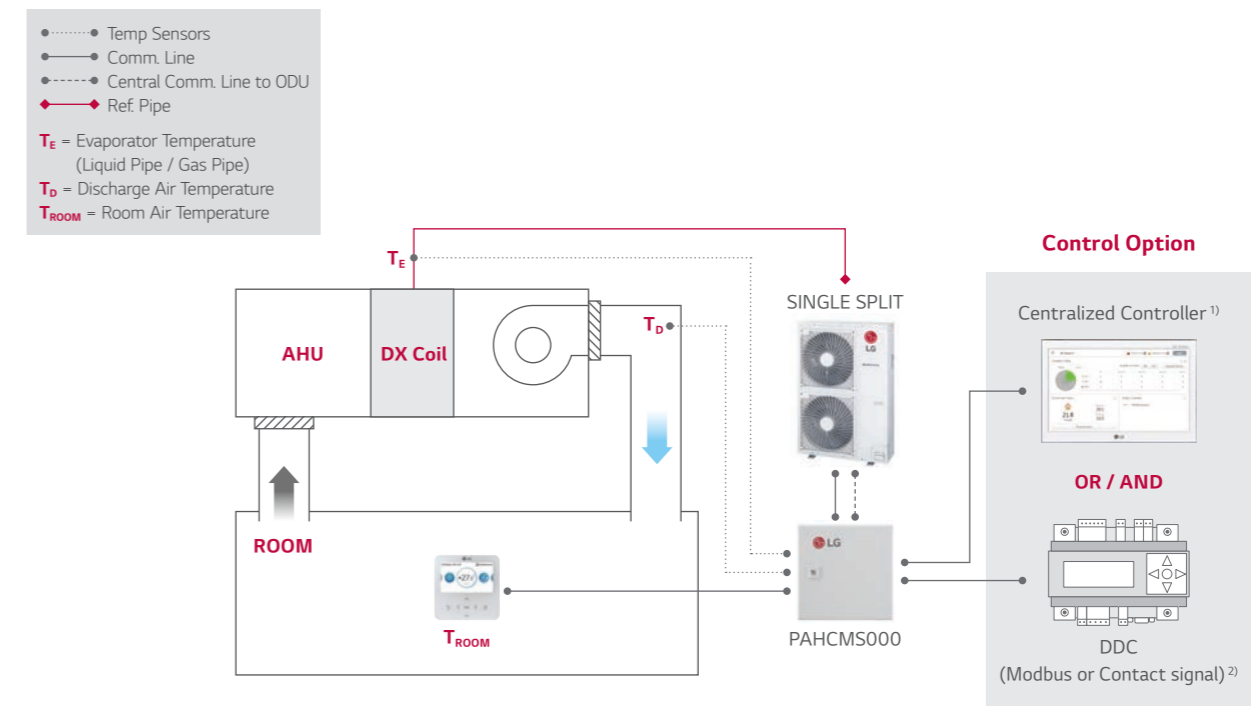

1) PI485(PMNF14A1) is required for using centralized controller.

2) In case of applying DDC with contact signal, discharge air temperature should be measured and controlled by DDC.

3) For more detail, please refer to the PDB of AHU Communication Kit.

Communication Kit



PAHCMR000 / PAHCMS000

Specification

MODEL	COMBINATION		DESCRIPTION	DIMENSIONS (MM)		
	OUTDOOR UNIT	CENTRALIZED CONTROLLER		W	H	D
PAHCMR000	Single Split	•	Return / Room air temperature control by DDC or LG individual / centralized controller	300	300	155
PAHCMS000	Single Split	•	Discharge air temperature control by DDC or LG individual / centralized controller	380	300	155

Function list for Communication kit

FUNCTION LIST*	PAHCMR000	PAHCMS000	NOTE
Comm. Kit Operation	On / Off	On / Off	
Operation Mode ¹⁾	Cooling / Heating	Cooling / Heating	
Return (room) Air Temperature	16-30°C	-	
Control			
Discharge Air Temperature ²⁾	-	16-30°C	Available in case of using DDC with Modbus or LG Control system
Fan Speed ³⁾	Low / Middle / High	Low / Middle / High	It may not be possible depending on the particular condition
Forced Thermal On / Off	On / Off	-	Available in case of using DDC with contact signal
Capacity Control	-	•	Available in case of using DDC with Modbus or contact signal
Monitor			
Comm. Kit Operation	On / Off	On / Off	
Operation Mode ¹⁾	Cooling / Heating	Cooling / Heating	Available in case of using DDC with Modbus or LG Control system
Fan Speed	Low / Middle / High	Low / Middle / High	
Error Alarm	•	•	
Compressor On / Off	On / Off	On / Off	Available in case of using DDC with Modbus or LG individual controller PAHCMR000 doesn't provide this in case of using DDC with contact signal

1) Available operation mode can be varied depending on the setting of AHU Communication Kit.

2) This range may differ depending on the type of controller.

3) To control and monitor the fan speed, DO ports for the fan speed status have to be connected with the fan unit.

* Some of functions may not be possible depending on the setting of AHU Communication Kit. For more details of condition, please refer to the product data book.

Combination Table

Model Name		R32				R410A	
		UUA1 U10	UUB1 U20	UUC1 U40	UUD1 U30 UUD3 U30	UU70W U34	UU85W U74
Capacity Index Range	kBtu/h	9 - 18	18 - 30	24 - 36	36 - 60	70	85
	kW	2.5 - 5.0	5.0 - 8.0	6.8 - 10.0	10.0 - 14.6	20.0	25.0
PAHCMR000		X	0	0	0	0	0
PAHCMS000		X	0	0	0	0	0

ACCESSORIES



LG Wi-Fi Modem

Control conditioners by using internet devices such as Android or iOS smartphones.



PWFMD200

Features

- User can enjoy anytime, anywhere access with Wi-Fi equipped device through LG's ThinQ mobile app.
- This allows the user to access the unit remotely to switch unit on or off before or after leaving the vicinity.
- LG's exclusive Home Appliances control app (LG ThinQ) is available.
- Simple operation for various functions.
 - On / Off
 - Operation Mode
 - Current / Set Temperature
 - Fan Speed
 - Vane Control ¹⁾
 - Reservation (Sleep, Weekly On / Off)
 - Energy Monitoring ²⁾
 - Filter Management
 - Error Check
 - Air Purify ³⁾

Model Name	PWFMD200
Size (W x H x D, mm)	48 x 68 x 14
Interfaceable Products	System Air Conditioner ³⁾
Connection Type	Indoor unit 1:1
Communication Frequency	2.4 GHz
Wireless Standards	IEEE 802.11b/g/n
Mobile Application	LG ThinQ (Android v4.1(Jellybean) or higher, iPhone iOS 9.0 or higher)
Optional Extension Cable	PWYREW000 (10m extension)

Note : 1. Functionality may be different according to each IDU model.
 2. User interface of application shall be revised for its design and contents improvement.
 3. Application is optimized for smartphone use, so it may not be well functioning with tablet devices.
 1) Vane Control may not be possible according to the type of Indoor unit.
 2) LG Centralized controller and PDI installation is required for this function.
 3) For the compatibility with indoor units, regional LG office.

Overview

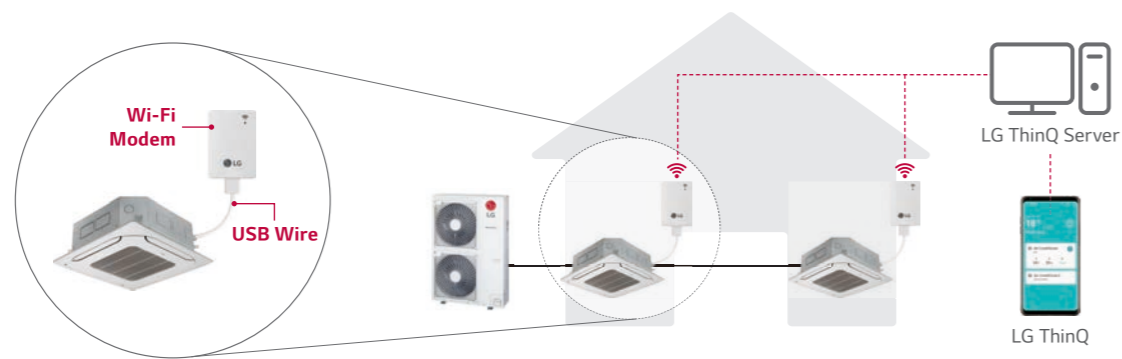

※ Search "LG ThinQ" on Google market or Appstore then download the app.
 ※ Internet service with Wi-Fi connection has to be available.

Standard Wired Remote Controller



Standard III PREMTB100 Standard III PREMTBB10



Standard II PREMTB001 Standard II PREMTBB01

Model Name	PREMTB100 PREMTBB10	PREMTB001 PREMTBB01
Operation Mode	On / Off, Fan Speed Control, Temperature Setting	
Mode Change	Cooling, Heating, Auto, Dehumidification, Fan	
Auto Swing / Vane Control	•	•
Reservation	Simple, Sleep, On / Off, Weekly, Holiday	
Time Display	•	•
Electrical Failure Compensation	•	•
Child Lock	•	•
Operation Status LED	•	•
Indoor Temperature Display	•	•
Wireless Remote Controller Receiver	-	•
Size (W x H x D, mm)	120 x 120 x 16	120 x 121 x 16
Backlight	•	•

※ Refer to each model PDB for applicable models.

Remote Controller



PWLSSB21H

PI 485



PMNFP14A1

Power : Single phase AC 220V 50/60Hz
 Max. no of the indoor units that can be connected : 64 UNITS
 Model applied : RAC / Multi / Single / Thermo V

※ Refer to each product PDB for applicable models.

Dry Contact



PDRYCB000 PDRYCB400



PDRYCB320 PDRYCB500

Model	PDRYCB000	PDRYCB400	PDRYCB320	PDRYCB500
Contact Point	1 Control Point	2 Control Point	8 Control Point	Modbus RTU
Power Input	AC 220V from outside power source	DC 5V & 12V from indoor unit PCB	DC 5V & 12V from indoor unit PCB	DC 5V & 12V from indoor unit PDB
Voltage / Non Voltage Input	-	•	•	-
On / Off Control	•	•	•	•
Lock / Unlock	•	•	•	•
Fan Speed Setting	-	-	-	•
Thermo Off	-	•	•	-
Energy Saving	-	•	-	-
Temperature Setting	-	•	•	•
Error Monitoring	•	•	•	•
Operation Monitoring	•	•	•	•

※ Refer to each product PDB for applicable models.

H-INVERTER (R32)

UT09FH NQ0 / UT12FH NQ0

(Unit : mm)

PART NAME	
1	Gas Pipe Connection
2	Liquid Pipe Connection
3	Drain Pipe Connection
4	Power and Communication Cable Routing Hole
5	Wired Remote Controller Wire Routing Hole
6	Air Inlet
7	Air Outlet
8	Decoration Panel (Accessory)
9	Decoration Corner Cover
10	Decoration Corner Display Cover
11	Flexible Drain Hose
12	Fresh air Intake Hole

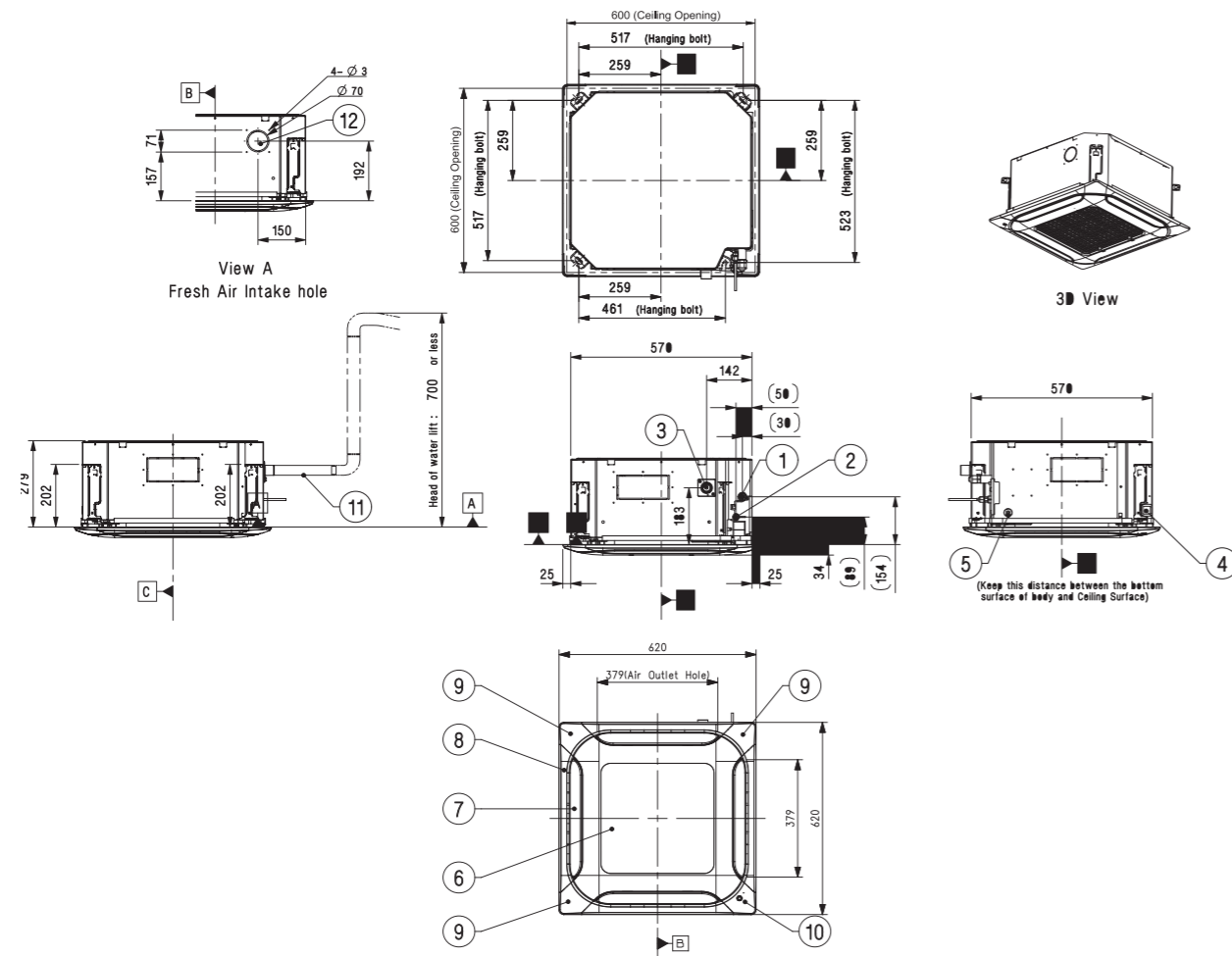

H-INVERTER (R32)

UT18FH NB0

(Unit : mm)

PART NAME	
1	Gas Pipe Connection
2	Liquid Pipe Connection
3	Drain Pipe Connection
4	Power and Communication Cable Routing Hole
5	Wired Remote Controller Wire Routing Hole
6	Air Inlet
7	Air Outlet
8	Decoration Panel (Accessory)
9	Decoration Corner Cover
10	Decoration Corner Display Cover
11	Flexible Drain Hose

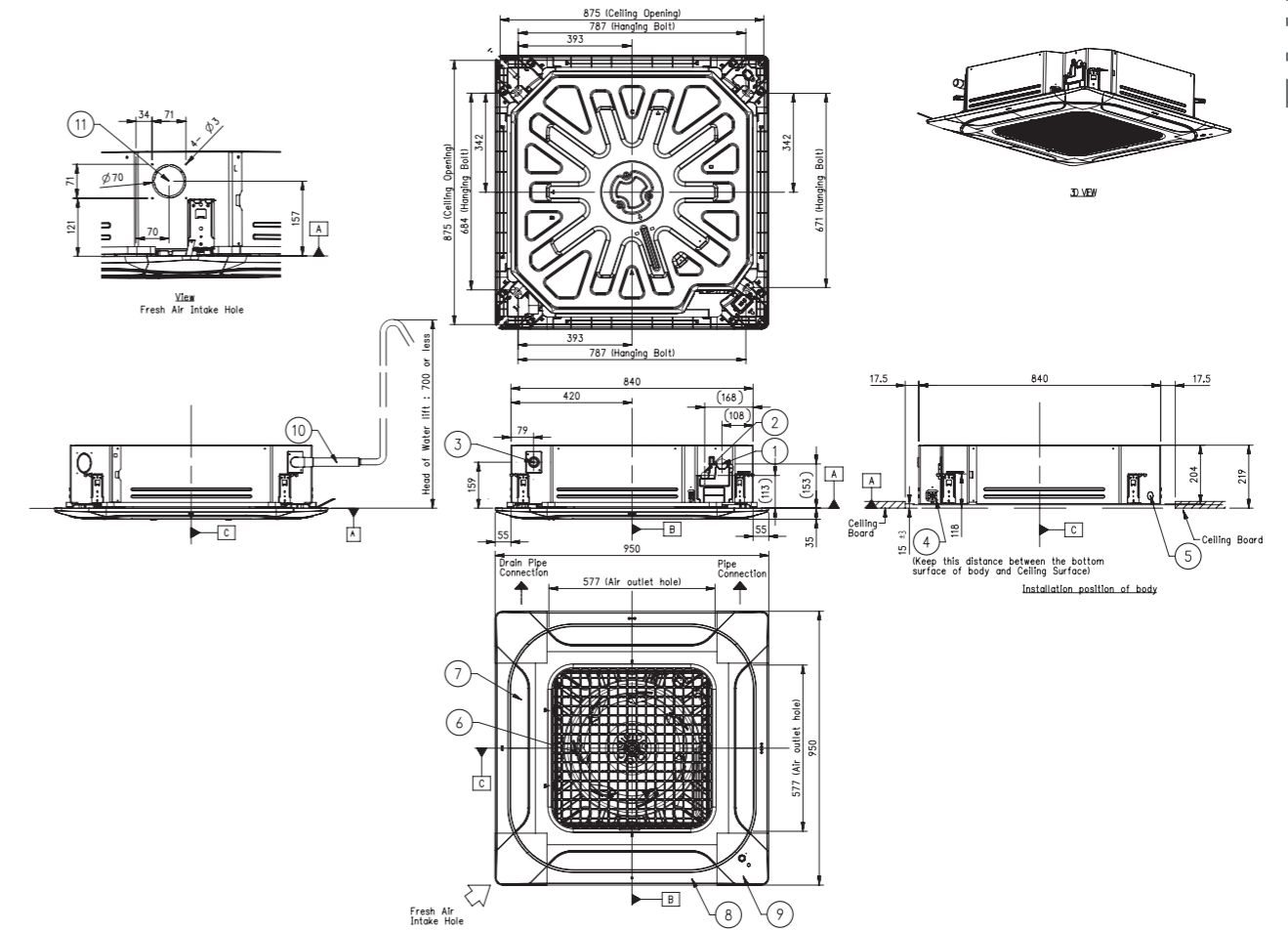

H-INVERTER (R32)

UT24FH NAO / UT30FH NAO / UT36FH NAO / UT42FH NAO
UT48FH NAO / UT60FH NAO

(Unit : mm)

PART NAME	
1	Gas Pipe Connection
2	Liquid Pipe Connection
3	Drain Pipe Connection
4	Power and Communication Cable Routing Hole
5	Wired Remote Controller Wire Routing Hole
6	Air Inlet
7	Air Outlet
8	Decoration Panel (Accessory)
9	Decoration Corner Cover
10	Flexible Drain Hose
11	Fresh Air Intake Hole

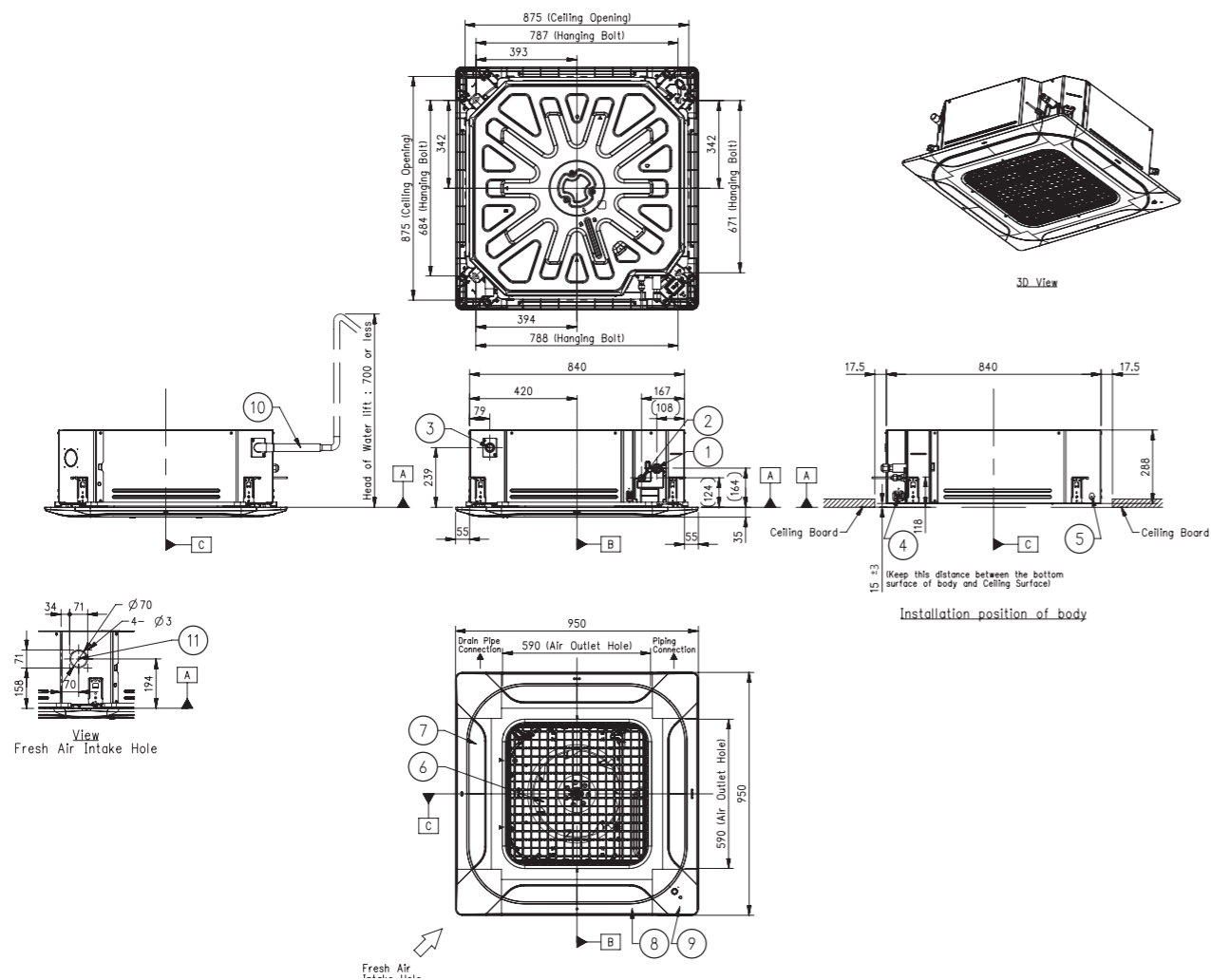

STANDARD INVERTER (R32)

CT09F NR0 / CT12F NR0

(Unit : mm)

PART NAME	
1	Gas Pipe Connection
2	Liquid Pipe Connection
3	Drain Pipe Connection
4	Power and Communication Cable Routing Hole
5	Wired Remote Controller Wire Routing Hole
6	Air Inlet
7	Air Outlet
8	Decoration Panel (Accessory)
9	Decoration Corner Cover
10	Decoration Corner Display Cover
11	Flexible Drain Hose
12	Fresh air Intake Hole

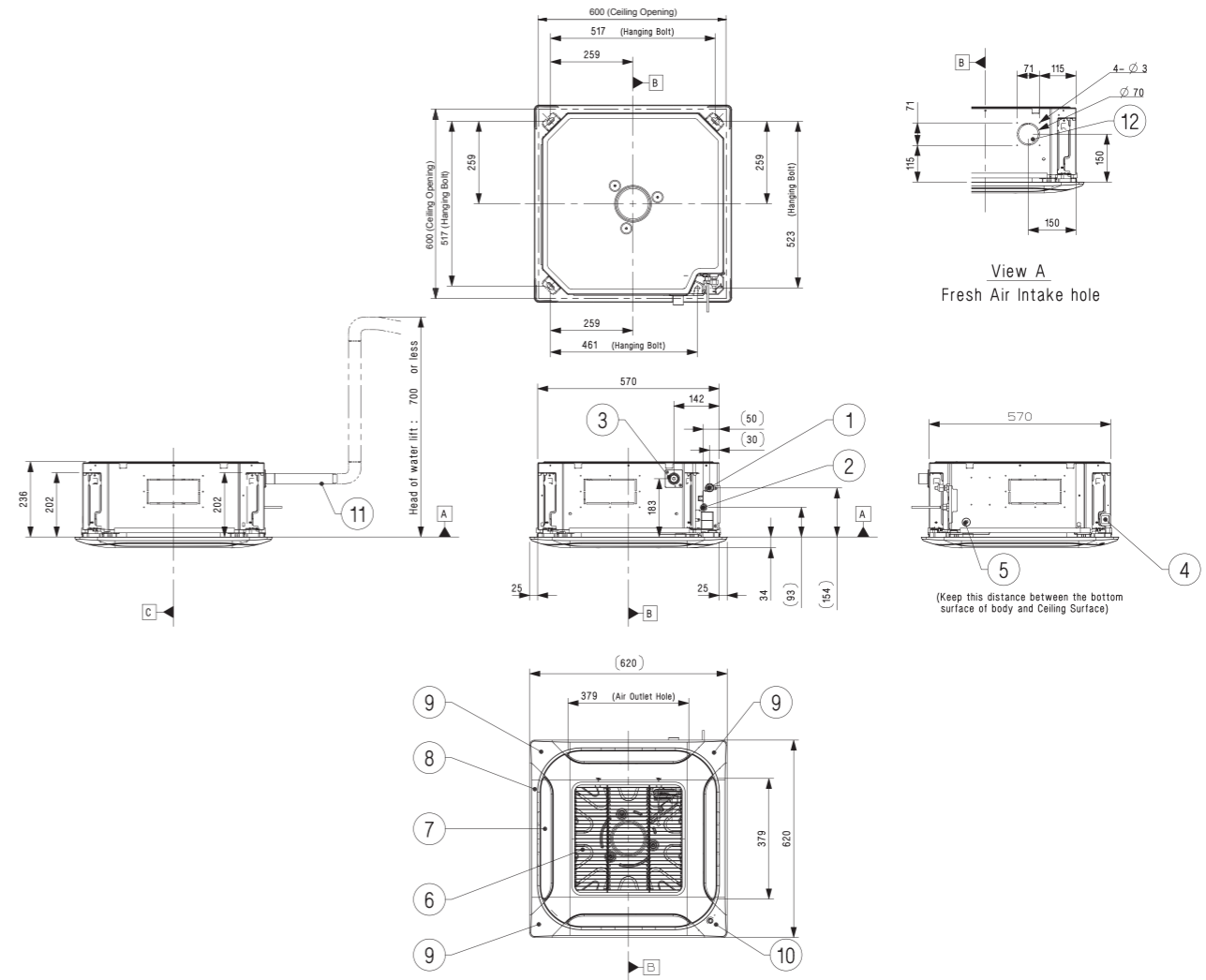

STANDARD / COMPACT INVERTER (R32)

CT18F NQO

(Unit : mm)

PART NAME	
1	Gas Pipe Connection
2	Liquid Pipe Connection
3	Drain Pipe Connection
4	Power and Communication Cable Routing Hole
5	Wired Remote Controller Wire Routing Hole
6	Air Inlet
7	Air Outlet
8	Decoration Panel (Accessory)
9	Decoration Corner Cover
10	Decoration Corner Display Cover
11	Flexible Drain Hose
12	Fresh air Intake Hole

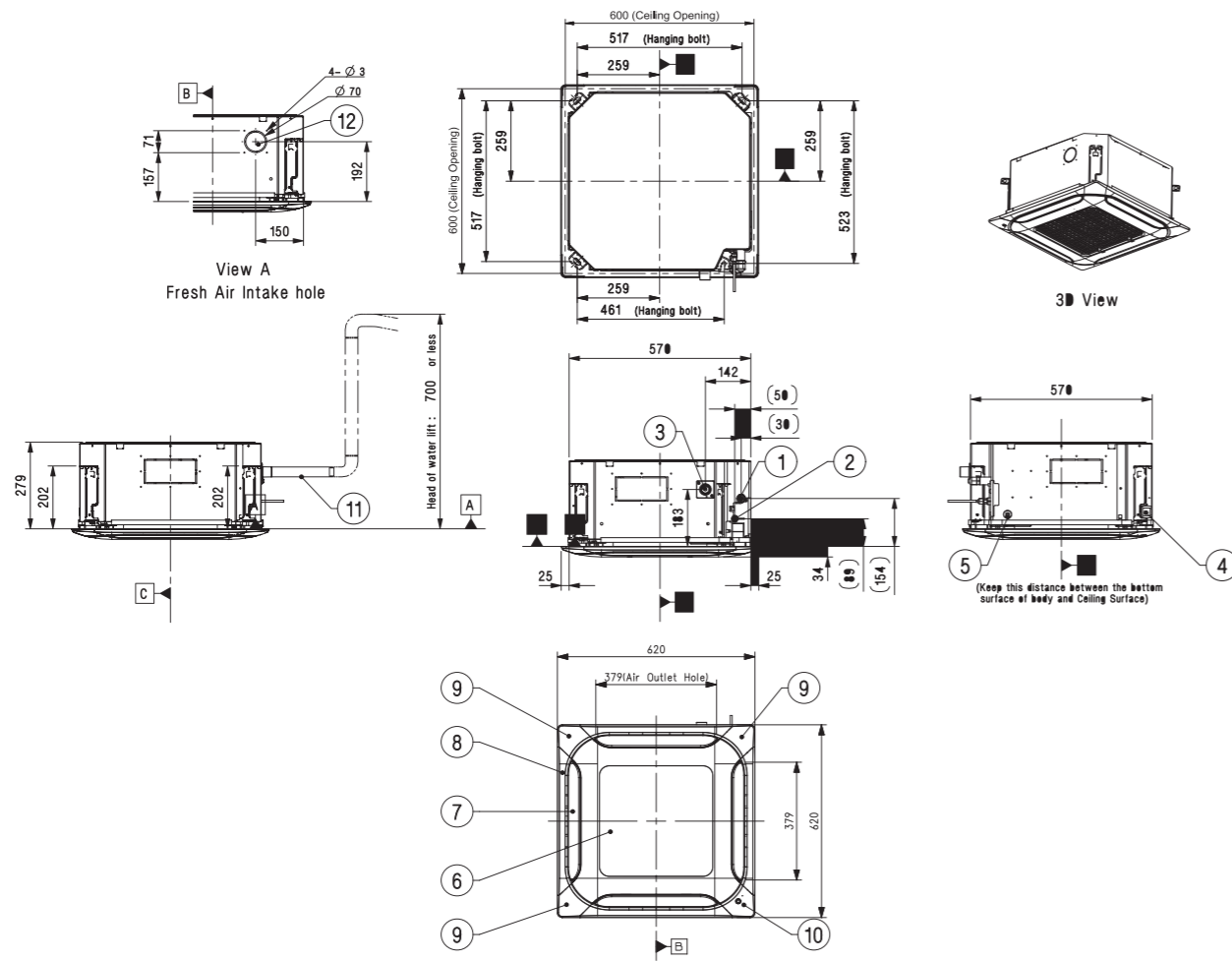

STANDARD / COMPACT INVERTER (R32)

CT24F NB0 / UT30F NB0

(Unit : mm)

PART NAME	
1	Gas Pipe Connection
2	Liquid Pipe Connection
3	Drain Pipe Connection
4	Power and Communication Cable Routing Hole
5	Wired Remote Controller Wire Routing Hole
6	Air Inlet
7	Air Outlet
8	Decoration Panel (Accessory)
9	Decoration Corner Cover
10	Flexible Drain Hose
11	Fresh Air Intake Hole

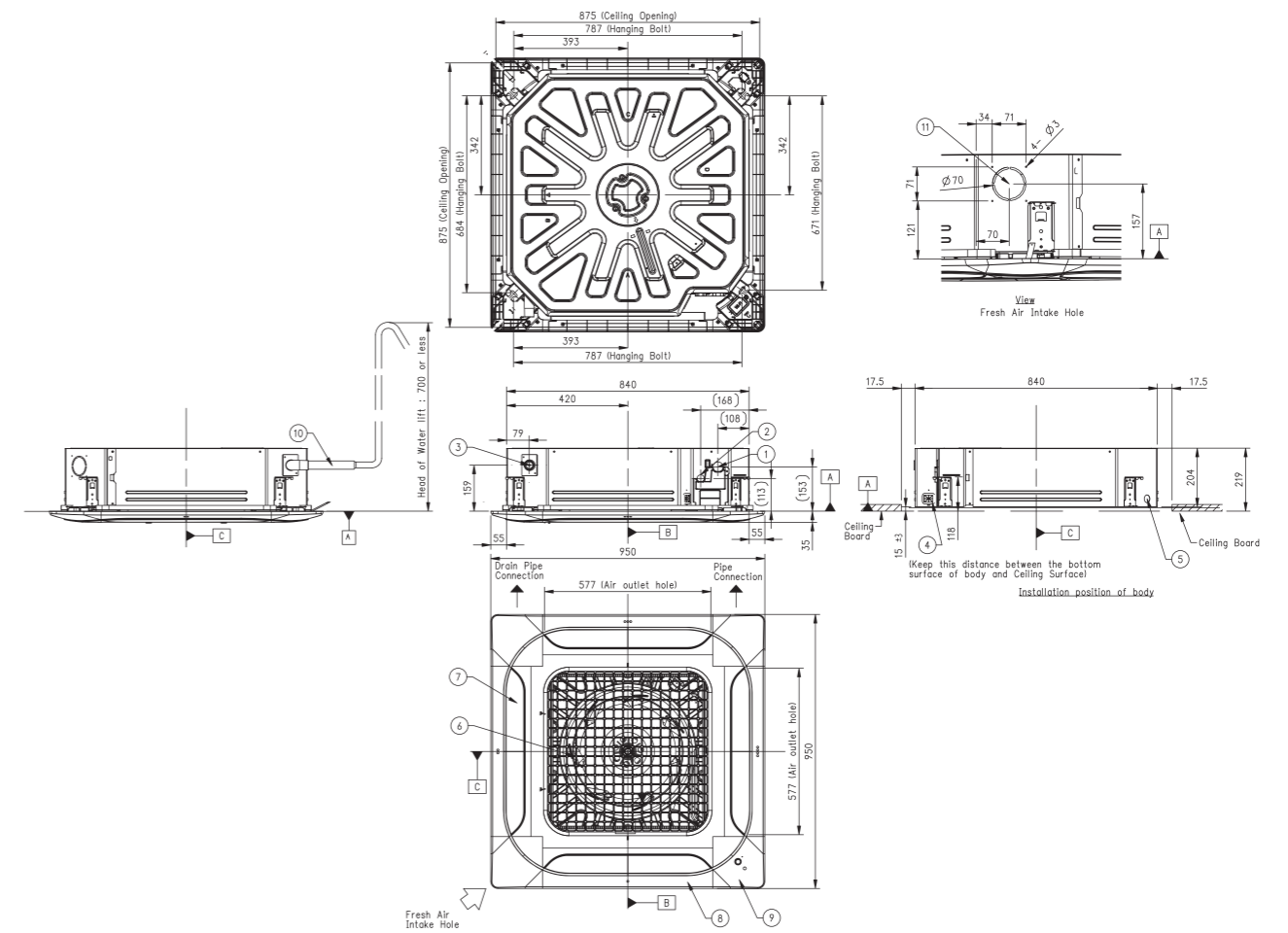

STANDARD / COMPACT INVERTER (R32)

UT36F NAO

(Unit : mm)

PART NAME	
1	Gas Pipe Connection
2	Liquid Pipe Connection
3	Drain Pipe Connection
4	Power and Communication Cable Routing Hole
5	Wired Remote Controller Wire Routing Hole
6	Air Inlet
7	Air Outlet
8	Decoration Panel (Accessory)
9	Decoration Corner Cover
10	Flexible Drain Hose
11	Fresh Air Intake Hole

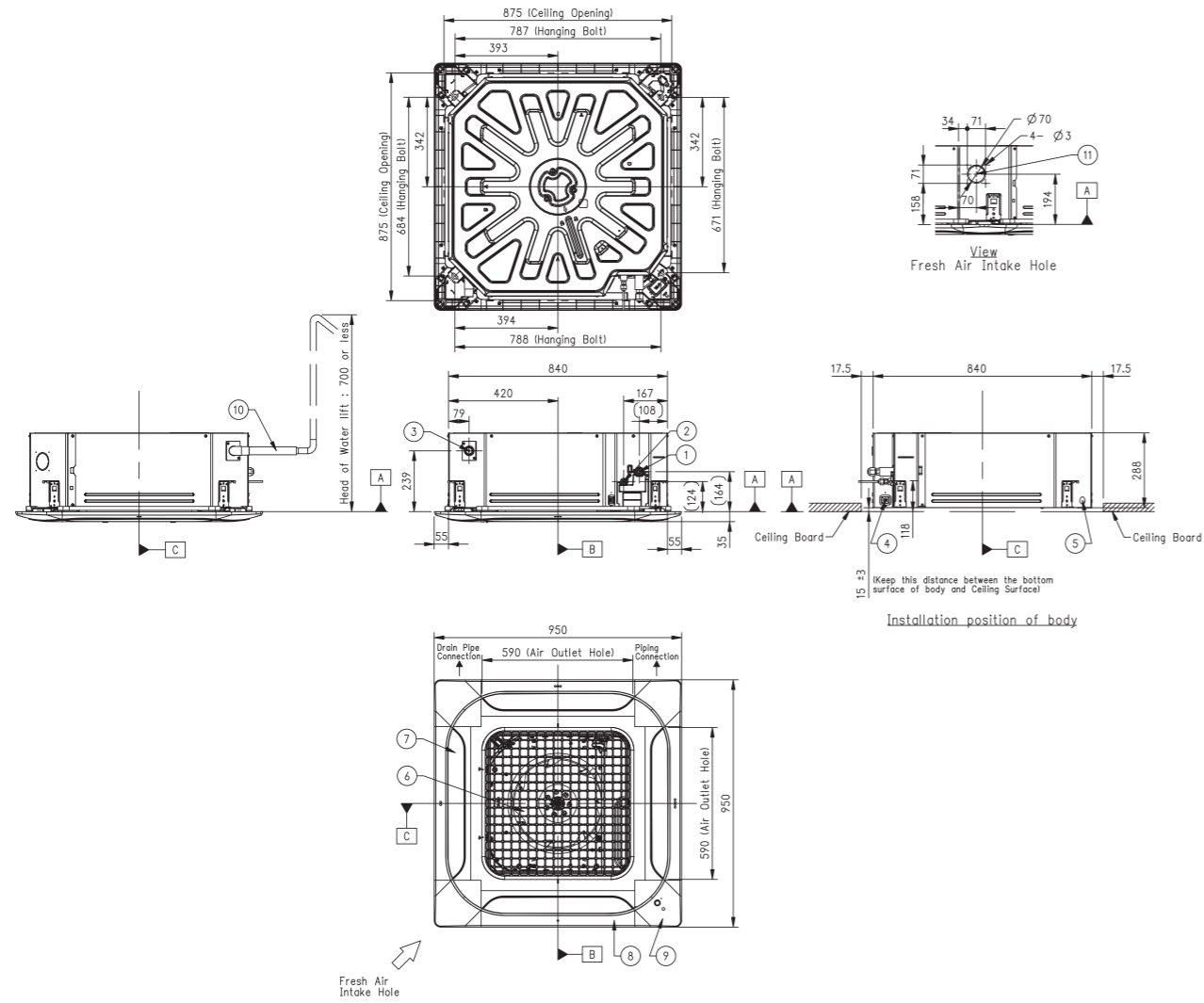

STANDARD INVERTER (R32)

UT42F NAO / UT48F NAO / UT60F NAO

(Unit : mm)

PART NAME	
1	Gas Pipe Connection
2	Liquid Pipe Connection
3	Drain Pipe Connection
4	Power and Communication Cable Routing Hole
5	Wired Remote Controller Wire Routing Hole
6	Air Inlet
7	Air Outlet
8	Decoration Panel (Accessory)
9	Decoration Corner Cover
10	Flexible Drain Hose
11	Fresh Air Intake Hole

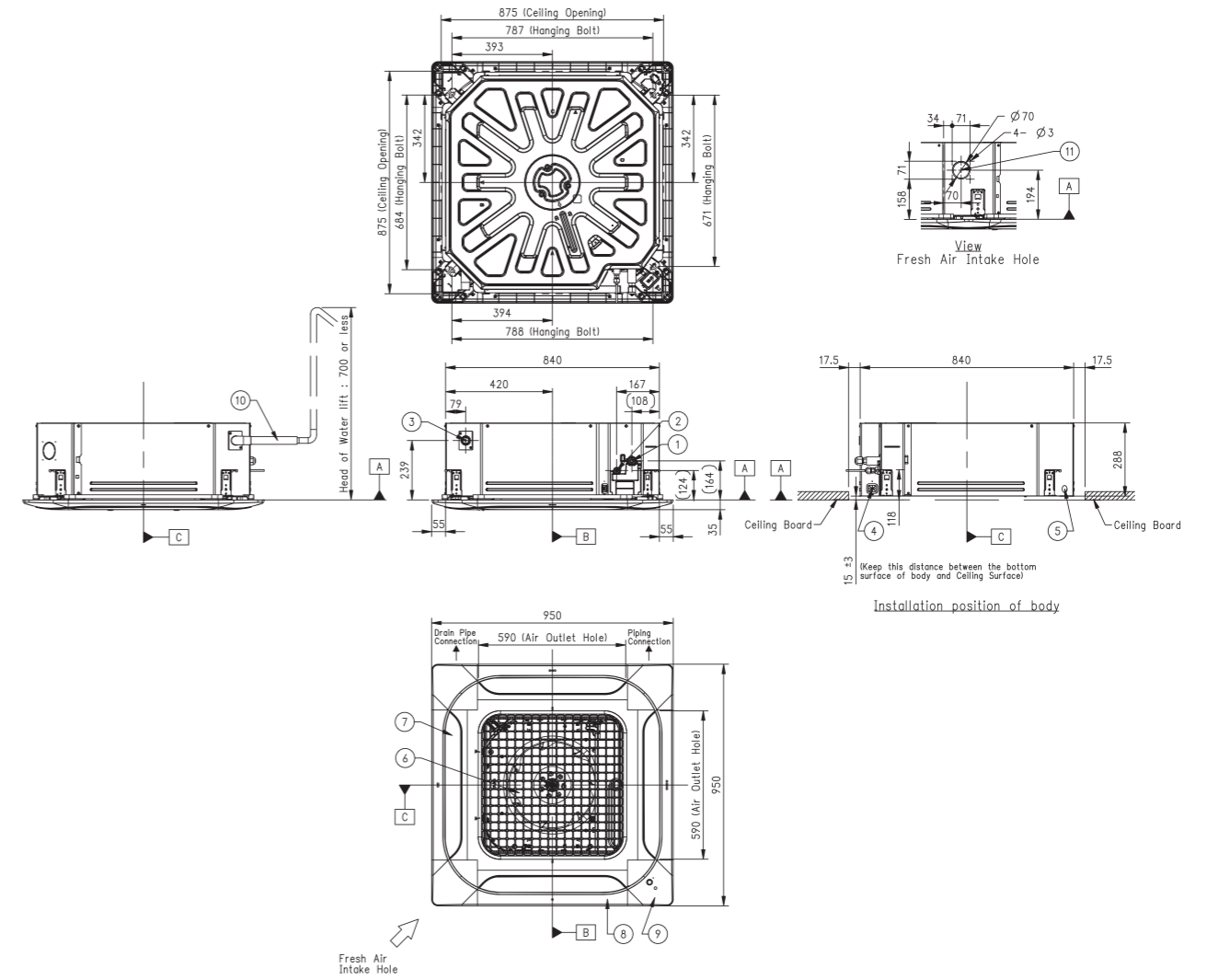

H-INVERTER (R32) / MID STATIC

UM12FH N10 / UM18FH N10

(Unit : mm)

PART NAME
1 Gas Pipe Connection
2 Liquid Pipe Connection
3 Drain Pipe Connection
4 Power and Communication Cable Routing Hole
5 Remote Controller Cable Hole
6 Air Inlet
7 Air Outlet
8 Air Filters
9 Control Cover

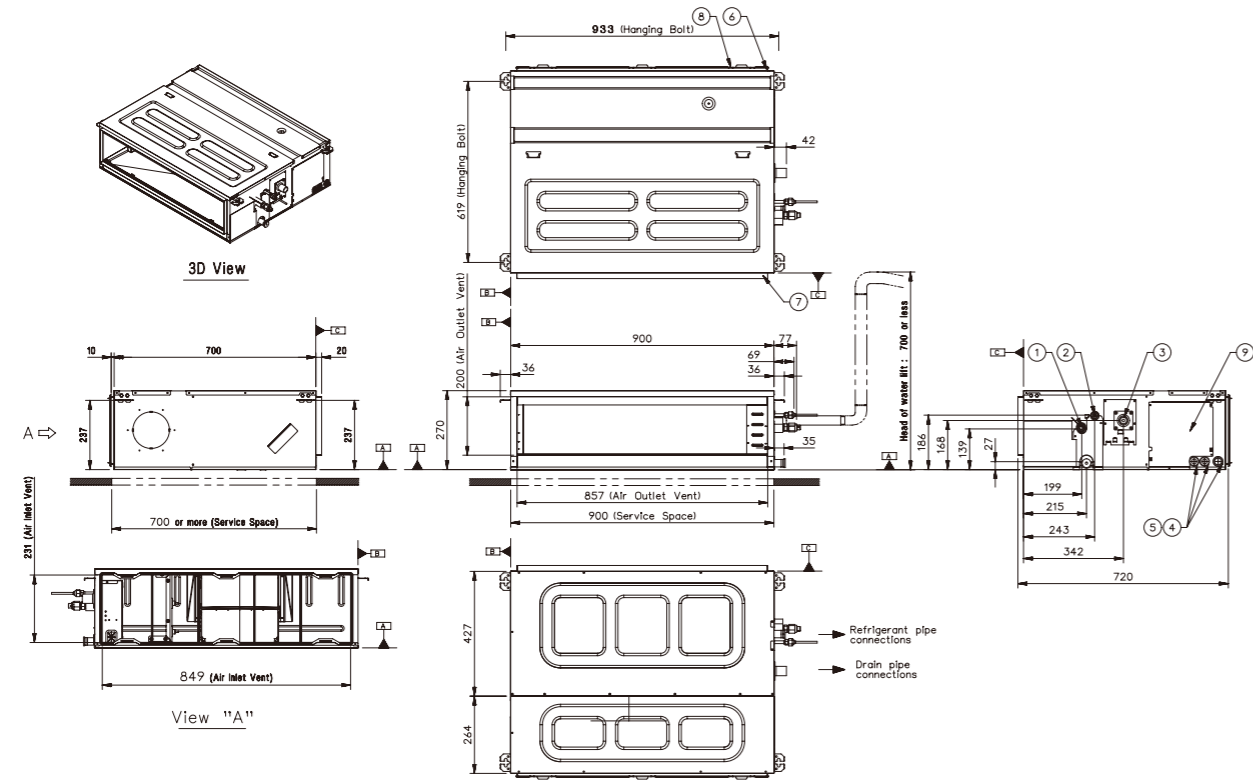

H-INVERTER (R32) / MID STATIC

UM24FH N20 / UM30FH N20

(Unit : mm)

PART NAME
1 Gas Pipe Connection
2 Liquid Pipe Connection
3 Drain Pipe Connection
4 Power and Communication Cable Routing Hole
5 Remote Controller Cable Hole
6 Air Inlet
7 Air Outlet
8 Air Filters
9 Control Cover

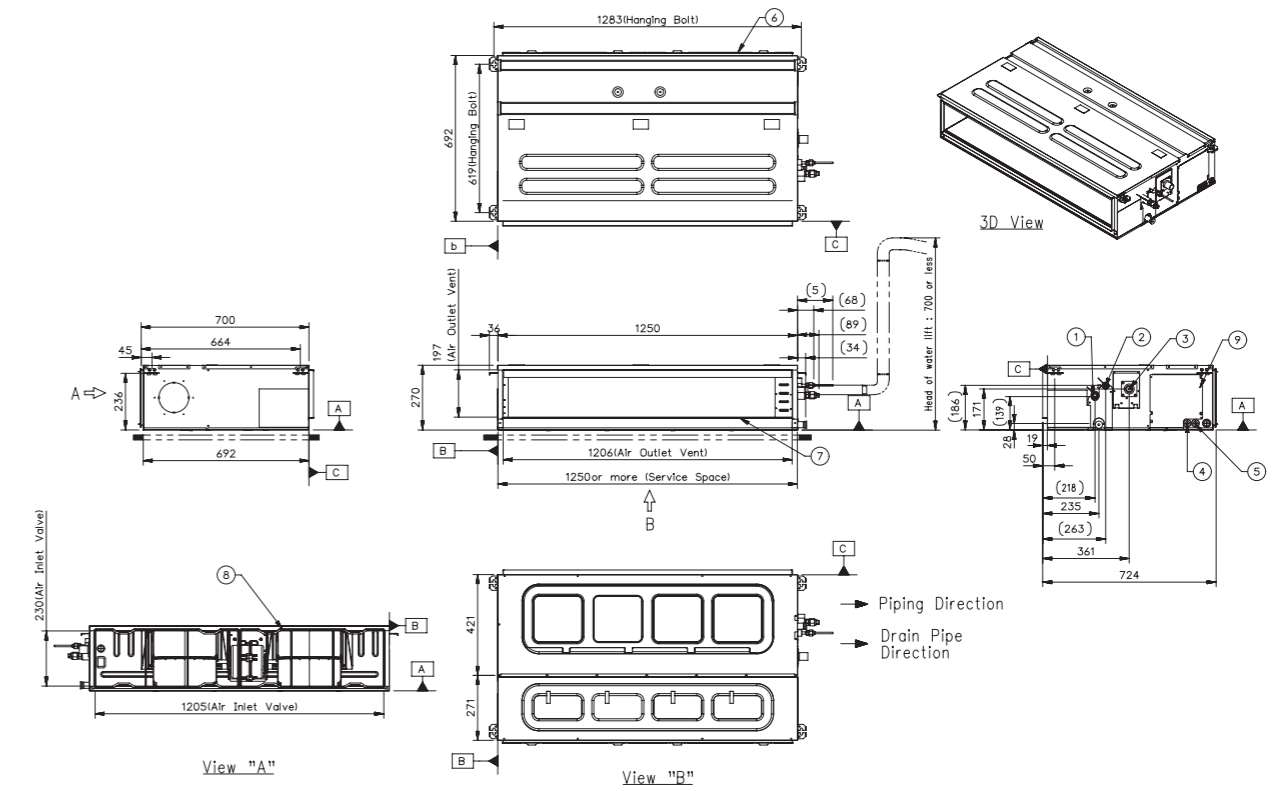

H-INVERTER (R32) / MID STATIC
UM36FH N30 / UM42FH N30 / UM48FH N30

(Unit : mm)

	PART NAME
1	Gas Pipe Connection
2	Liquid Pipe Connection
3	Drain Pipe Connection
4	Power and Communication Cable Routing Hole
5	Remote Controller Cable Hole
6	Air Inlet
7	Air Outlet
8	Air Filters
9	Control Cover

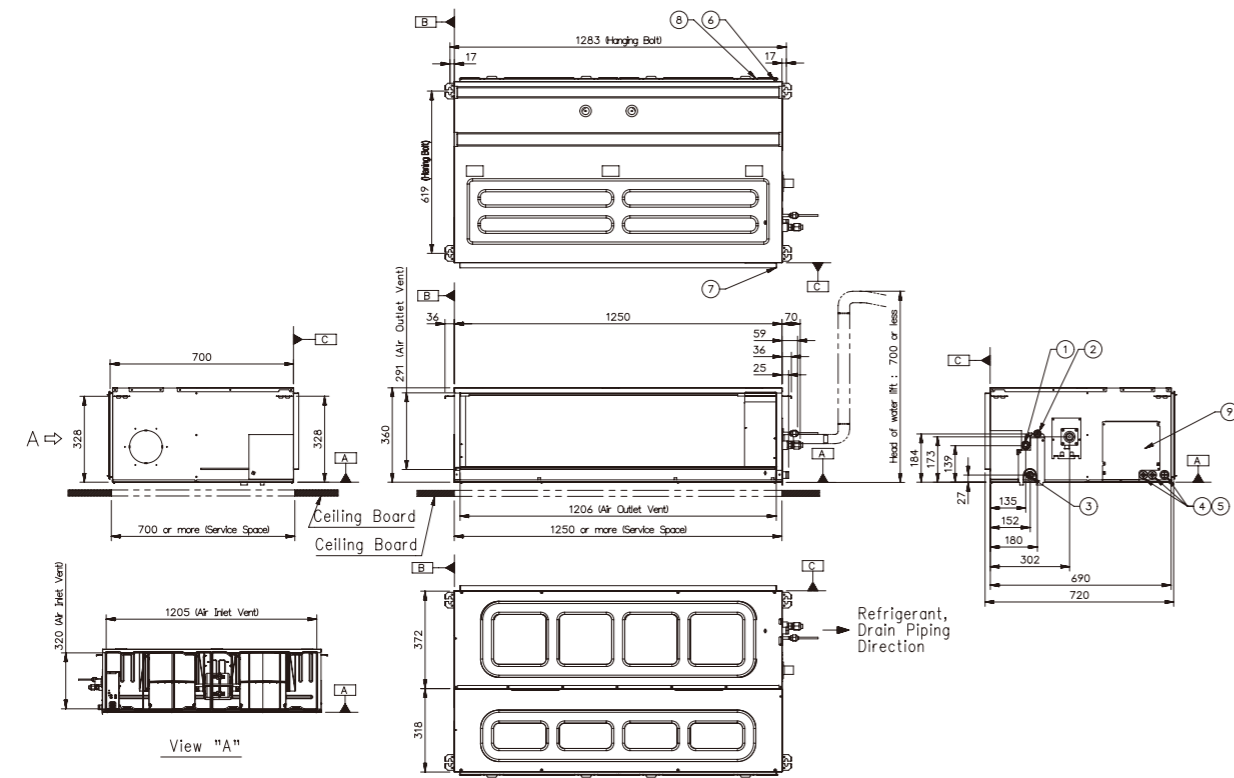

H-INVERTER (R32) / LOW STATIC
UL12FH N50

(Unit : mm)

	PART NAME
1	Liquid Pipe Connection
2	Gas Pipe Connection
3	Drain Pipe Connection
4	Power supply Connection
5	Air Discharge
6	Air Suction

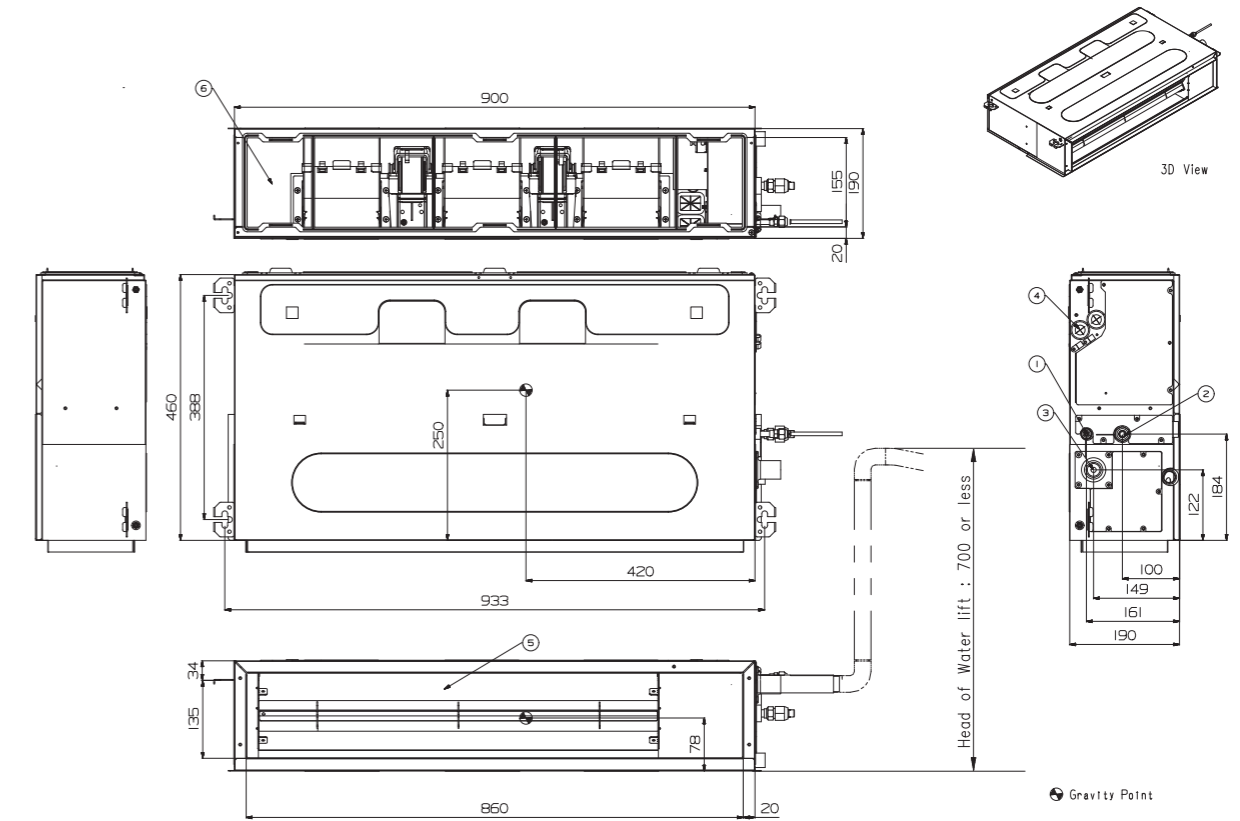

H-INVERTER (R32) / LOW STATIC

UL18FH N30

(Unit : mm)

PART NAME	
1	Liquid Pipe Connection
2	Gas Pipe Connection
3	Drain Pipe Connection
4	Power supply Connection
5	Air Discharge
6	Air Suction

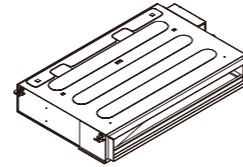
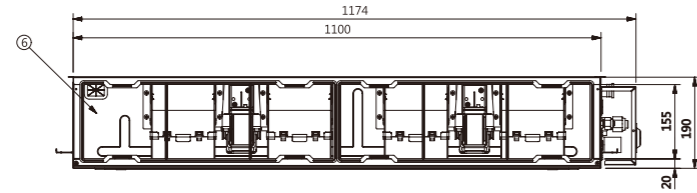

3D-VIEW

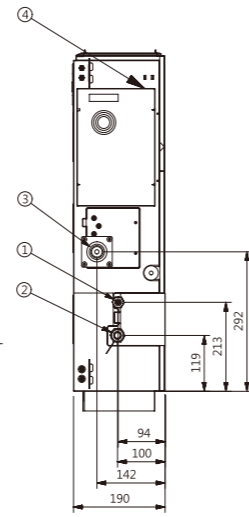
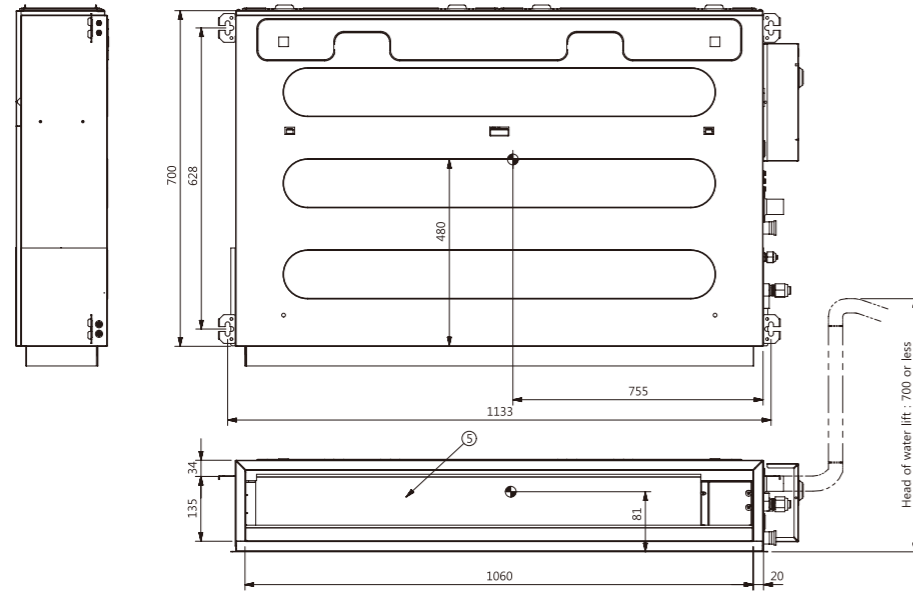

● Gravity point

STANDARD / COMPACT INVERTER (R32) / MID STATIC

CM18F N10 / CM24F N10 / UM30F N10

(Unit : mm)

PART NAME	
1	Gas Pipe Connection
2	Liquid Pipe Connection
3	Drain Pipe Connection
4	Power and Communication Cable Hole
5	Remote Controller Cable Hole
6	Air Inlet
7	Air Outlet
8	Air Filters
9	Control Cover

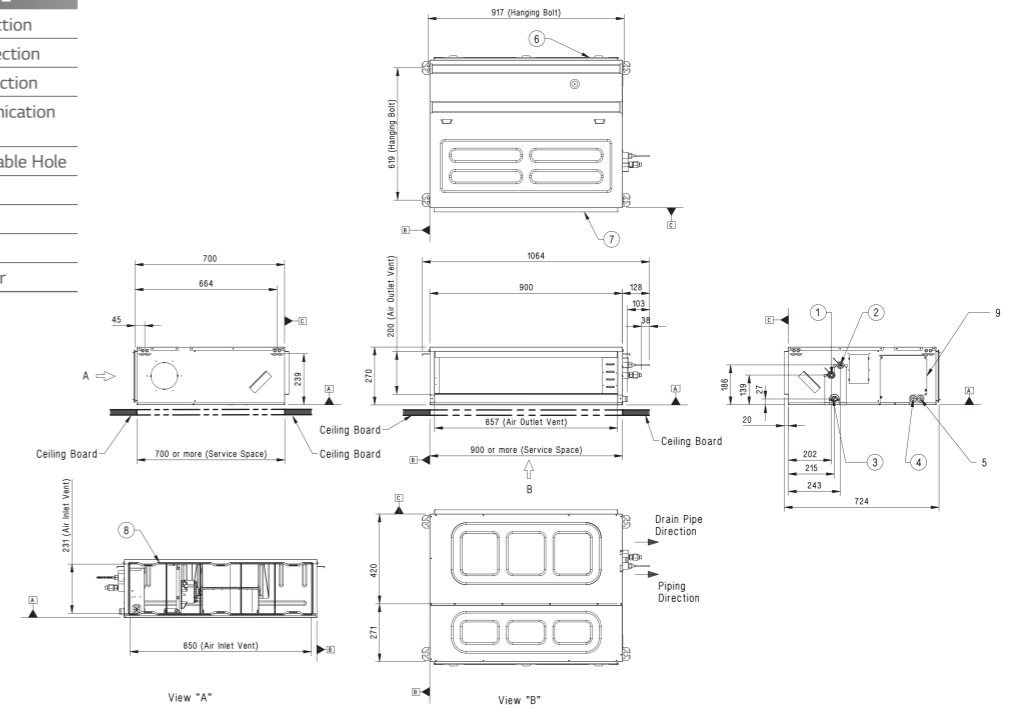

STANDARD / COMPACT INVERTER (R32) / MID STATIC

UM36F N20

(Unit : mm)

PART NAME	
1	Gas Pipe Connection
2	Liquid Pipe Connection
3	Drain Pipe Connection
4	Power and Communication Cable Hole
5	Remote Controller Cable Hole
6	Air Inlet
7	Air Outlet
8	Air Filters
9	Control Cover

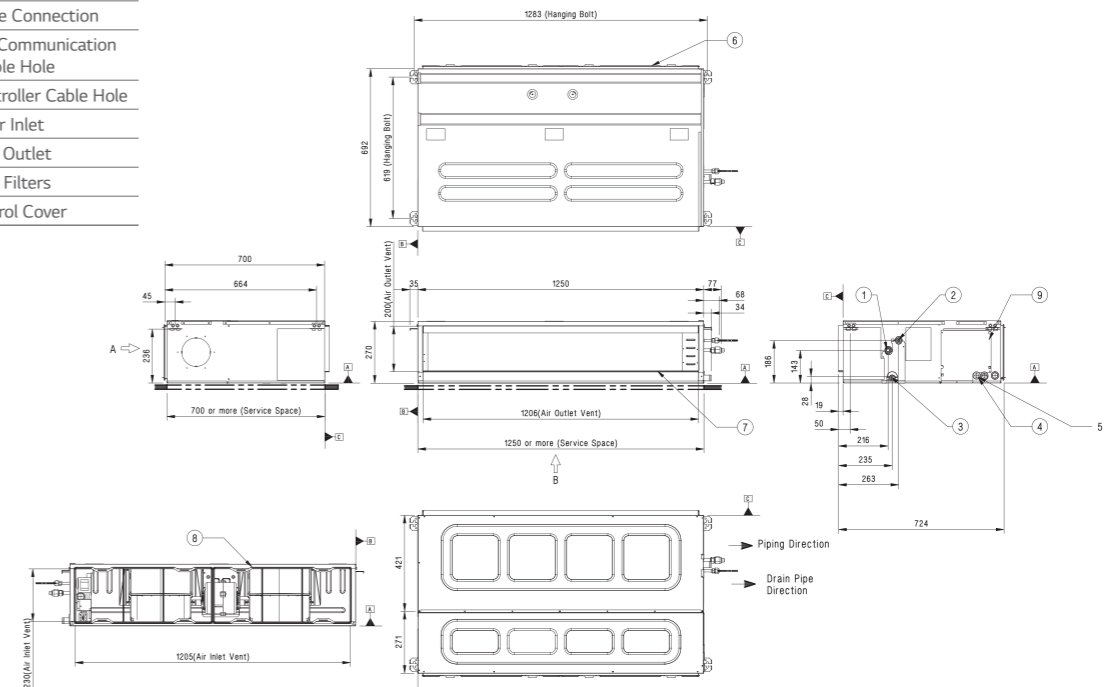

STANDARD INVERTER (R32) / MID STATIC

UM42F N20

(Unit : mm)

PART NAME
1 Gas Pipe Connection
2 Liquid Pipe Connection
3 Drain Pipe Connection
4 Power and Communication Cable Hole
5 Remote Controller Cable Hole
6 Air Inlet
7 Air Outlet
8 Air Filters
9 Control Cover

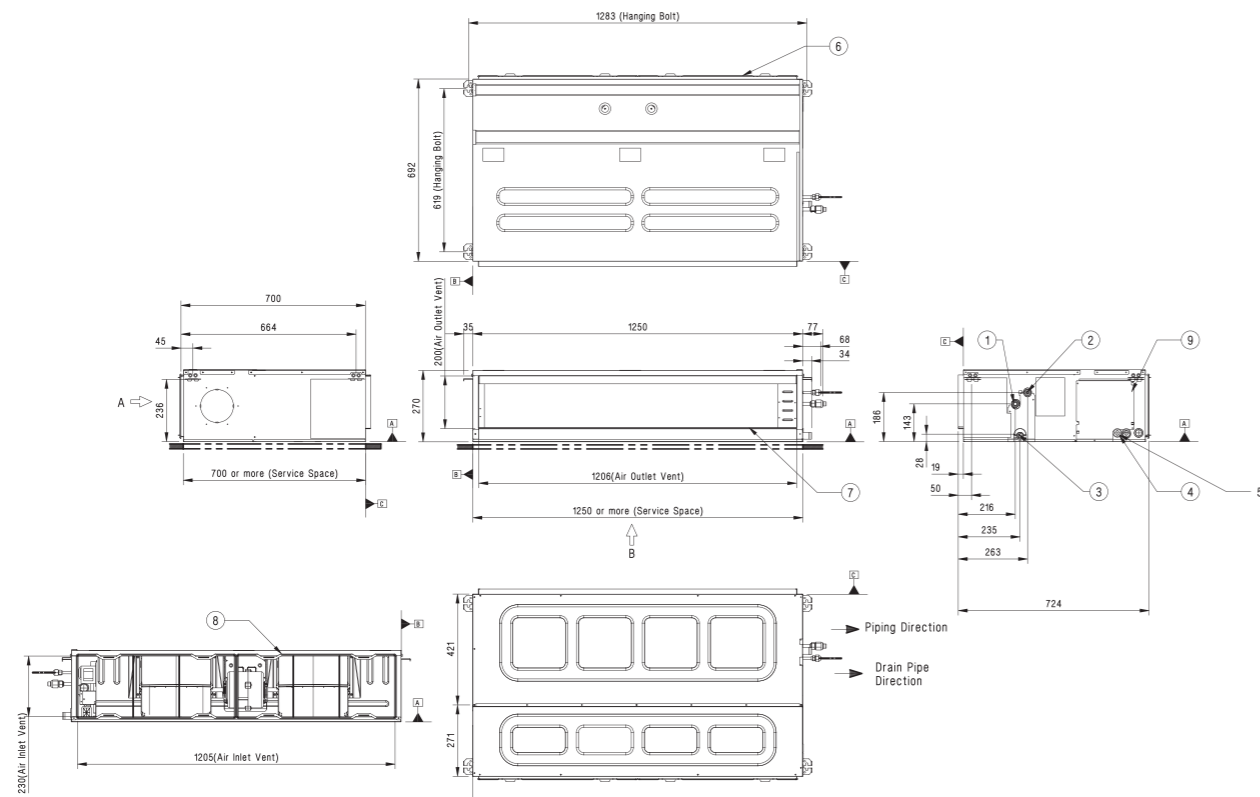

STANDARD INVERTER (R32) / MID STATIC

UM48F N30 / UM60F N30

(Unit : mm)

PART NAME
1 Gas Pipe Connection
2 Liquid Pipe Connection
3 Drain Pipe Connection
4 Power and Communication Cable Hole
5 Remote Controller Cable Hole
6 Air Inlet
7 Air Outlet
8 Air Filters
9 Control Cover

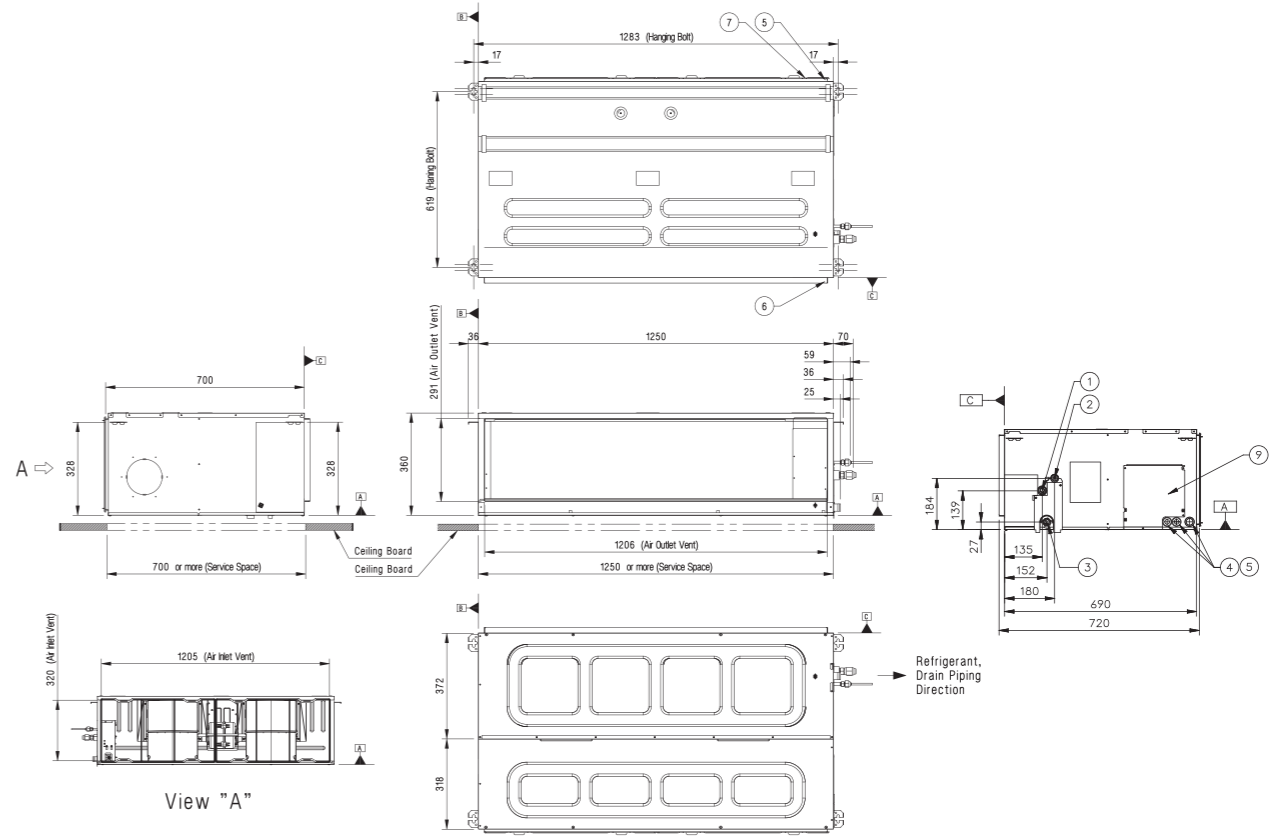

STANDARD INVERTER (R32) / LOW STATIC

CL09F N50 / CL12F N50

(Unit : mm)

	PART NAME
1	Liquid Pipe Connection
2	Gas Pipe Connection
3	Drain Pipe Connection
4	Power Supply Connection
5	Air Discharge
6	Air Suction

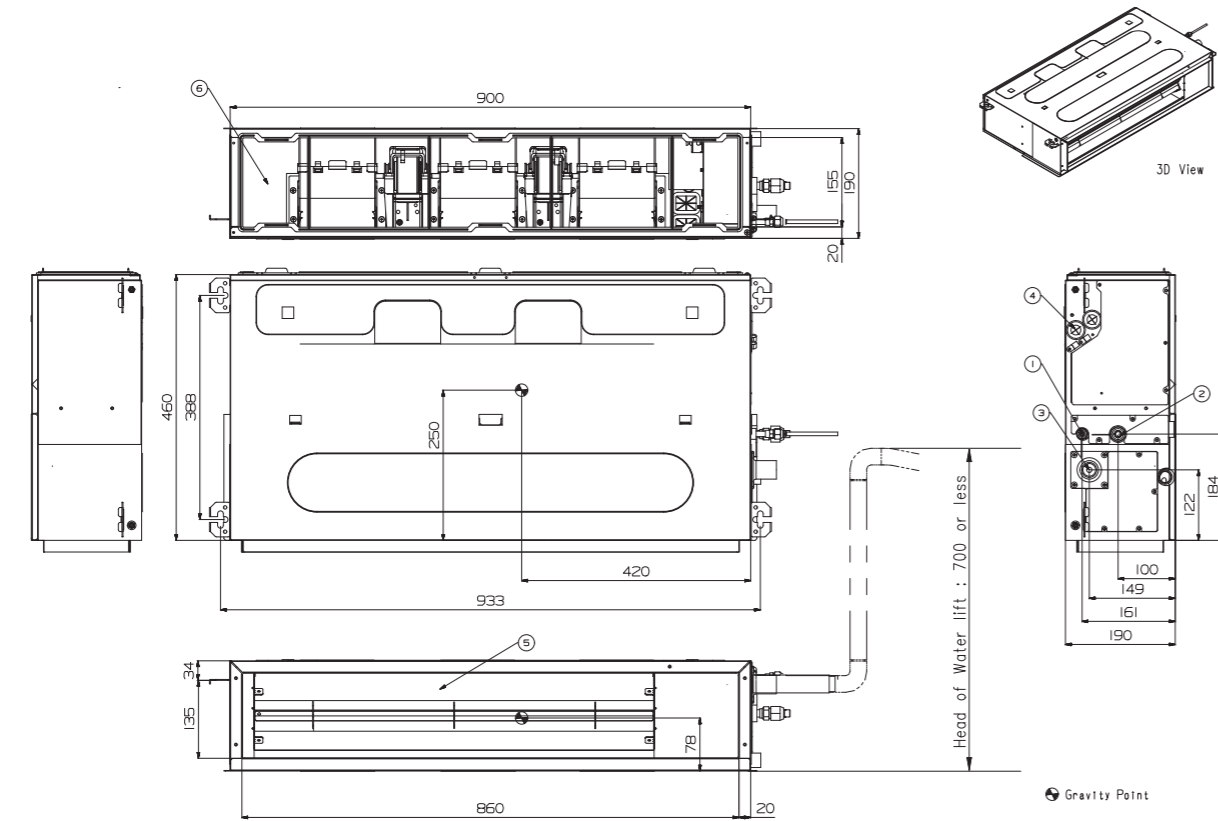

STANDARD / COMPACT INVERTER (R32) / LOW STATIC

CL18F N60

(Unit : mm)

	PART NAME
1	Liquid Pipe Connection
2	Gas Pipe Connection
3	Drain Pipe Connection
4	Power Supply Connection
5	Air Discharge
6	Air Suction

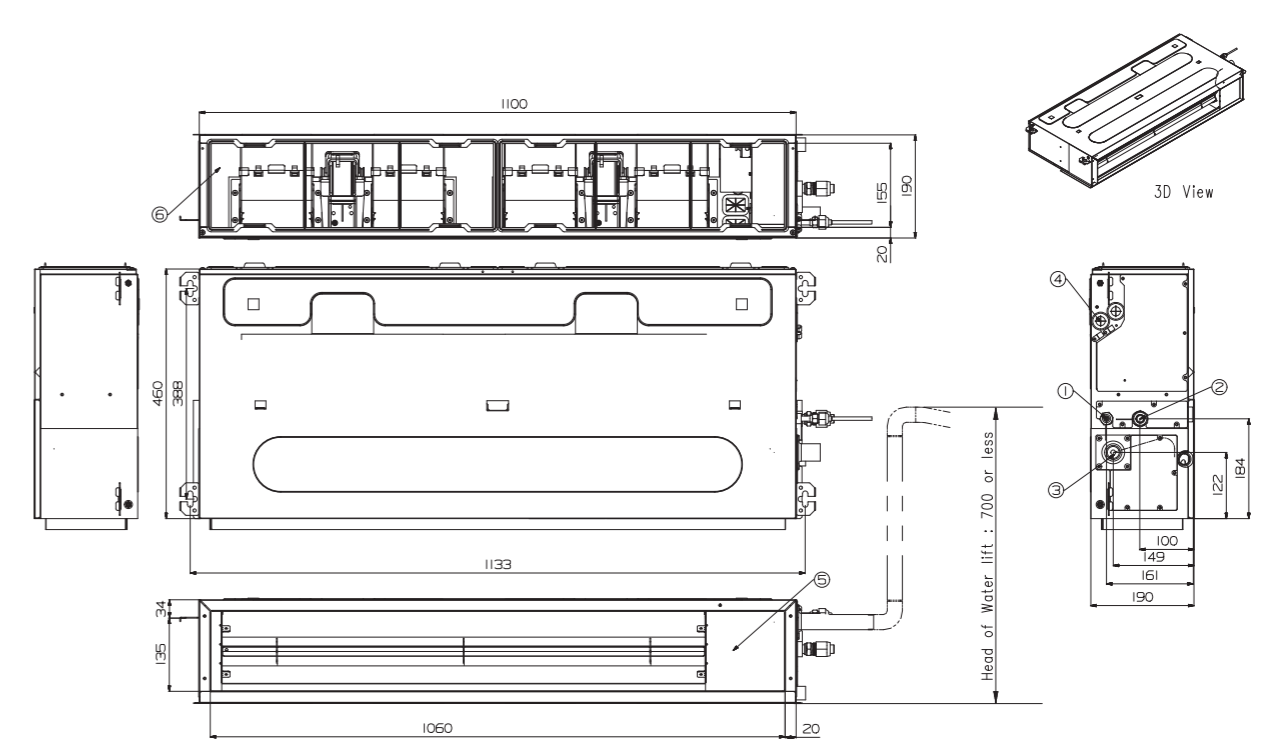

STANDARD / COMPACT INVERTER (R32) / LOW STATIC

CL24F N30

(Unit : mm)

PART NAME	
1	Liquid Pipe Connection
2	Gas Pipe Connection
3	Drain Pipe Connection
4	Power Supply Connection
5	Air Discharge
6	Air Suction

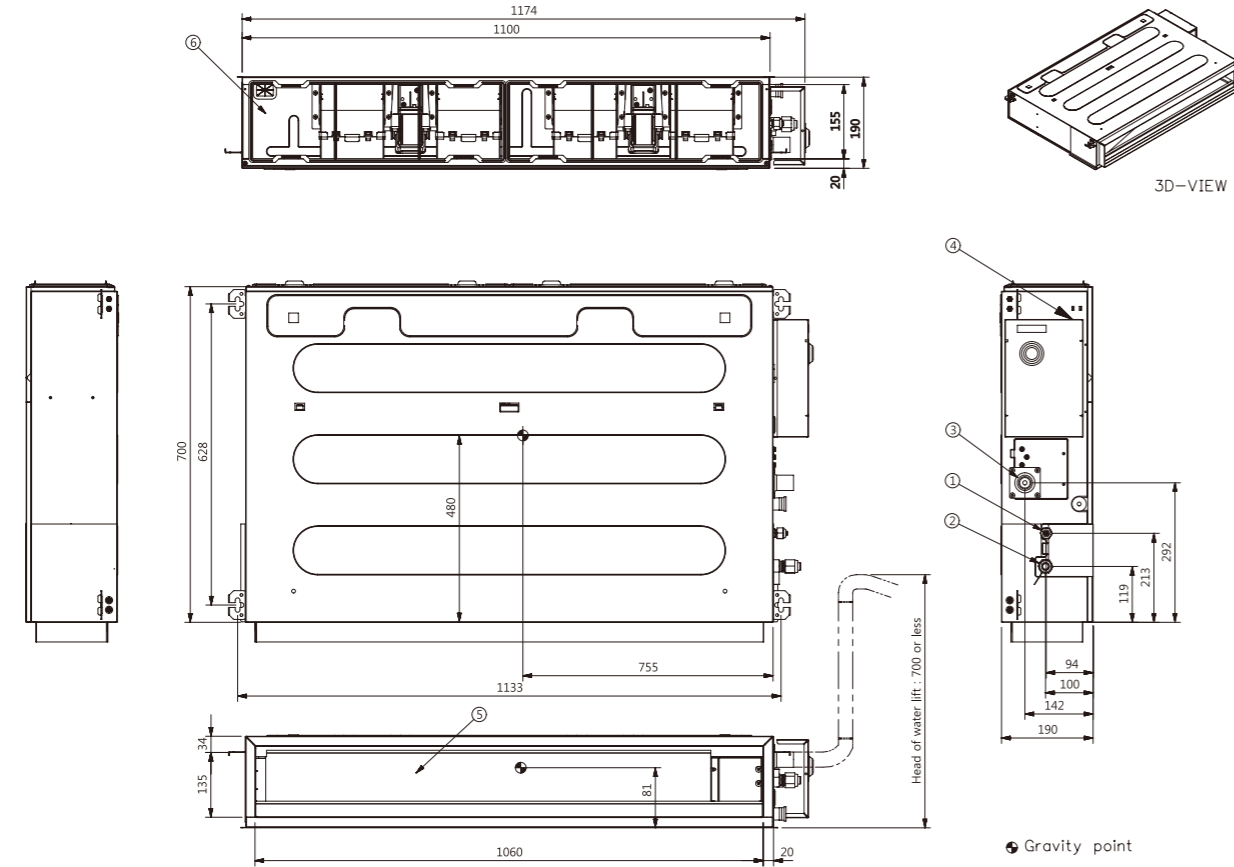

STANDARD INVERTER (R410A) / HIGH STATIC

UB70 N94 / UB85 N94

(Unit : mm)

PART NAME	
1	Air Suction Flange
2	Air Discharge Flange
3	Control Box
4	Gas Piping Connection
5	Liquid Pipe Connection
6	Drain Pipe Connection
7	Drain Pump (Option)

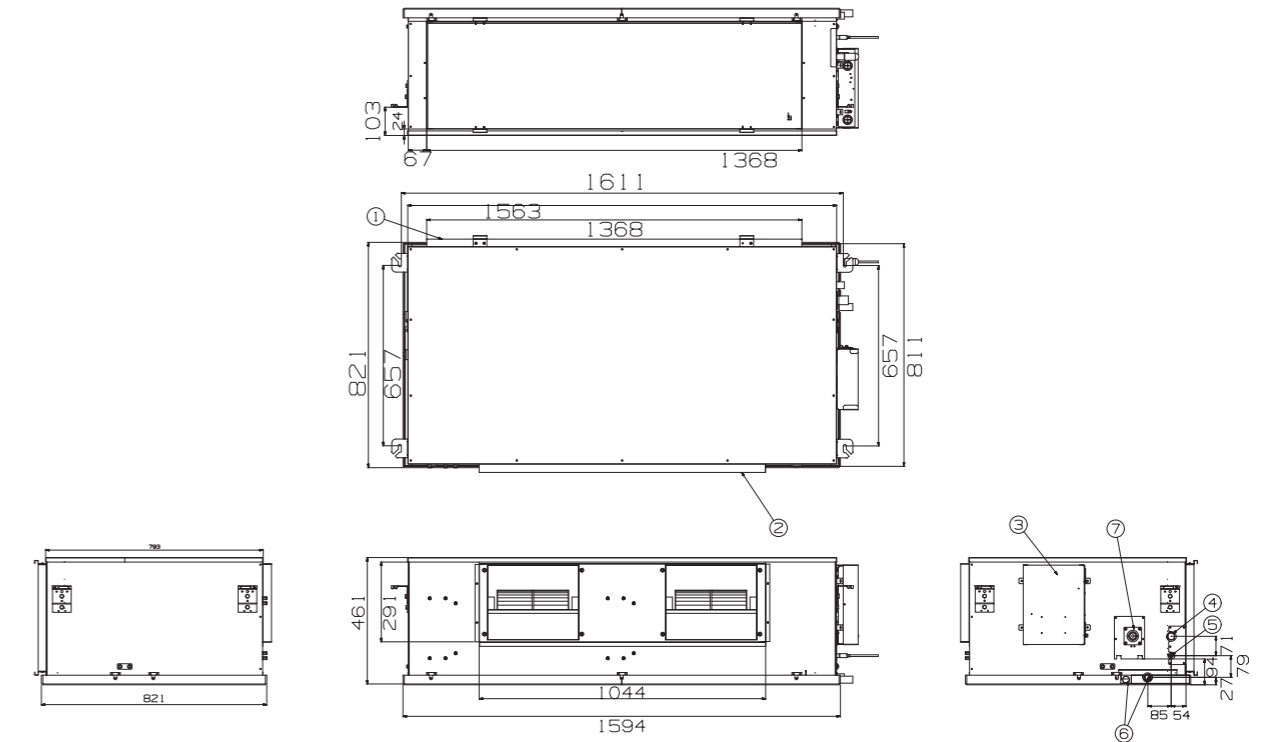

H-INVERTER (R32)

UV18FH N10

(Unit : mm)

PART NAME	
1	Air Inlet
2	Air Outlet
3	Remote Controller Signal Receiver
4	Drain Hose Routing Hole
5	Refrigerant Pipe and Routing Hole
6	Gas Pipe Connection
7	Liquid Pipe Connection

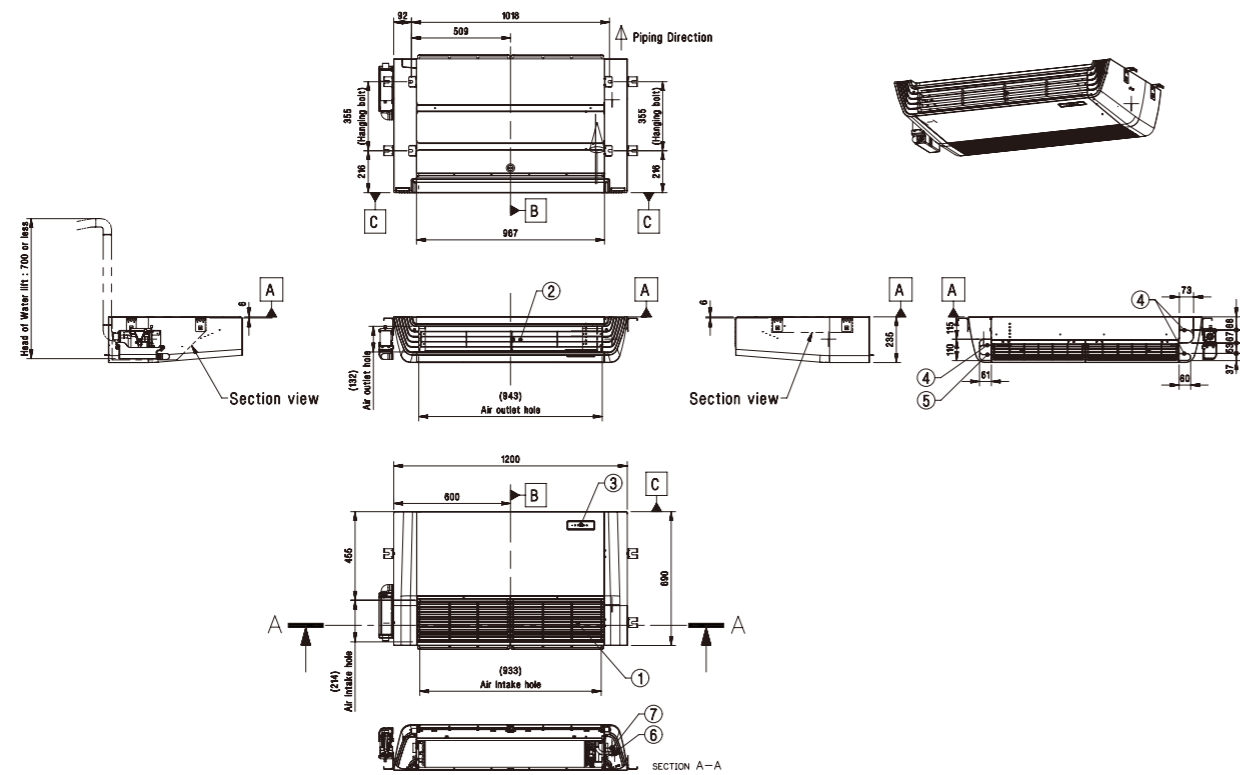

H-INVERTER (R32)

UV24FH N20 / UV30FH N20 / UV36FH N20 / UV42FH N20

(Unit : mm)

PART NAME	
1	Air Inlet
2	Air Outlet
3	Remote Controller Signal Receiver
4	Drain Hose Routing Hole
5	Refrigerant Pipe and Routing Hole
6	Gas Pipe Connection
7	Liquid Pipe Connection

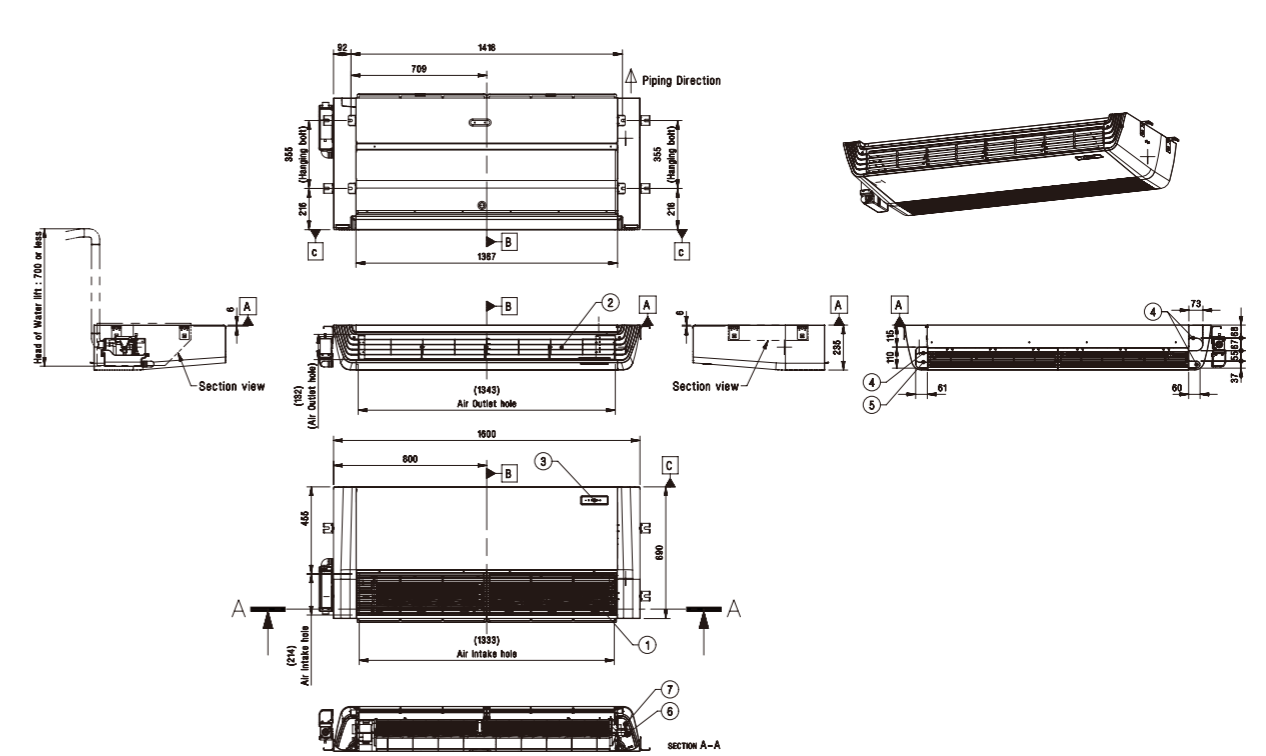

STANDARD / COMPACT INVERTER (R32)
UV18F N10 / UV24F N10 / UV30F N10

(Unit : mm)

PART NAME	
1	Air Inlet
2	Air Outlet
3	Remote Controller Signal Receiver
4	Drain Hose Routing Hole
5	Refrigerant Pipe and Routing Hole
6	Gas Pipe Connection
7	Liquid Pipe Connection

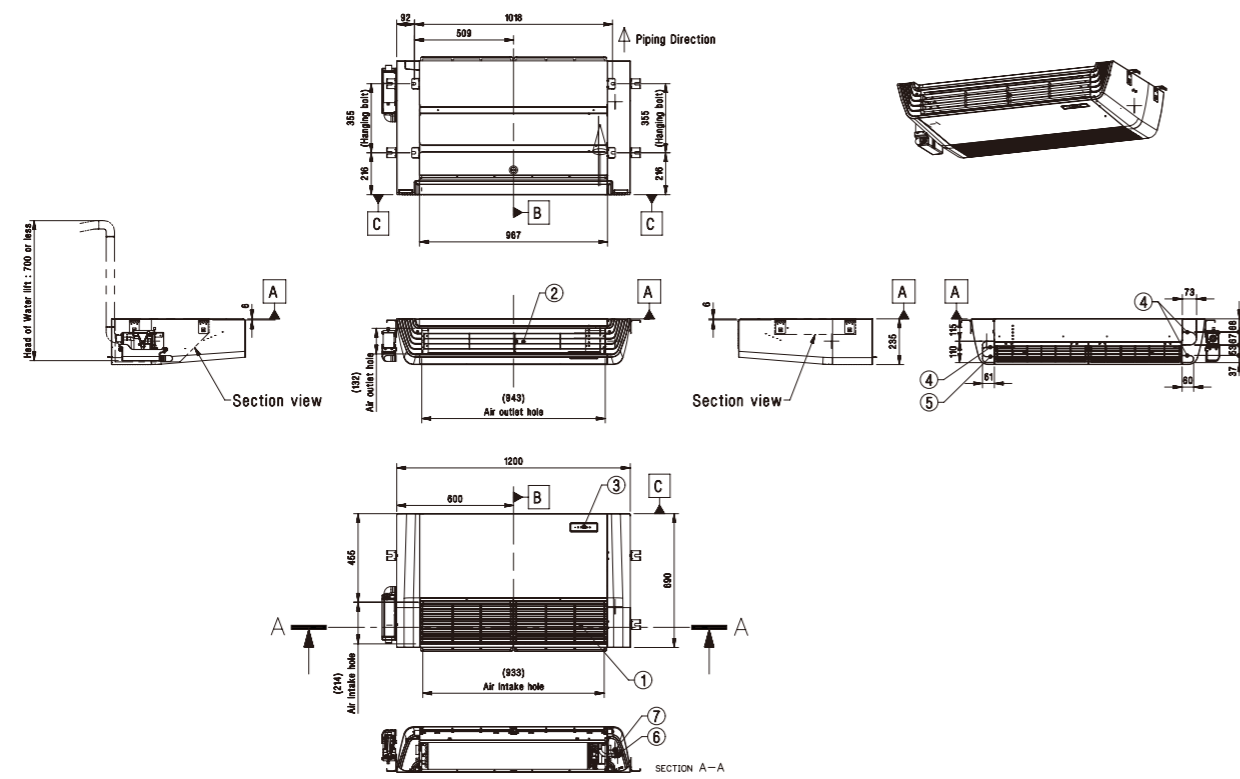

STANDARD INVERTER (R32)
UV36F N20 / UV42F N20 / UV48F N20 / UV60F N20

(Unit : mm)

PART NAME	
1	Air Inlet
2	Air Outlet
3	Remote Controller Signal Receiver
4	Drain Hose Routing Hole
5	Refrigerant Pipe and Routing Hole
6	Gas Pipe Connection
7	Liquid Pipe Connection

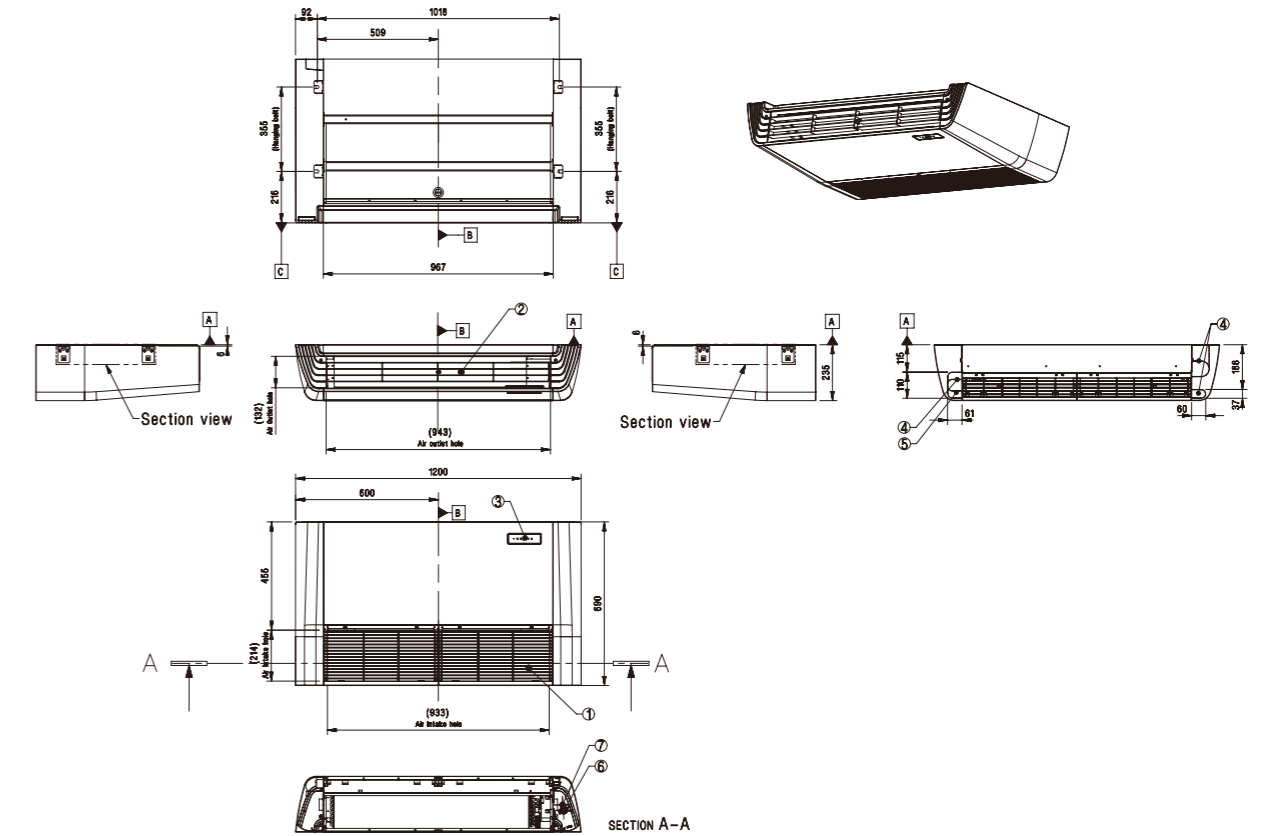

STANDARD INVERTER (R32)
UQ09 NA0 / UQ12 NA0 / UQ18 NA0

(Unit : mm)

PART NAME
1 Air Suction Grille
2 Remote Controller Signal Receiver
3 Air Discharge Grille
4 Gas Pipe Connection
5 Liquid Pipe Connection
6 Drain Hose Connection
7 Refrigerant / Drain Pipe & Cable Routing Hole
8 Installation Plate
9 Terminal Block for Power Supply & Communication

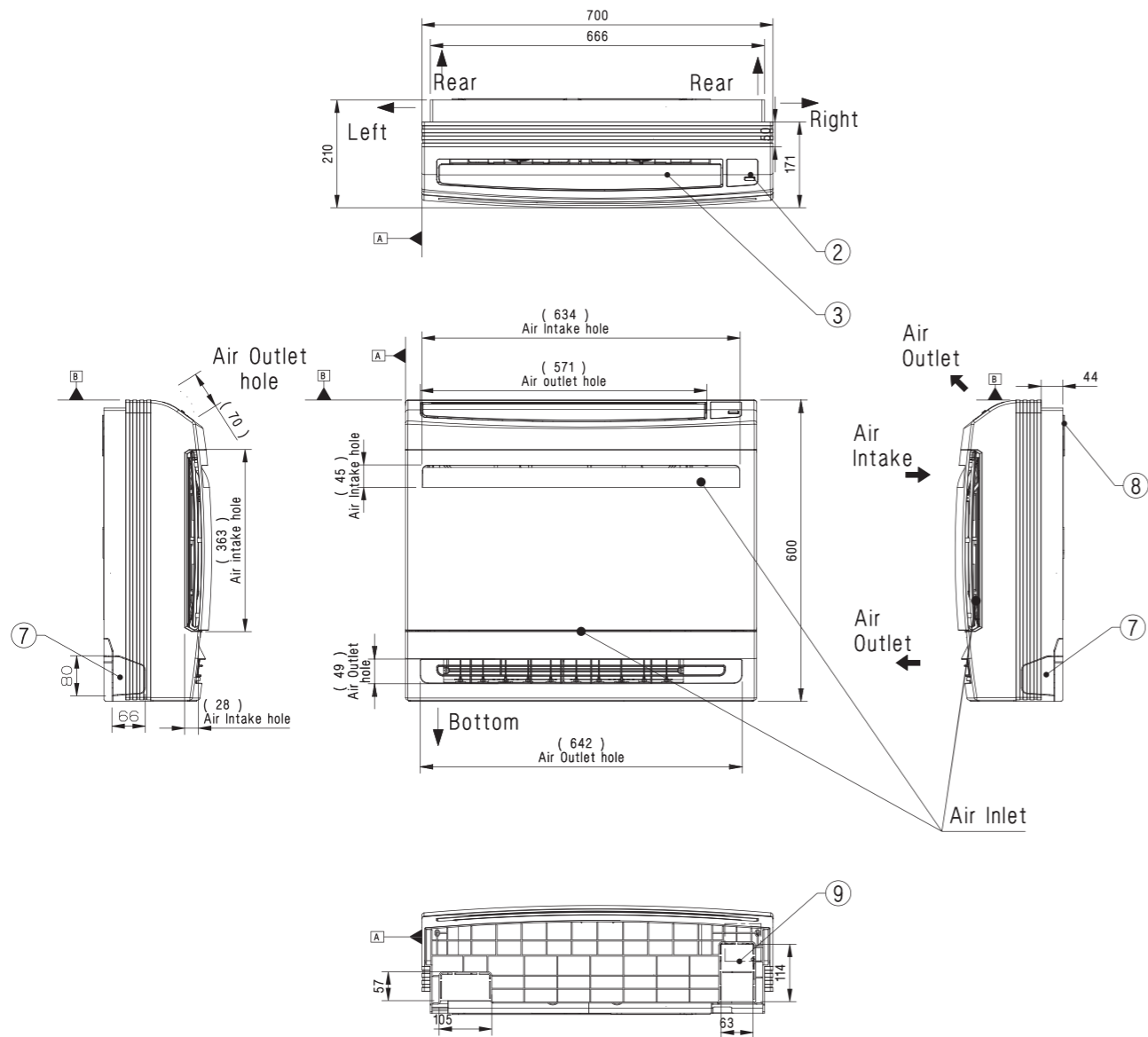

STANDARD INVERTER (R32)
MJ09PC NSJ / MJ12PC NSJ

(Unit : mm)

PART NAME
1 Refrigerant / Drain Pipe and Cable Routing Hole
2 Installation Plate
3 Drain Hose Connection
4 Terminal Block for Power Supply Communication
5 Display & Remote Controller Signal Receiver
6 Decoration Cover

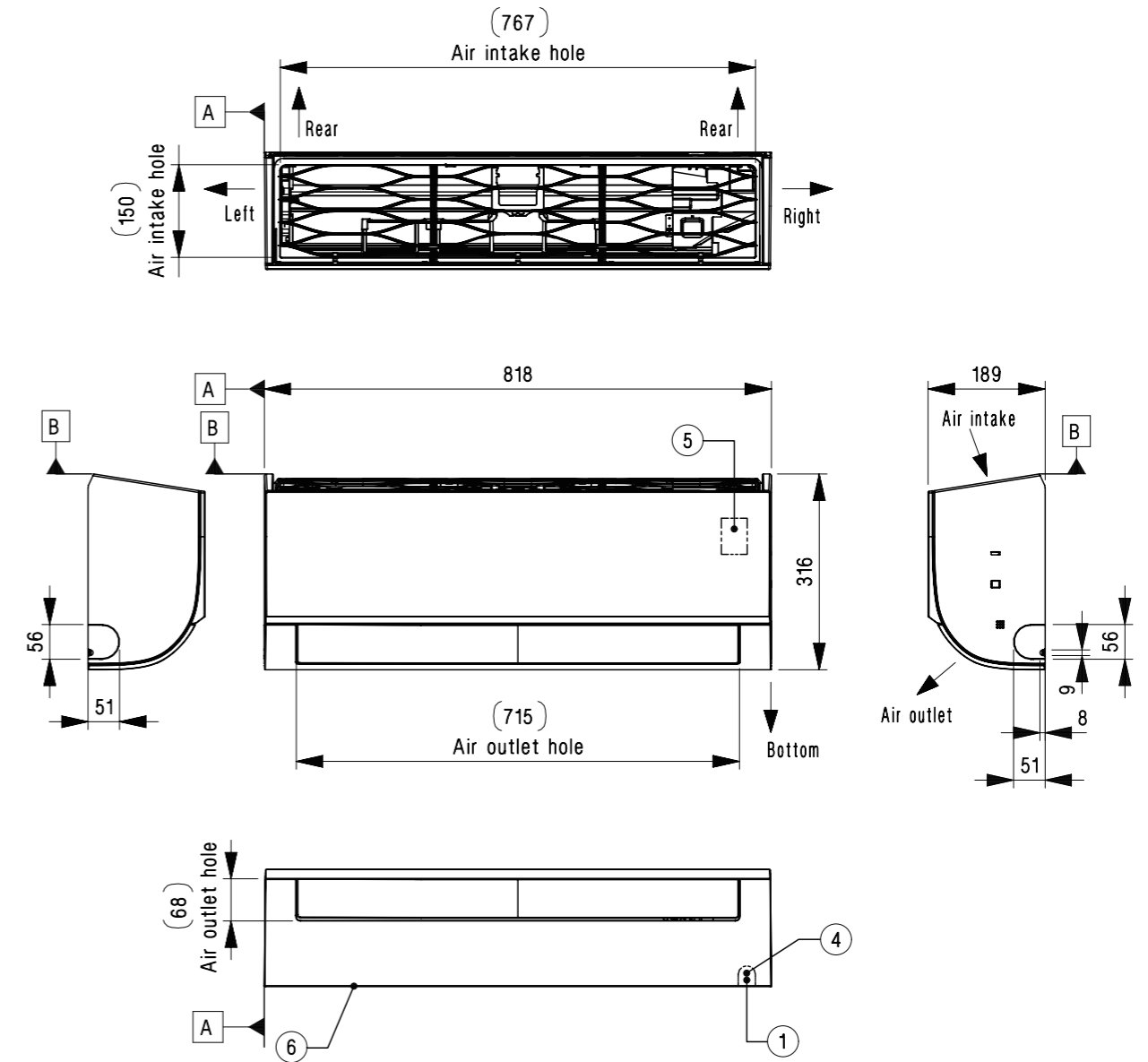

STANDARD INVERTER (R32)
MJ18PC NSJ / MJ24PC NSJ

(Unit : mm)

	PART NAME
1	Refrigerant / Drain Pipe and Cabel Routing Hole
2	Installation Plate
3	Drain Hose Connection
4	Terminal Block for Power Supply Communication
5	Display & Remote Controller Signal Receiver
6	Decoration Cover

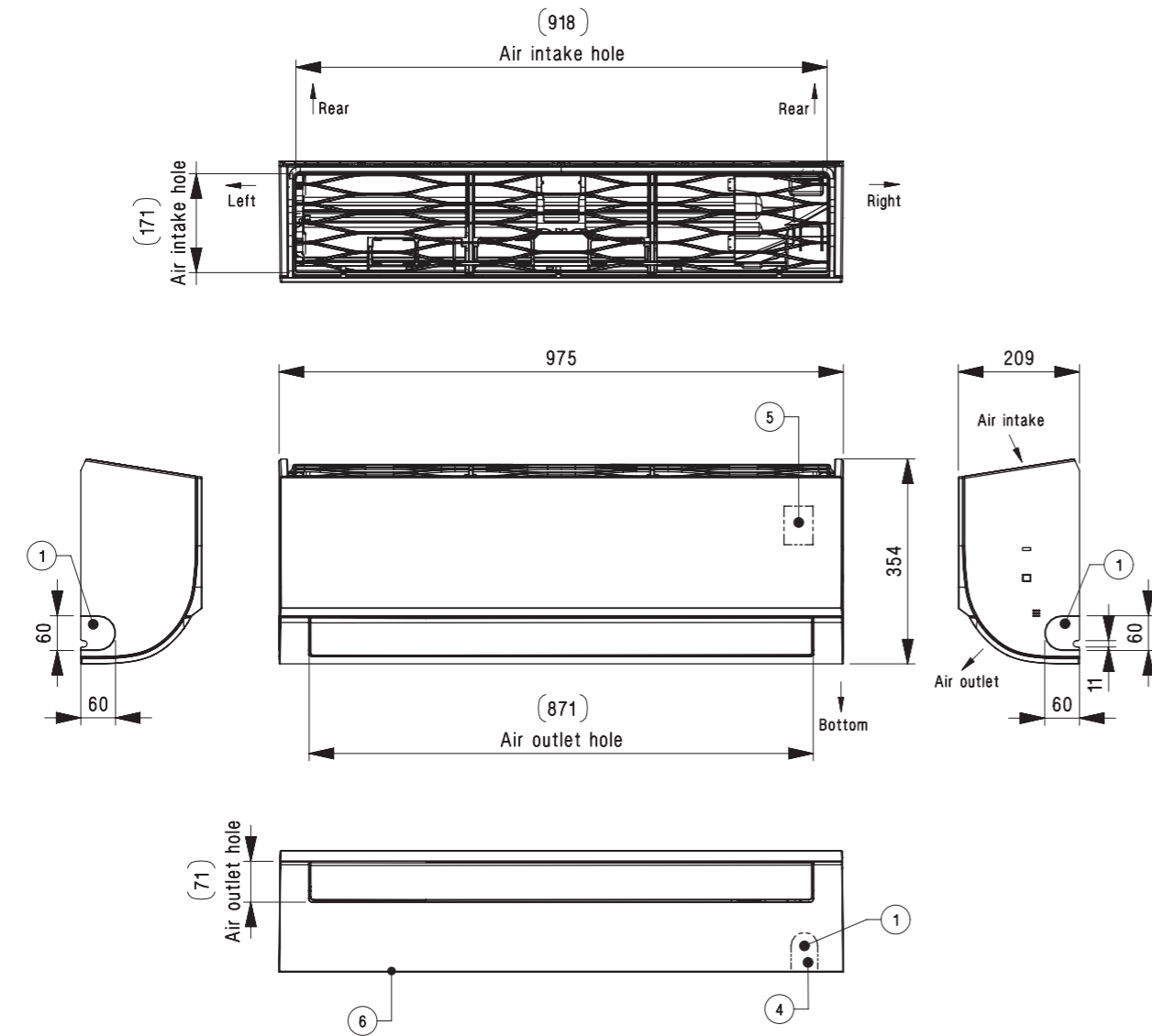

STANDARD / COMPACT INVERTER (R32)
US30F NR0 / US36F NR0

(Unit : mm)

	PART NAME
1	Refrigerant / Drain Pipe and Cabel Routing Hole
2	Installation Plate
3	Drain Hose Connection
4	Terminal Block for Power Supply Communication
5	Display & Remote Controller Signal Receiver
6	Decoration Cover

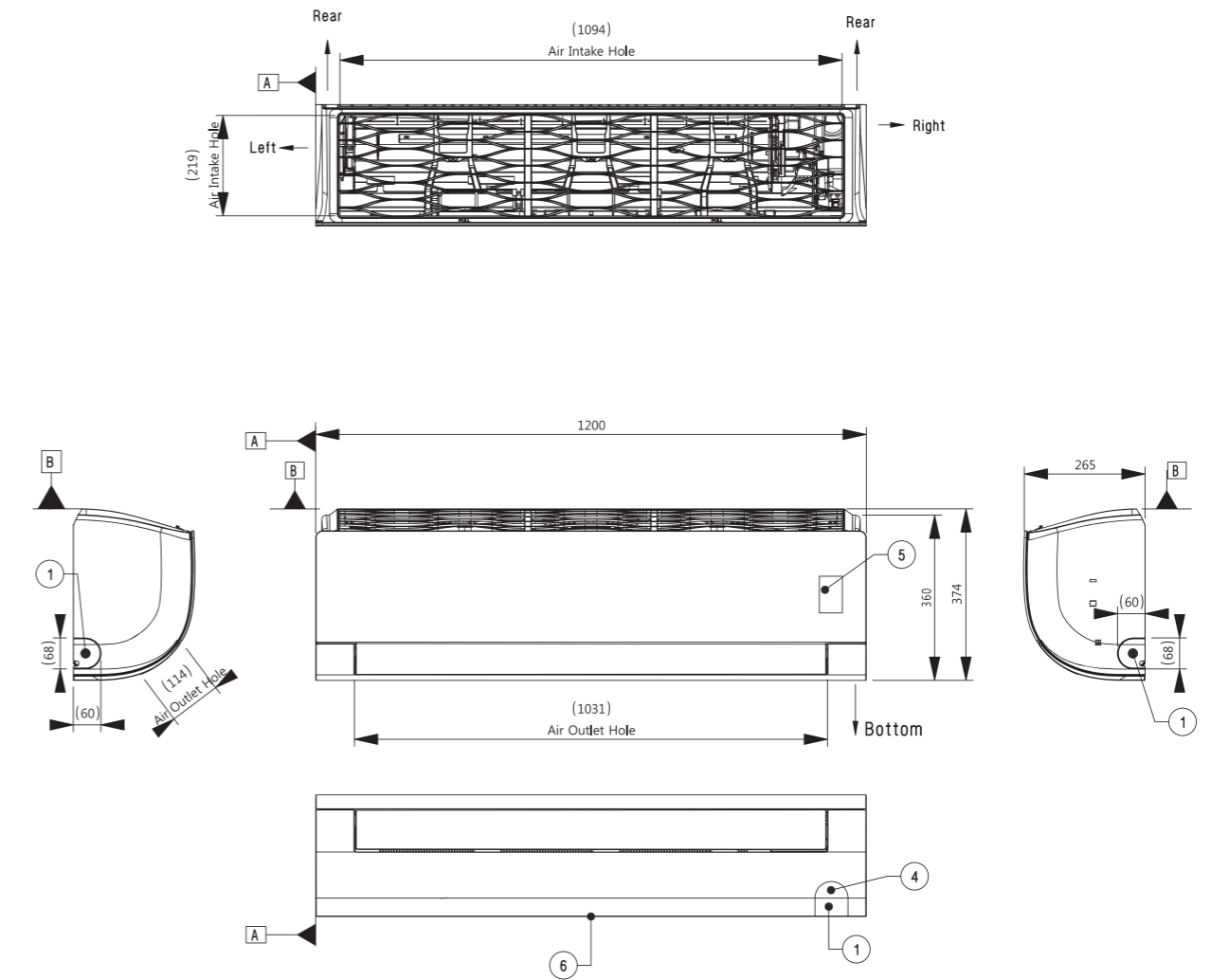

STANDARD INVERTER (R410A)

UP48 NT2

(Unit : mm)

	PART NAME
1	Front Air Discharge Grille
2	Display & Single Receiver
3	Air Suction Grille

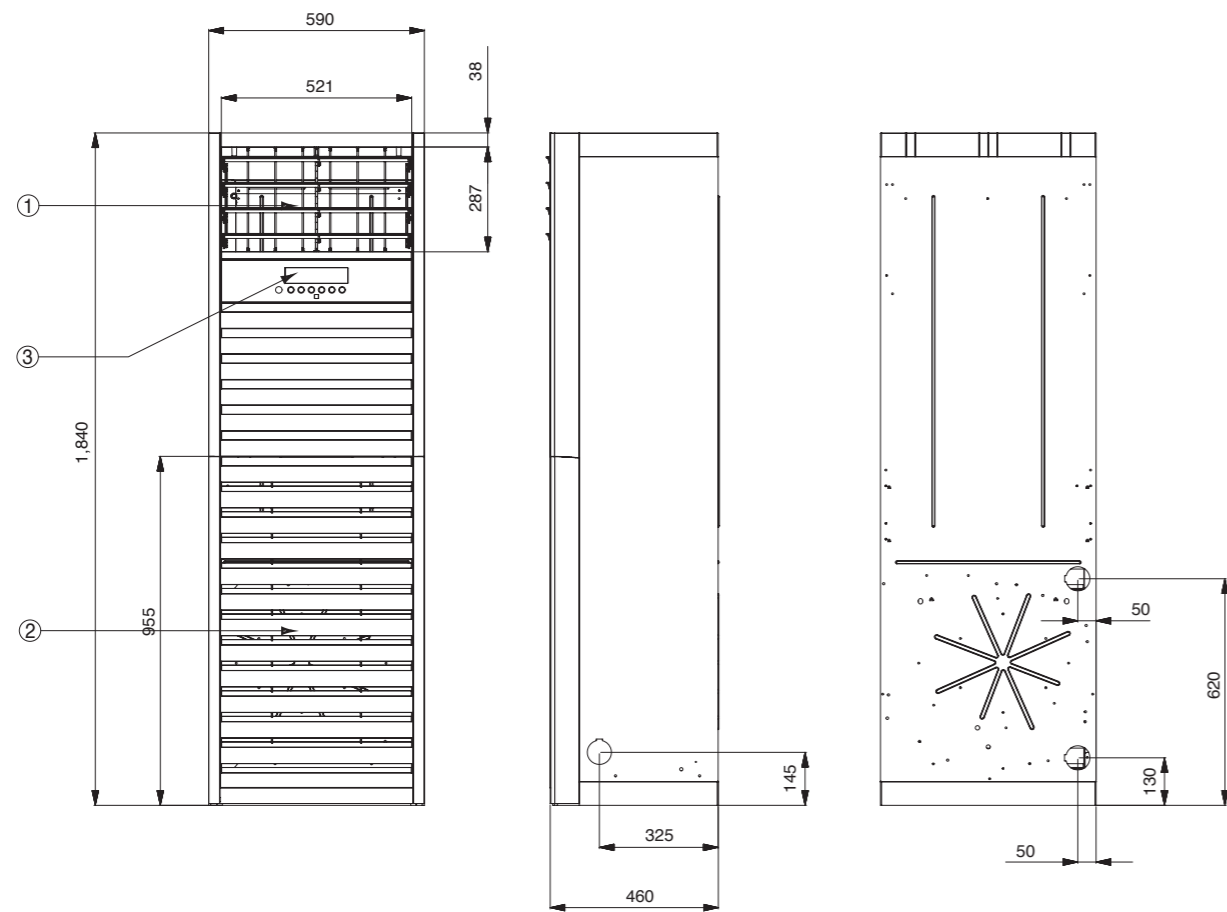

HIGH / STANDARD / COMPACT INVERTER (R32)

UUA1 UL0

(Unit : mm)

	PART NAME
1	Air Outlet
2	Control Cover & SVC Valve Cover
3	Power and Communication Cable Connection
4	Gas Pipe Connection
5	Liquid Pipe Connection
6	Power and Communication Cable Routing hole
7	Refrigerant Pipe Routing Hole
8	Handle
9	Intake Air Temperature Sensor Cover

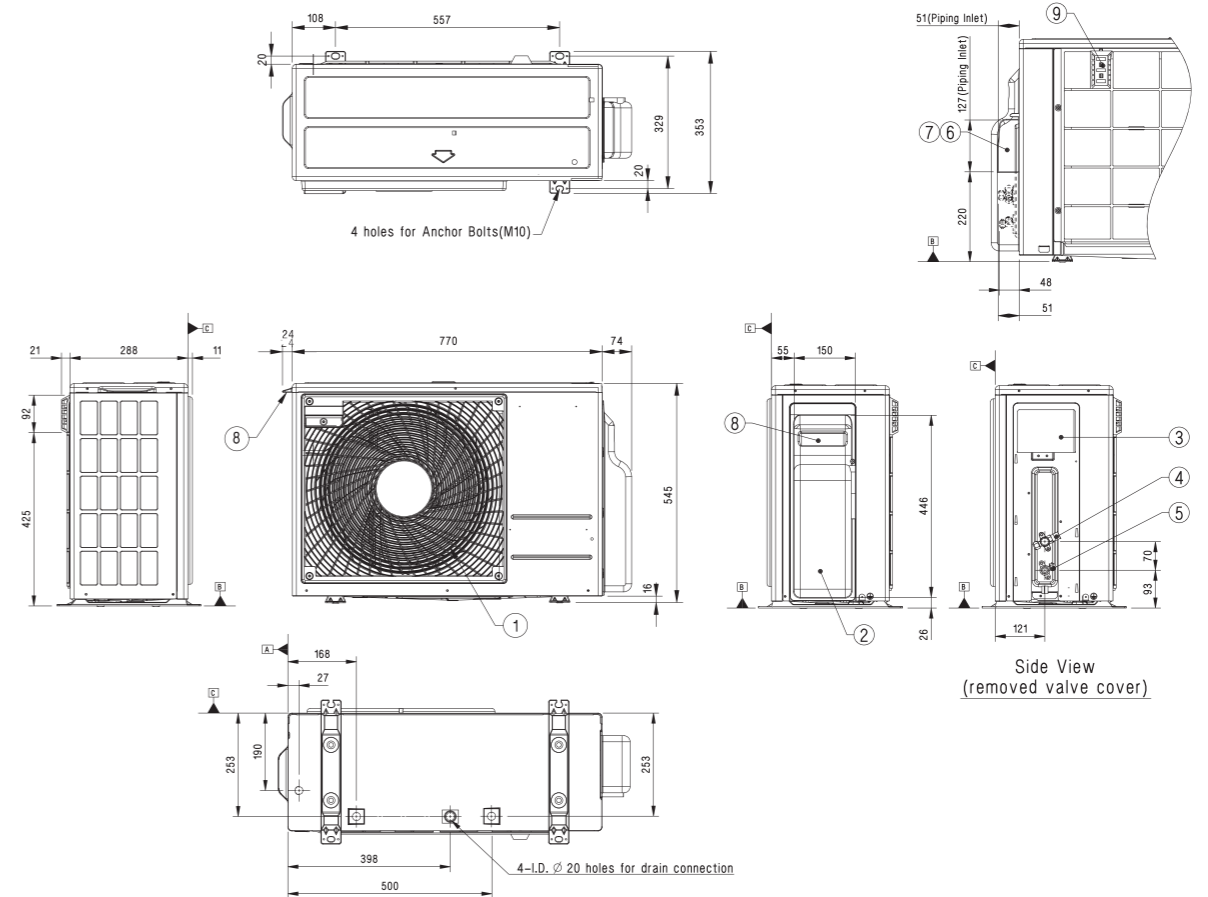
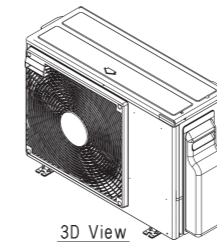

HIGH / STANDARD / COMPACT INVERTER (R32)

UUB1 U20

(Unit : mm)

PART NAME	
1	Air Outlet
2	Control Cover & SVC Valve Cover
3	Power and Communication Cable Connection
4	Gas Pipe Connection
5	Liquid Pipe Connection
6	Handle
7	Intake Air Temperature Sensor Cover

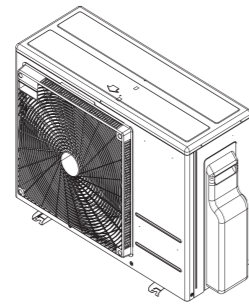

3D View

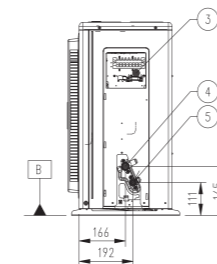
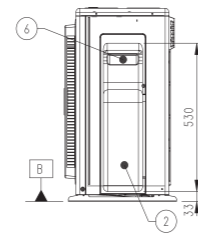
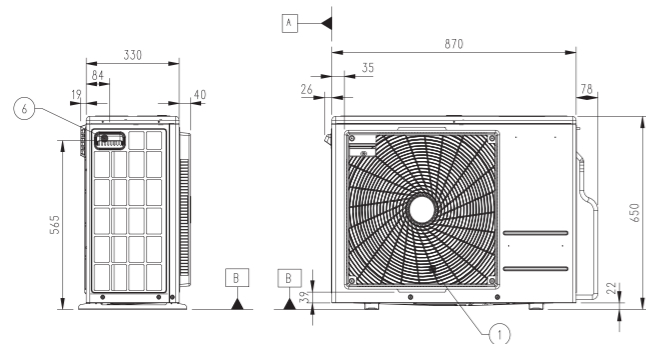
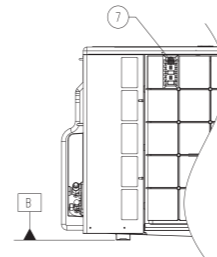
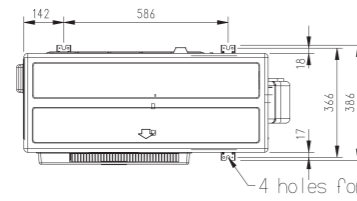

Side View (removed valve cover)

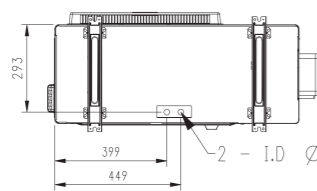

2 - I.D. Ø 20 Holes for drain connection

HIGH / STANDARD / COMPACT INVERTER (R32)

UUC1 U40

(Unit : mm)

PART NAME	
1	Air Outlet
2	Power and Communication Cable Hole
3	Gas Pipe Connection
4	Liquid Pipe Connection
5	Handle
6	Pipe Routing Hole (Front)
7	Pipe Routing Hole (Side)
8	Pipe Routing Hole (Back)

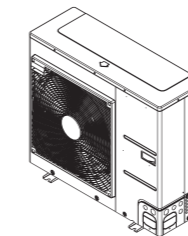

3D View

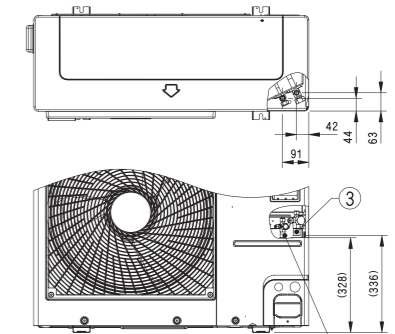
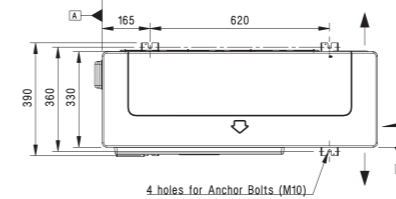

Piping connection port

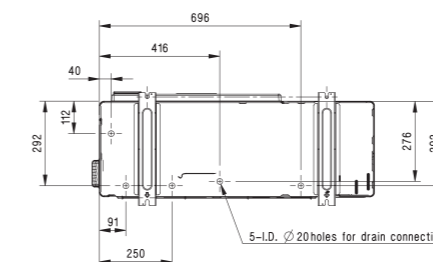
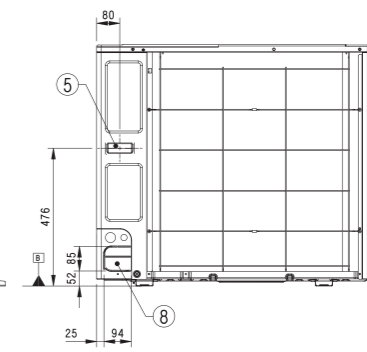
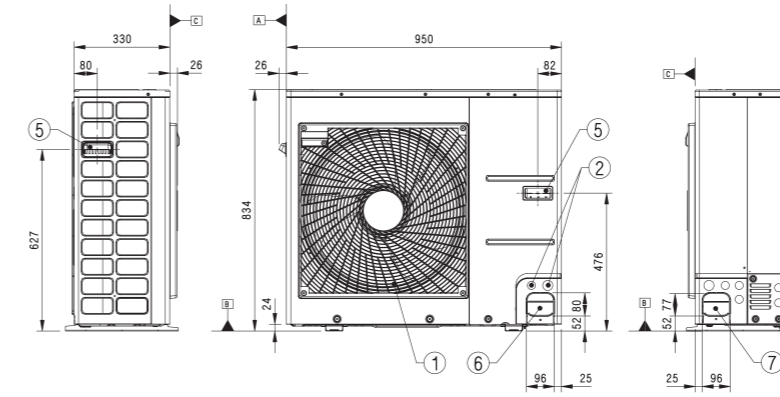

5-I.D. Ø 20 holes for drain connection

STANDARD INVERTER (R32)

UUD1 U30 / UUD3 U30

(Unit : mm)

PART NAME
1 Air Outlet
2 Power and Communication Cable Hole
3 Gas Pipe Connection
4 Liquid Pipe Connection
5 Handle
6 Pipe Routing Hole (Front)
7 Pipe Routing Hole (Side)
8 Pipe Routing Hole (Back)

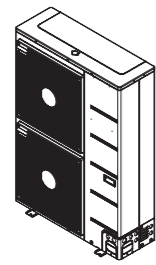

3D View

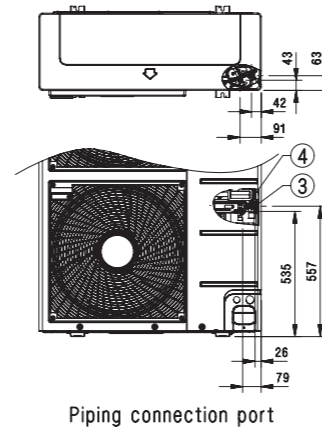
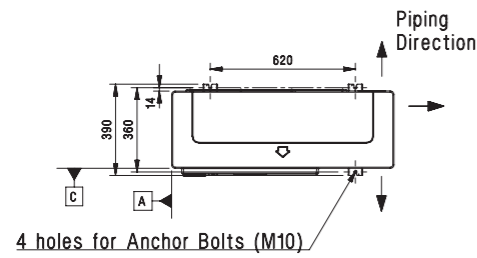

Piping connection port

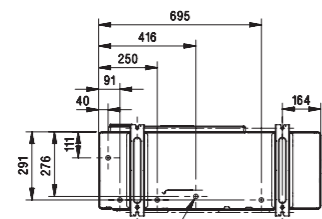
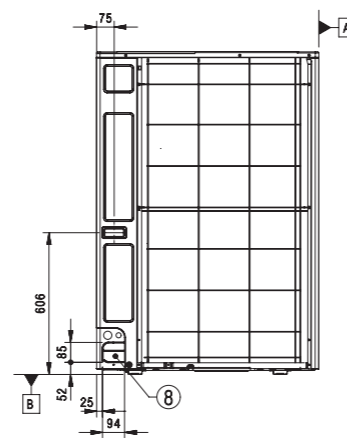
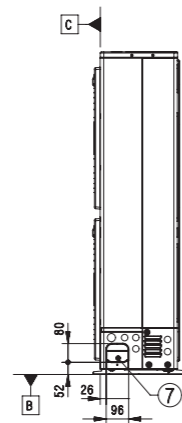
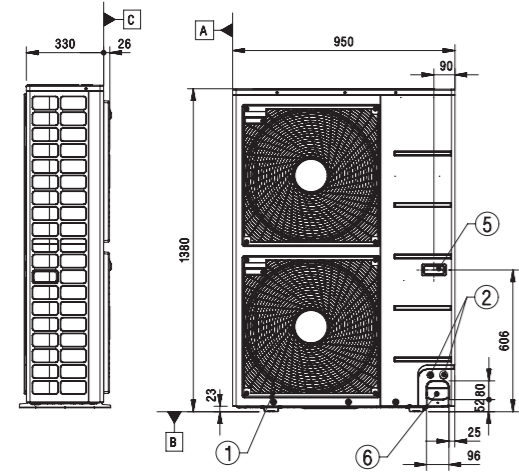

5-L.D. \varnothing 20 holes for drain connection

STANDARD INVERTER (R410A)

UU48W U32 / UU49W U32

(Unit : mm)

PART NAME
1 Air Outlet
2 Power and Communication Cable Hole
3 Gas Pipe Connection
4 Liquid Pipe Connection
5 Handle
6 Pipe Routing Hole (Front)
7 Pipe Routing Hole (Side)
8 Pipe Routing Hole (Back)

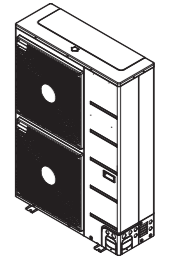

3D View

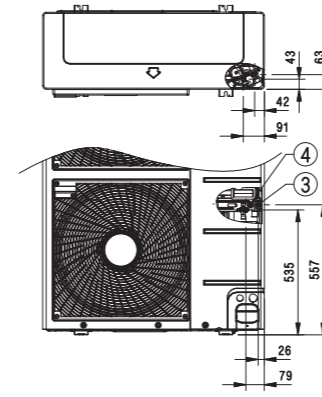
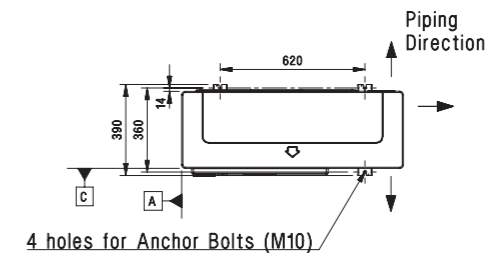

Piping connection port

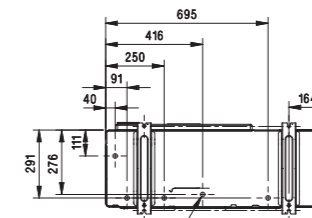
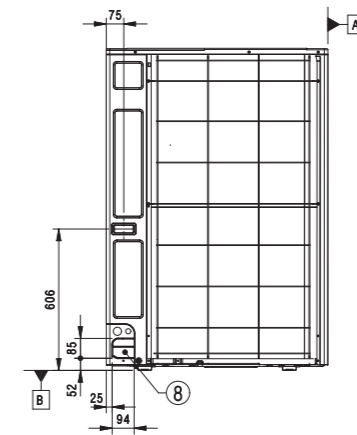
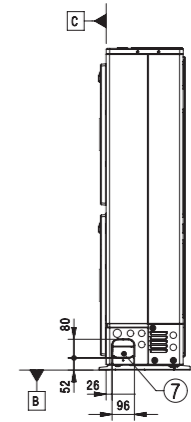
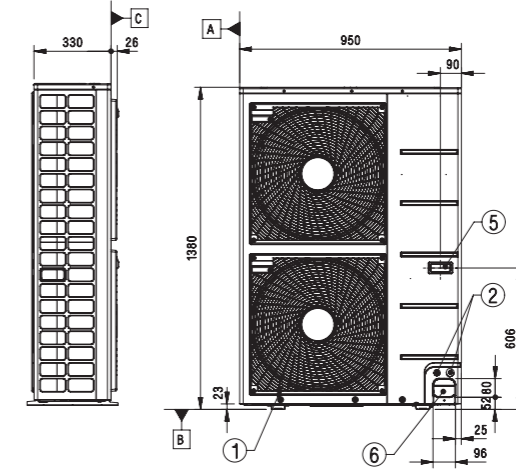

5-L.D. \varnothing 20 holes for drain connection

